

# BALLUFF

sensors worldwide

## Industrial Networking and Connectivity

System Technology

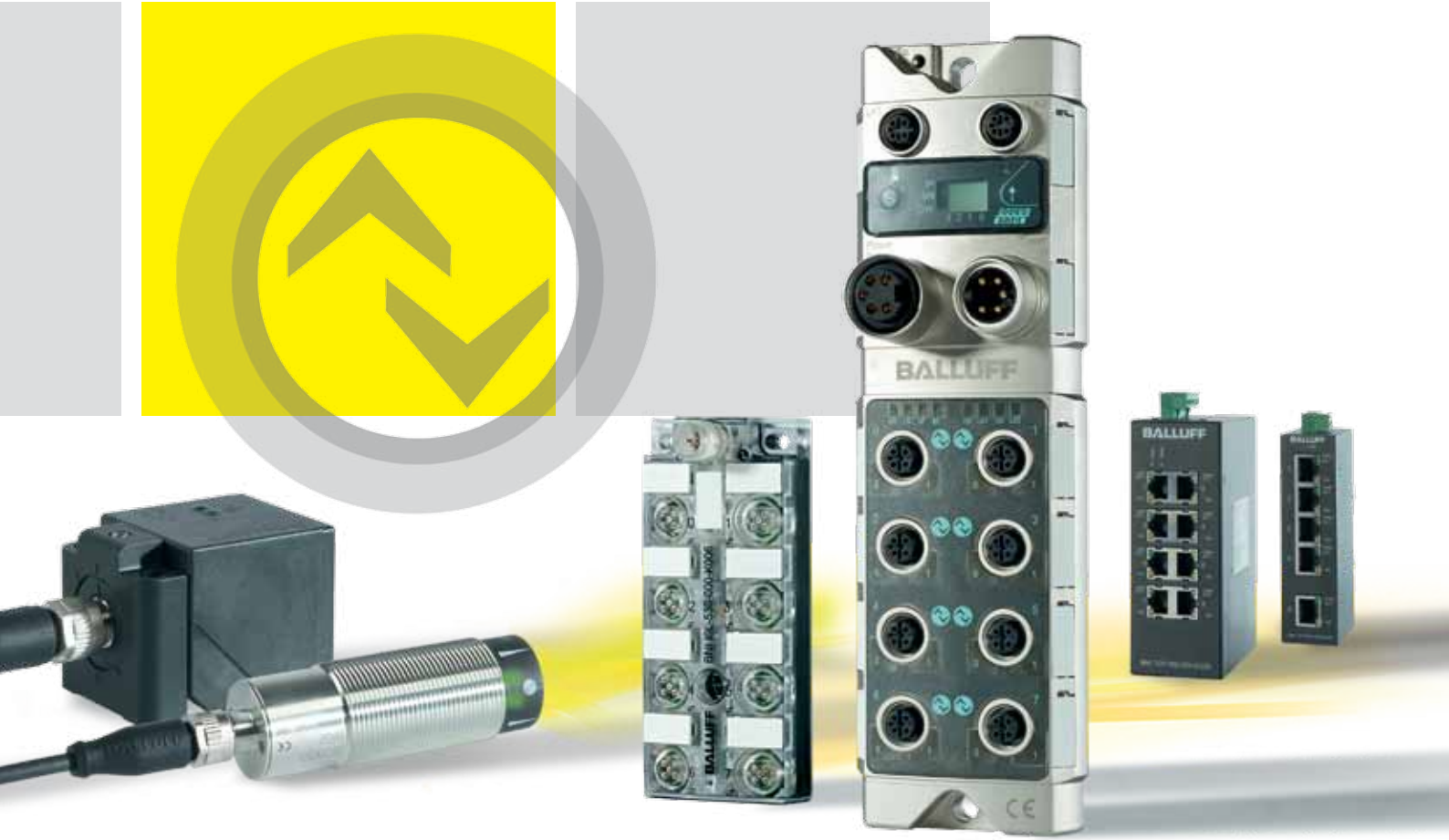



With over 50 years of sensor experience, Balluff is a leading global sensor specialist with its own line of connectivity products for every area of factory automation. Balluff is based in Germany and has a tight international network of 54 representatives and subsidiaries.

**Fully exploit the potential of high quality. With intelligent, comprehensive network solutions.**

Balluff stands for comprehensive systems from a single source, continuous innovation, state-of-the-art technology, highest quality, and greatest reliability. That's not all: Balluff also stands for exceptional customer orientation, customized solutions, fast worldwide service, and outstanding application assistance.



Secure foundation for optimized value creation at the customer. High-quality, innovative products tested in our own accredited laboratory and a quality management system certified according to DIN EN ISO 9001:2008 form a secure foundation for optimized added value for our customers.



Whether electronic and mechanical sensors, rotary and linear transducers, identification systems or optimized connection technology for high-performance automation, Balluff masters not only the entire technological variety with all of the different operating principles, but also provides technology that can be used worldwide. After all, it also fulfills regional standards. Wherever you are in the world, Balluff technology is never far away. You won't have to look far for your nearest Balluff expert.

Balluff products increase performance, quality and productivity around the world every day. They provide the basic conditions for meeting the demands of the global market for increased performance and reduced costs. Even in the most demanding areas. No matter how stringent your requirements may be, Balluff delivers state-of-the-art solutions.





**Fieldbus systems** 14  
 Profibus, Profinet, CC-Link, Devicenet, Ethernet/IP,  
 Unmanaged switches

**IO-Link** 132

**Dynamic sensor control** 192

**Inductive couplers** 202

**Passive splitters** 240

**Plug connectors and valve connectors** 260  
 Connectors, connection cables, valve connectors

**Power supplies** 358

**Basic information and definitions** 384

Alphanumerical directory 390  
 Worldwide sales 418

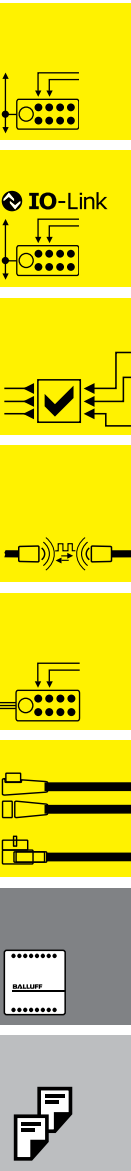

# Customized Services

## Balluff stands for comprehensive systems from a single source

### Systems and service, industrial networking and connectivity, industrial identification:

Industrial RFID systems, vision sensors, fieldbus modules, passive splitters, inductive couplers, IO-Link, plug connectors and connecting cables

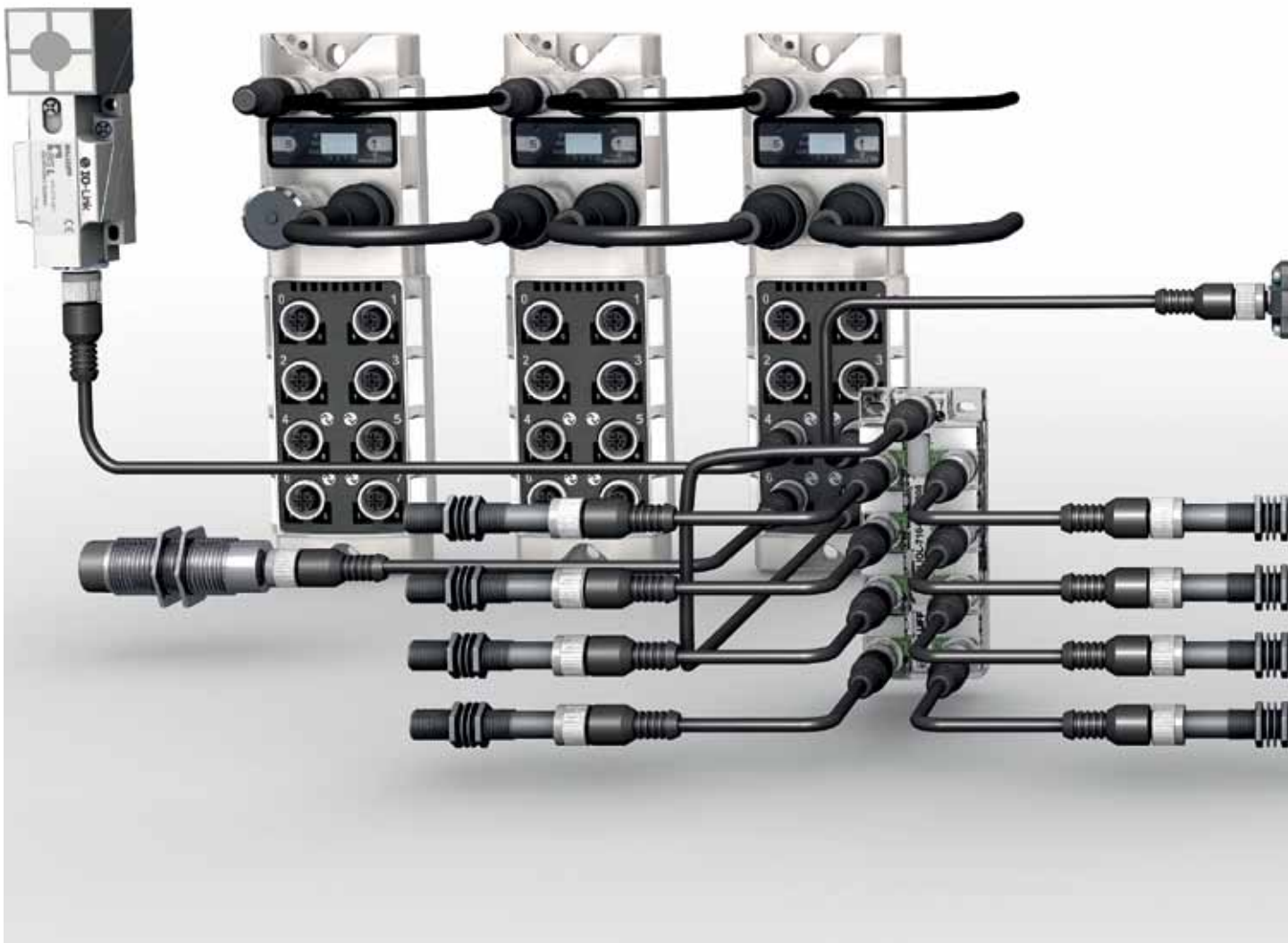
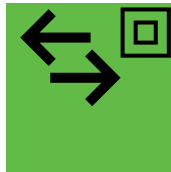
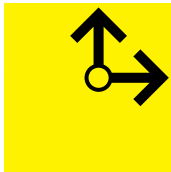
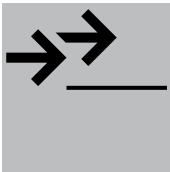

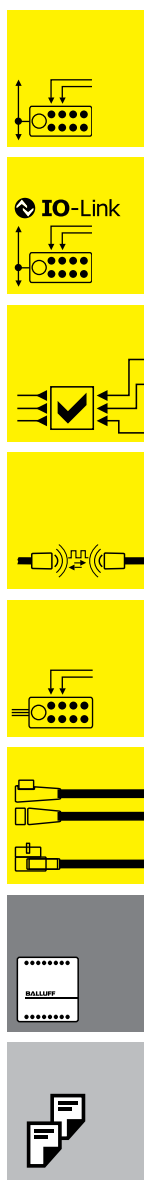
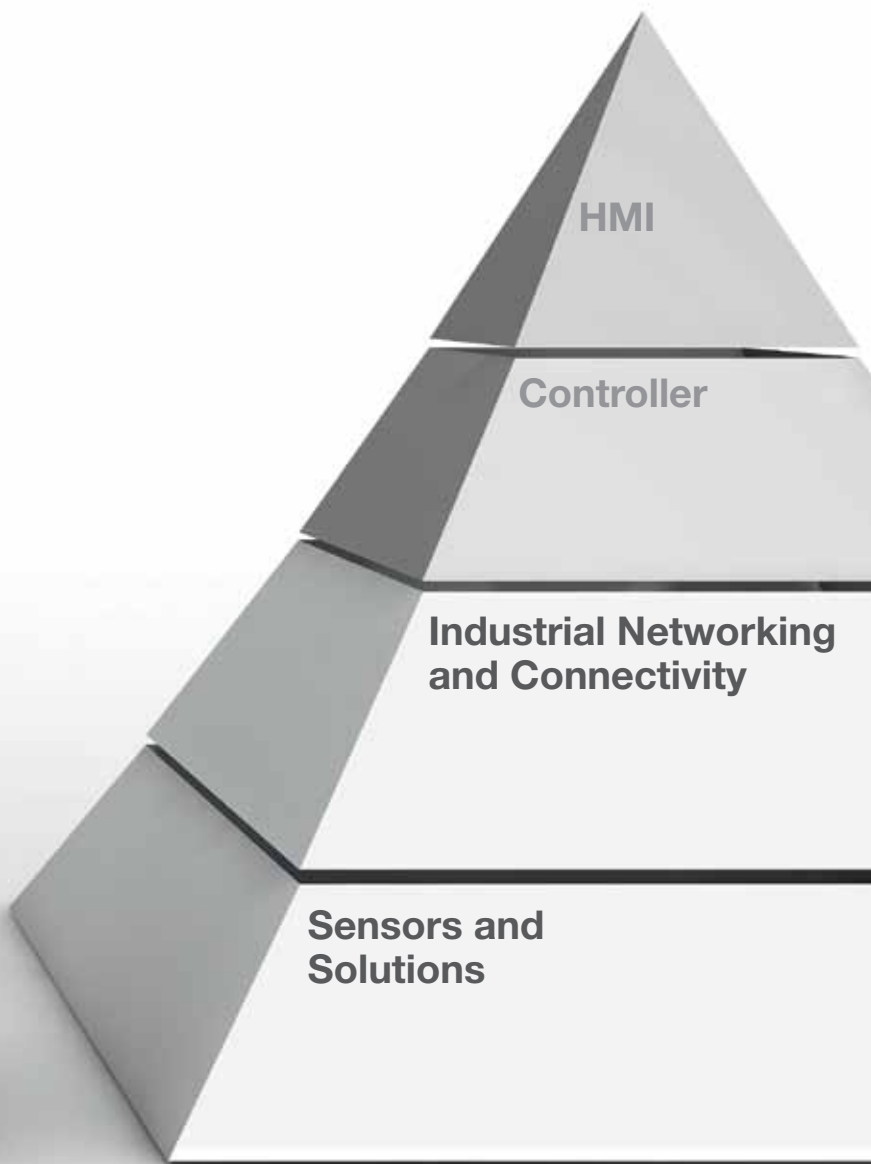

# Sensor Solutions

## Balluff offers suitable products for every application

### Object detection, linear position sensing and measurement, condition monitoring and fluid sensors, accessories:

Inductive sensors, capacitive sensors, magnetic sensors, photoelectric sensors, mechanical sensors, ultrasonic sensors, inductive distance sensors, magneto-inductive displacement sensors, micropulse transducers, photoelectric distance sensors, magnetically coded position and angle measurement systems, inductive positioning systems, pressure sensors, mechanical accessories, electrical accessories

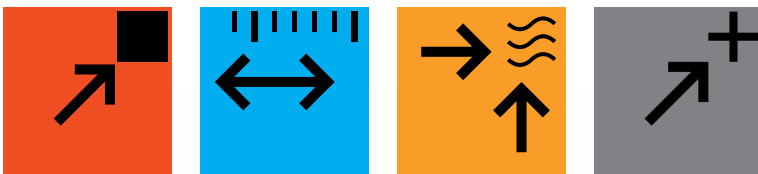



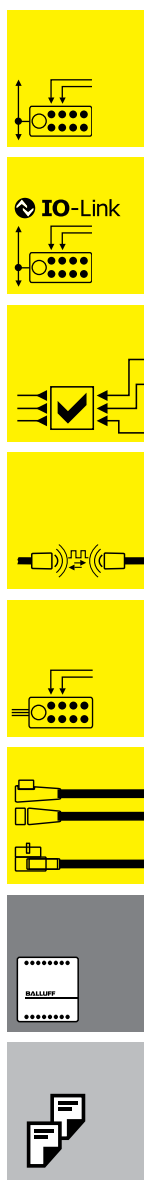
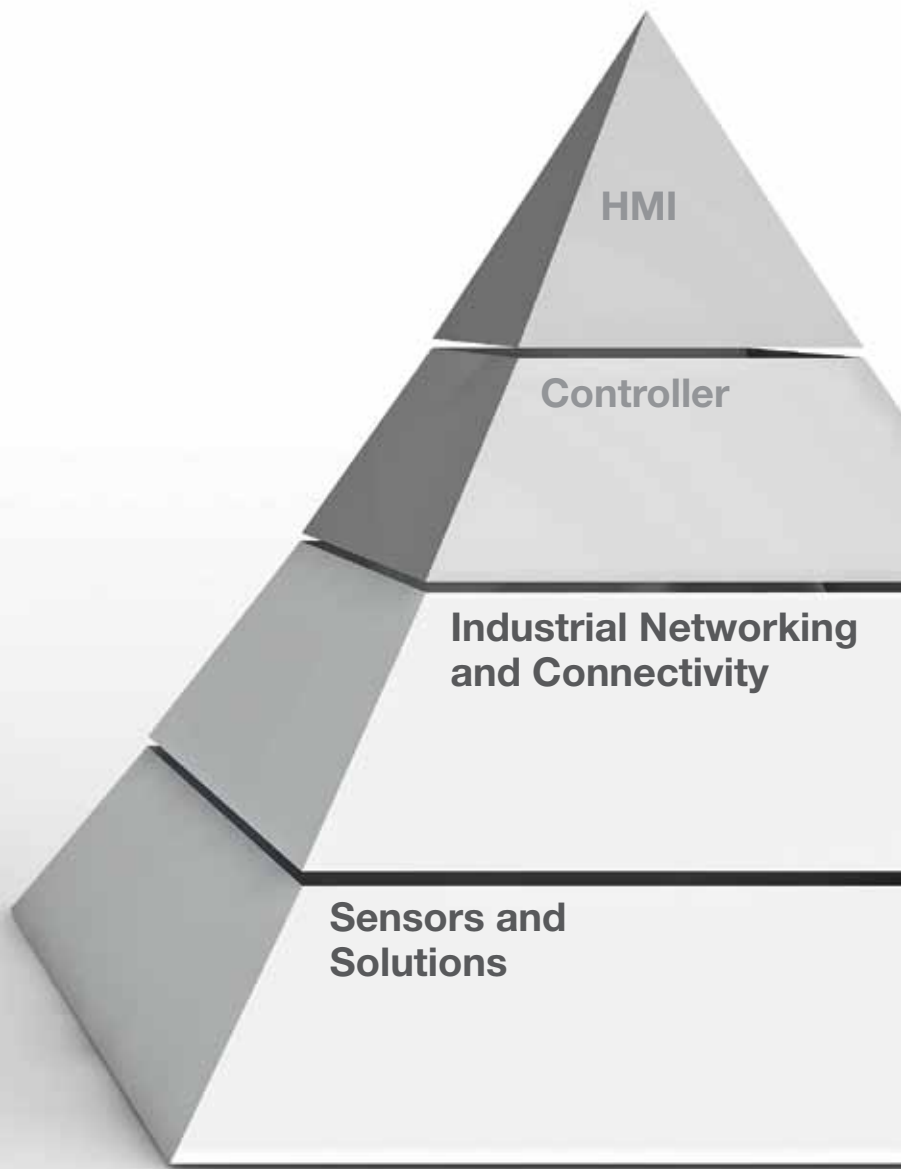

# Convenient Online Access to the Latest Information

## The most up-to-date information available online worldwide

- Data sheets
- CAD drawings in 2D or 3D
- Catalogs
- Brochures
- Manuals
- Software descriptions
- User's guides
- Worldwide addresses

### ■ Products in overview



### ■ 2D and 3D product data



### ■ Current information at a glance



### ■ Company



### ■ Service and support



### ■ We are happy to help



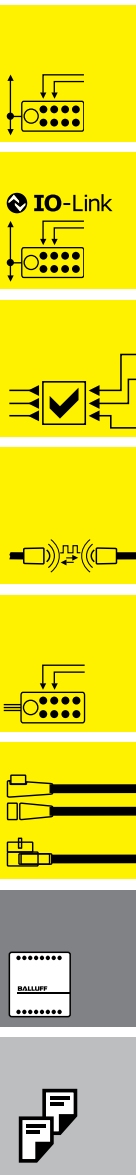
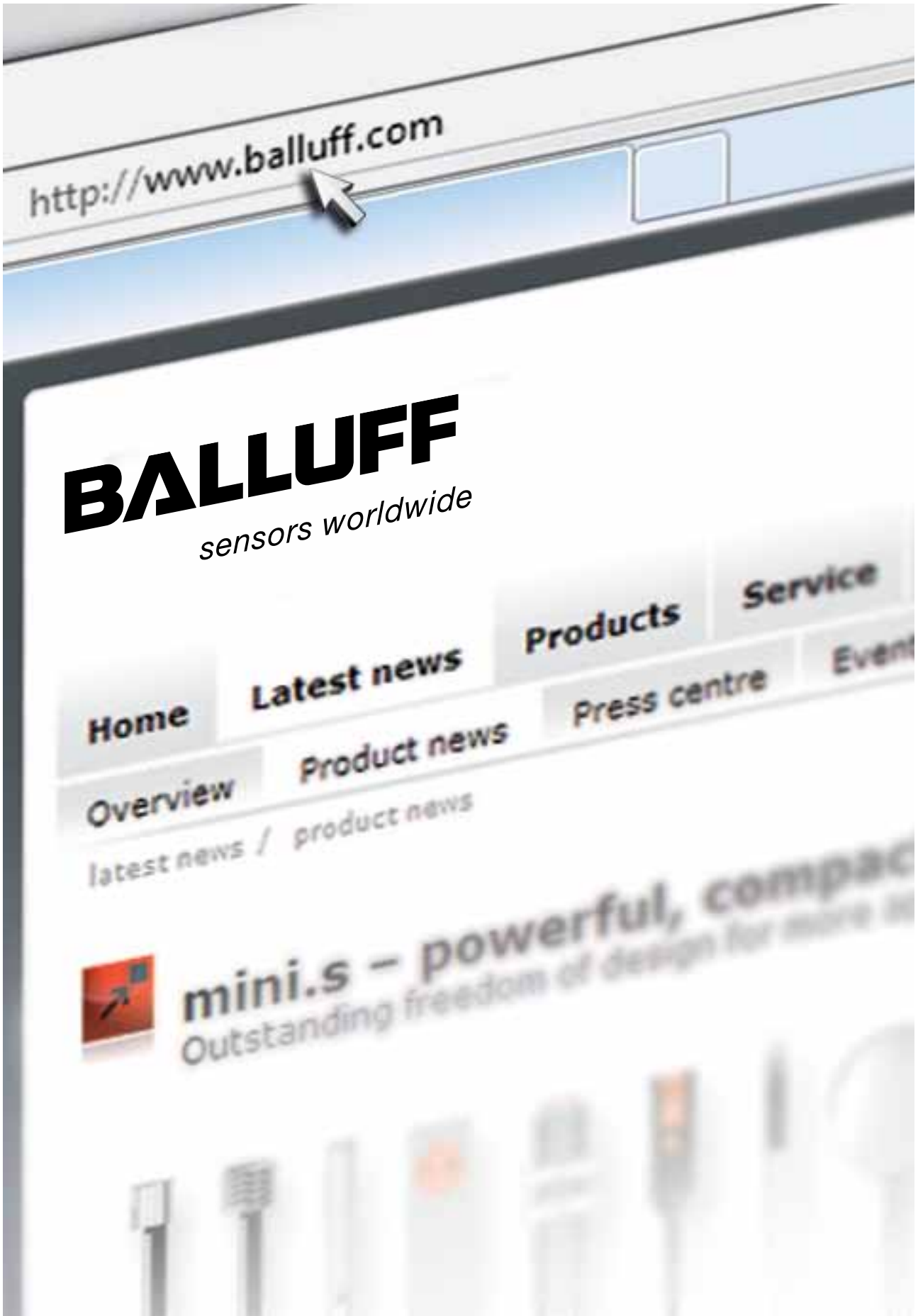

# Matrix



	BNI005R BNI PBS-502-101-Z001		BNI0047 BNI PBS-302-101-Z001		BNI005C BNI PBS-104-101-Z001		BNI0057 BNI PBS-202-101-Z001		BNI0064 BNI PBS-551-001-Z001		BNI0065 BNI PBS-552-001-Z001		BIS00T3 BIS V-6102-019-C001		BNI003P BNI PBS-507-002-Z001		BNI0030 BNI PBS-504-002-K008	
Special features	8 ports 4x IO-Link		8 ports		8 ports		8 ports		8 ports 4x P111 interface		8 ports 4x P111 interface		8 ports 4x RFID interface		4 ports 4x IO-Link		4 ports 4x IO-Link	
<b>Modules</b>																		
No. of ports	8		8		8		8		8		8				4		4	
Max. inputs	16		16		16		8		8						8		4	
Max. outputs	16		16												8		4	
Configurable max. inputs/outputs	16		16															
Analog input U/I											4							
Max. IO-Link ports	4												1		4		4	
IO-Link version	1.1												1.1		1.1		1.1	
<b>Page</b>	22		23		23		23		24		24		163		26		27	



	BNI004A BNI EIP-502-105-Z015		BNI006A BNI EIP-508-105-Z015		BNI004F BNI EIP-302-105-Z015		BNI004M BNI EIP-104-105-Z015		BNI005J BNI EIP-202-105-Z015		BNI0044 BNI EIP-307-100-Z014		BNI0014 BNI EIP-104-100-Z016		BNI0018 BNI EIP-105-100-Z010		BNI0015 BNI EIP-202-100-Z016		BNI0016 BNI EIP-206-100-Z016		BNI0017 BNI EIP-305-100-Z016		BNI0019 BNI EIP-306-100-Z010	
Special features	8 ports 4x IO-Link		8 ports 8x IO-Link		8 ports		8 ports		8 ports		4 ports		8 ports		16 ports		8 ports		8 ports		8 ports		16 ports	
<b>Modules</b>																								
No. of ports	8		8		8		8		8		4		8		16		8		8		8		16	
Max. inputs	16		16		16		16		8		8		16		32		8		16		8		16	
Max. outputs	16		16		16		8		8		8				8		16		8		8		16	
Configurable max. inputs/outputs			16		16						8													
Analog input U/I																								
Max. IO-Link ports	4		8																					
IO-Link version	1.1		1.1																					
<b>Page</b>	102		102		103		103		103		103		104		104		105		105		105		104	





# Matrix



## IO-Link

Special features	M8, 3-pin																M8, 3-pin																M8, 3-pin																M8, 3-pin																M8, 4-pin																M8, 4-pin																M12, metal																M12, metal																M12, metal																M12, metal																M12, metal																M12, metal																M12, metal															
Sensor hubs	BNI IOL-101-000-K018				BNI IOL-101-S01-K018				BNI IOL-102-000-K019				BNI IOL-102-S01-K019				BNI IOL-104-000-K021				BNI IOL-104-S01-K021				BNI IOL-104-000-Z012				BNI IOL-302-000-Z012				BNI IOL-104-S01-Z012				BNI IOL-104-S01-Z012-C01				BNI IOL-302-S01-Z012				BNI IOL-104-S01-Z012-C02				BNI IOL-302-S01-Z013				BNI IOL-302-S01-Z013-C01				BNI IOL-302-000-Z013				BNI IOL-252-000-Z013				BNI IOL-256-000-Z013																																																																																																																																															
No. of ports	4				4				8				8				16				16				16				16				16				16				16				16				16				16				16				16																																																																																																																																																			
Max. inputs	4				4				8				8				16				16				16				16				16				16				16				16				16				16				16				16																																																																																																																																																			
Max. outputs																																																																																																																																																																																																																
Configurable max. inputs/outputs																																																																																																																																																																																																																
Analog input I																																																																																																																																																																																																																
Analog input U																																																																																																																																																																																																																
Analog output I																																																																																																																																																																																																																
Analog output U																																																																																																																																																																																																																
IO-Link version	1.0				1.0				1.0				1.0				1.0				1.0				1.0				1.0				1.0				1.0				1.0				1.0				1.0				1.0				1.0				1.0																																																																																																																																																			
Page	140				142				140				142				141				143				145				145				146				146				147				147				147				147				145				149				149																																																																																																																																															



## IO-Link

Type	Fork Sensors				Color sensors				Laser distance sensors				Inductive distance sensors				Industrial RFID systems with read unit				Industrial RFID systems with read/write unit			
IO-Link version	1.0				1.0				1.0				1.0				1.0/1.1				1.0/1.1			
Page	157				158				159				160				164				166			



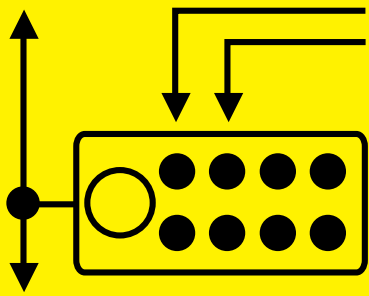

# Fieldbus Systems

Fieldbus systems in industrial automation





Overview of fieldbus systems

### Profibus

Product topology	
IO-Link modules	
Modules	
IO-Link modules	
Power cables	
Bus cables	
Bus plugs	
Flange plug and socket	
Power connectors	
Bus connectors	
Power tee	
Terminating resistor	
Accessories	

16	<b>Profinet</b>	
	Product topology	42
	IO-Link modules	46
20	Modules	47
22	Power cables	48
23	Bus couplings	50
26	Bus cables	52
28	Bus connectors	54
30	Power connectors	56
31	Power tee	57
32	Accessories	58
34		
35	<b>CC-Link</b>	
36	Product topology	62
36	IO-Link modules	64
38	Modules	64
	Power cables	66
	Bus cables	68
	Bus connectors	69
	Power tee	70
	Terminating resistor	70
	Accessories	71
	<b>Devicenet</b>	
	Product topology	74
	IO-Link modules	76
	Modules	77
	Bitmaps	79
	Bus cables	80
	Power cables	82
	Bus terminating resistors	86
	Bus tees	87
	Power tees	88
	Power plug connectors	89
	Accessories	90
	Analyzer	92
	<b>Ethernet/IP</b>	
	Product topology	96
	IO-Link modules	102
	Modules	103
	Bus connection cables	106
	Bus couplings	110
	Bus connectors	112
	Power tee	114
	Power cables	116
	Power connectors	120
	Accessories	122
	Bitmaps	124
	Technical data	125
	Display	126
	<b>Unmanaged switch</b>	
	Port switch	130
	Ethernet switch	131

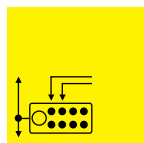

# Fieldbus Systems

## Overview of fieldbus systems

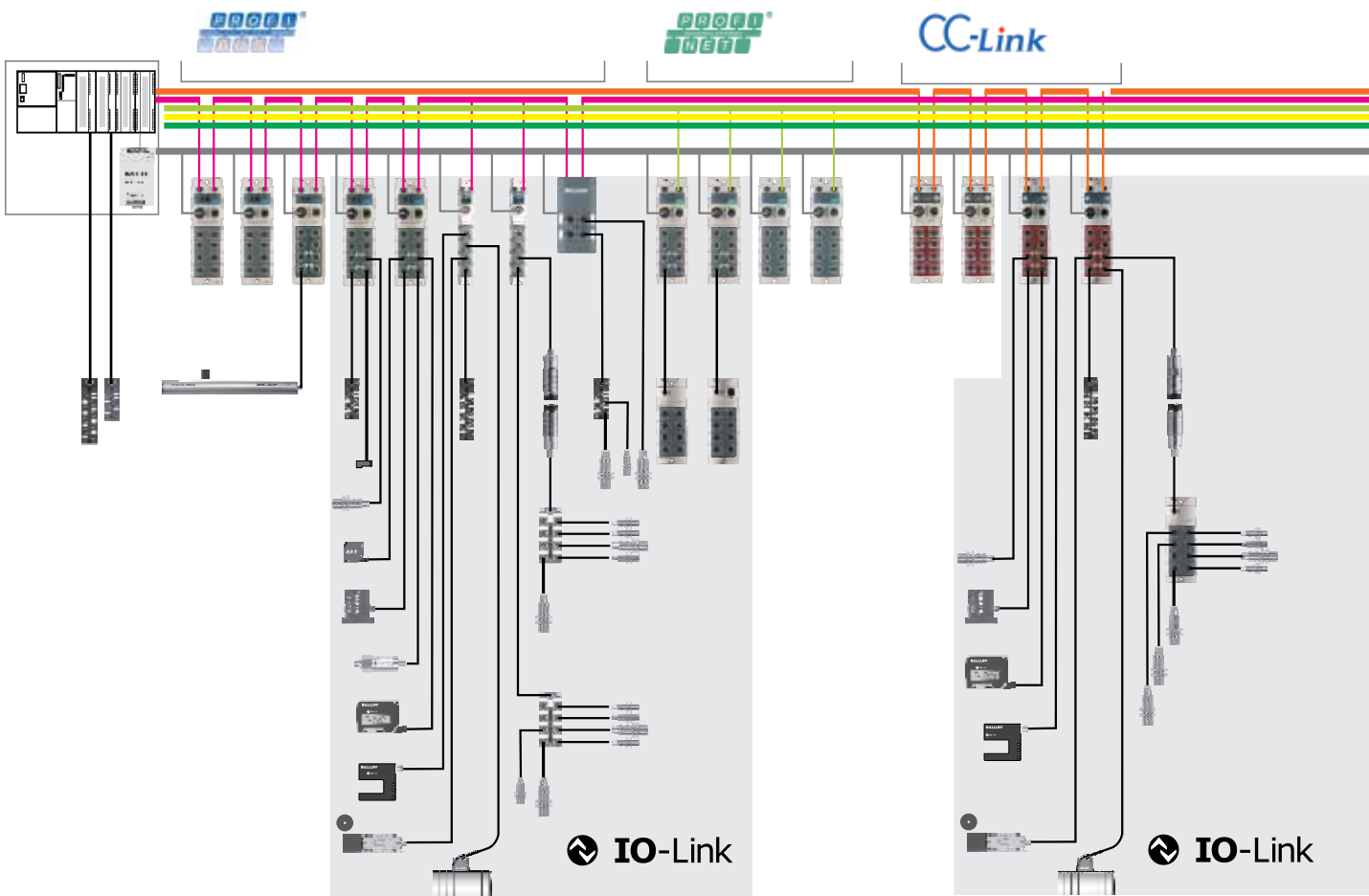

### Bus systems in industrial automation

Network	Profibus	Profinet	CC-Link	Devicenet	Ethernet	Ethernet/IP
Number of nodes	126	No limit	64	64	No limit	No limit
Cable	2-wire	4-wire, twisted	3-wire	5-wire	4-wire, twisted	4-wire, twisted
Transfer rate	9.6 kbs to 12 Mbs	10 Mbs 100 Mbs 1000 Mbs	156 kbs 625 kbs 2500 Mbs	125 kbs 250 kbs 500 kbs	10 Mbs 100 Mbs 1000 Mbs	10 Mbs 100 Mbs 1000 Mbs
Termination	2 terminating resistors at each end	Not necessary	1 terminating resistor at each end	1 terminating resistor at each end	1 terminating resistor at each end	Not necessary
Power supply	Separate	Separate	Separate	Via network cable	Separate	Separate
Maximum length	1200 m	100 m	1200 m	500 m	100 m	100 m

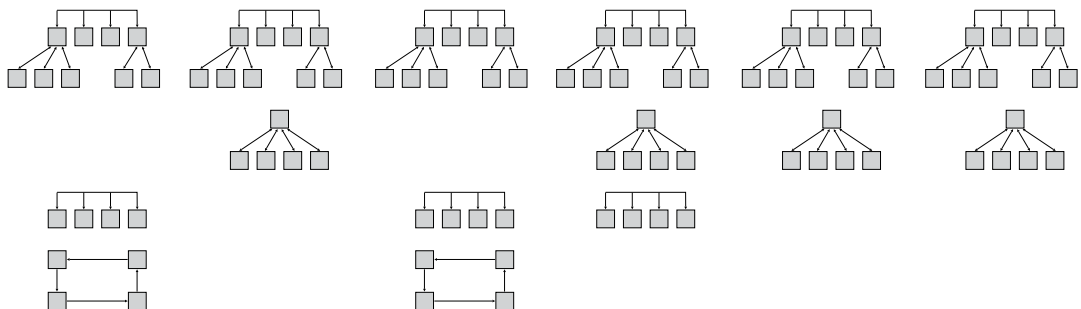

# Fieldbus Systems

## Overview of fieldbus systems

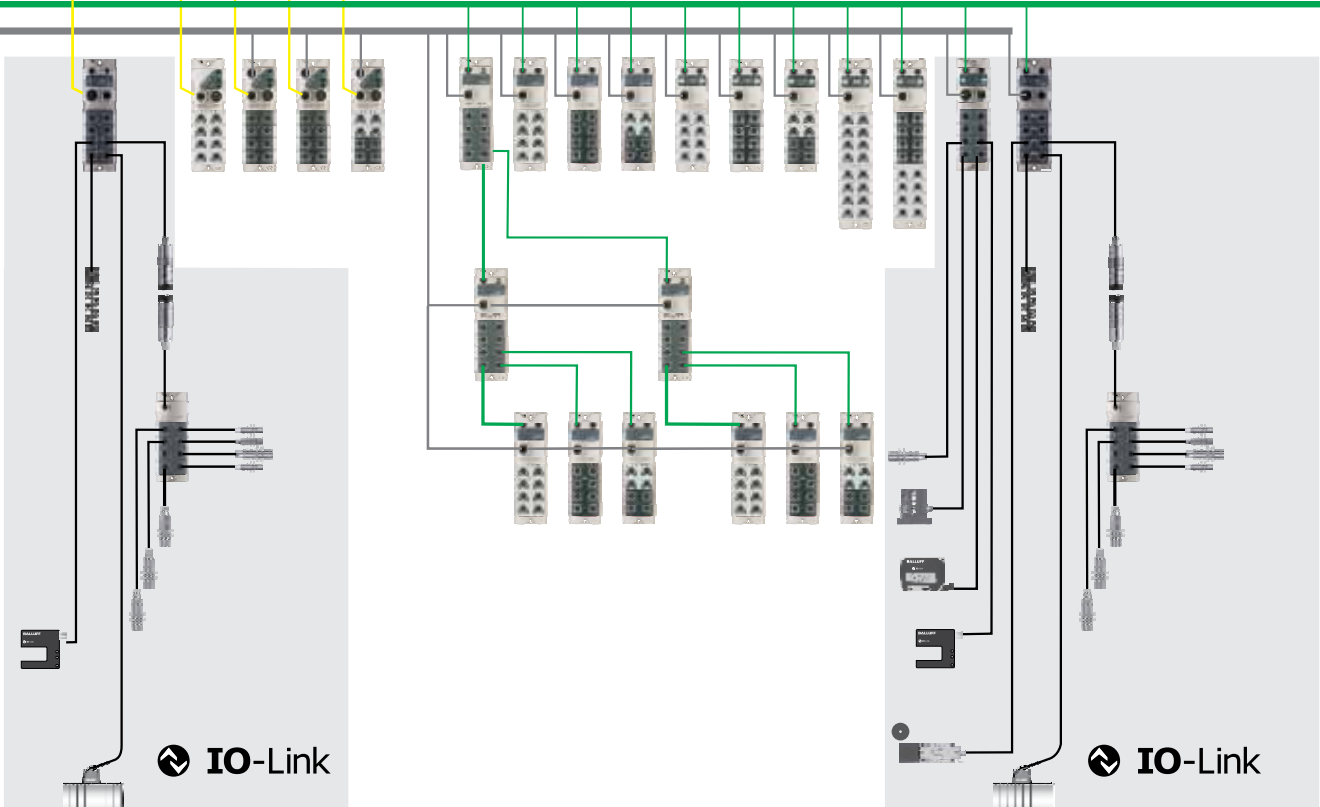
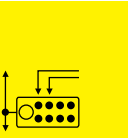

### Bus topologies

#### Tree

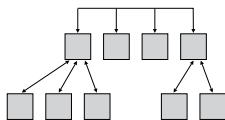

#### Star

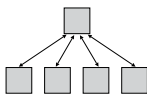

#### Bus

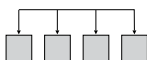

#### Ring

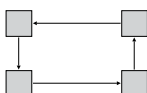

### Benefits +

- **Minimum wiring effort**
- **Each node has its own connection**
- **Good visual implementation**
- **Simple cabling**
- **Extended networks possible**

### Disadvantages -

- Active/passive couplers may be necessary
- Total length may be excessive in some cases
- Complex star couplers
- Communication only via star coupler
- Electrical compromise when bus termination used
- Limited number of bus nodes and bus length
- Failure of one node means complete failure of the network

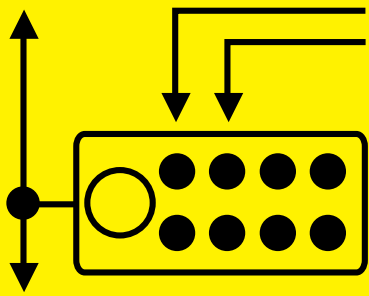

# Fieldbus Systems





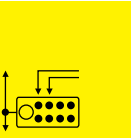

Product topology	20
IO-Link modules	22, 26
Modules	23
Power cables	28
Power connectors	34
Power tee	36
Bus cables	30
Bus plugs	31
Bus connectors	35
Flange plug and socket	32
Terminating resistor	36
Accessories	38

## Fieldbus System: Profibus

In use for years, Profibus stands for well-engineered fieldbus technology and reliably supports modern manufacturing. As a full-service provider, Balluff offers a wide range of components for optimum Profibus use. Regardless of controller manufacturer, Balluff has the perfect solution in store for you: for efficient field and process communication with simple wiring and fast integration through direct installation in your system and the possibility of fast modifications. Even in harsh environments.

Balluff Profibus solutions are IO-Link capable, allowing you to take advantage of solid IO-Link benefits. Wiring is made even simpler. Integrated diagnostics prevent system failure and the central configuration quickly returns systems to operation. You save time and benefit from real cost advantages.

In addition, Profibus offers investment security, since standard IEC 61158/EN 50170 simplifies expansion of your system.

With mature connection technology, Balluff contributes to increased efficiency and growing cost savings.

# Profibus

## Product topology

### Trunk and drop lines

- Very simple troubleshooting
- A single device can be disconnected without disrupting the network
- Extra cable requirements result in higher costs

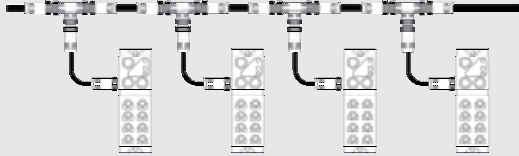

### Connected in series

- Difficult troubleshooting
- Disconnecting a device interrupts the network
- Lower costs due to fewer cabling components

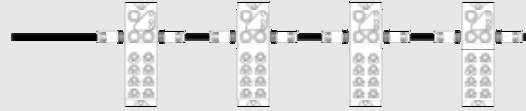

### Mixed topology

- Creation of logical groups results in relatively simple troubleshooting
- Popular method – ideal cost/benefit ratio

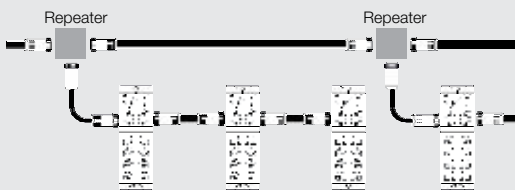

## The best I/O modules in the industry

Impressive features. Impressive functionality. Impressive performance

### Clearly visible status LEDs

Low-quality LEDs that are often difficult to identify under demanding production conditions perform poorly when used in high-speed applications. Unlike Balluff status LEDs, which are large, bright, highly visible and provide maximum assistance. Balluff quality will help you complete setup and maintenance tasks and reduce machine downtimes with ease.



### Powerful and reliable outputs

With an output current of up to **2 A**, Balluff output modules are capable of driving almost any load. Each output also offers an overload protection with LED indicator and a memory feature for easy troubleshooting.

### Robust, full-metal housing

The fully encapsulated housing can withstand impacts, shaking, corrosive fluids, as well as people stepping on it and costs no more than a plastic housing.



### Display

A firmly entrenched part of the module is a display that can be locked via the PLC, which prevents unauthorized access. Two LEDs controlled by the PLC allow you to visualize results that are not specific to the module or port at the location where they occur.

### Inputs with high density

All Balluff input blocks offer two input points for each connector, accessed via a V splitter. A DESINA output is also optionally available via pin 2.

### Innovative housing design

The extra-flat profile reduces potential dangers posed by cables. Rounded corners offer highly visible locations for channel markers and two mounting points are sufficient to secure the robust metal housing.

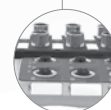

# Profibus Product topology

High-quality connectors and compatible accessories are required to create an efficient Profibus system. Balluff offers all the components you need for optimally setting up a Profibus network and providing it with first-class support.

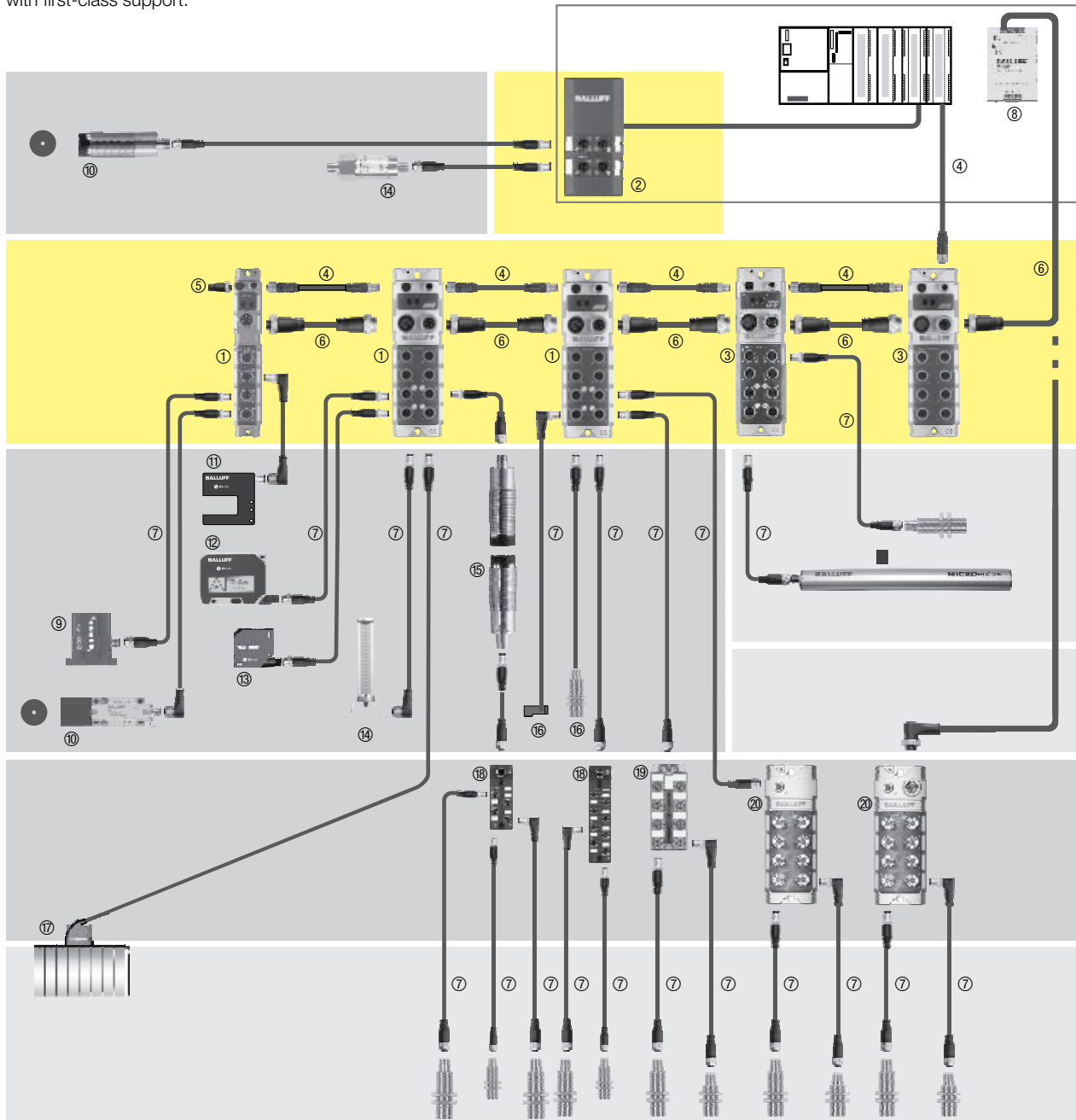

Profibus  
**Product topology**  
IO-Link modules  
Modules  
Power cables  
Power connectors  
Power tee  
Bus cables  
Bus plugs  
Bus connectors  
Flange plug and socket  
Terminating resistor  
Accessories  
Profinet  
CC-Link  
Devicenet  
Ethernet/IP  
Unmanaged switches

- ① Profibus IO-Link module BNI Page 22
- ② Profibus IO-Link panel module BNI Page 27
- ③ Profibus module BNI Page 23
- ④ Bus cable BCC Page 30
- ⑤ Terminating resistor Page 36
- ⑥ Power cable BCC Page 28
- ⑦ Connection cable BCC Page 336
- ⑧ Power supplies BAE Page 365

## IO-Link

- ⑨ IO-Link multiple-position switch BNS Page 171
- ⑩ IO-Link RFID system BIS Page 164
- ⑪ IO-Link fork sensor BGL Page 157
- ⑫ IO-Link laser distance sensor BOD Page 159
- ⑬ IO-Link color sensor BFS Page 158
- ⑭ IO-Link SmartLight BNI Page 187
- ⑮ IO-Link inductive couplers BIC Page 210
- ⑯ IO-Link inductive distance sensor BAW Page 160
- ⑰ IO-Link valve terminal connector BNI Page 180
- ⑱ IO-Link sensor hub BNI M8 Page 140
- ⑲ IO-Link sensor hub BNI M12 Page 145
- ⑳ Metal IO-Link sensor hub Page 146

# Profibus IO-Link modules

The Balluff Profibus interface ensures optimum operation of IO-Link modules as well as acyclical operation of Profibus DP V1.

The module includes four IO-Link master ports that can be configured and used fully independently of one another. All IO-Link ports support COM1, COM2, COM3 (3-wire only) as well as SIO mode.

The IO-Link ports also include an additional input or input/output via pin 2. This means that SIO mode also enables the connection of complementary NO/NC and DESINA sensors.

You get four additional standard IO ports with eight inputs or eight freely configurable inputs/outputs for standard sensors and actuators up to **2 A**.

In addition to time savings and considerable cost savings, it provides even greater ease of operation. Balluff provides Profibus modules with a display that you can use to set station numbers or call up module information such as the hardware and software status. This increases security and simplifies maintenance.



Fieldbus	Profibus
Version	4x IO-Link, 16x DI/DO
<b>Ordering code</b>	<b>BNI005R</b>
Part number	BNI PBS-502-101-Z001
Supply voltage $U_B$	18...30 V DC
Indicator/input	BUS/RUN
Function indicator	Display/pushbutton
Module status indicator: Mod LED	Yes
Network status indicator: Net LED	Yes
Port status indicator	Black, red, yellow
Connection: Fieldbus	M12, B coded, socket/plug
Connection: AUX power	7/8", plug, 5-pin
Connection: I/O ports	M12, A-coded, female
No. of I/O ports	8
Number of inputs	Max. 16 PNP
Number of outputs	Max. 16 PNP
Configurable inputs/outputs	Yes
Max. load current, sensors/channel	200 mA
Max. load current, output	1.6 A/2 A
Port status indicator (signal status)	Yellow LED
Port diagnostic indicator (overload)	Red LED
Total current $U_{Actuator}$	≤ 9 A
Total current $U_{Sensor}$	≤ 9 A
Degree of protection as per IEC 60529	IP 67 (when screwed into place)
Operating temperature $T_a$	-5...+70 °C
Storage temperature	-25...+70 °C
Fastener	2 mounting holes
Dimensions (LxWxH)	225x68x36.9 mm
Housing material	Nickel-plated GdZn

### IO-Link Version 1.1

No. of IO-Link master ports	4x master
Operating modes (3-wire)	SIO, COM 1, COM 2, COM 3
Indicators	Communication
	Error
Max. load current for IO-Link device	1.6 A

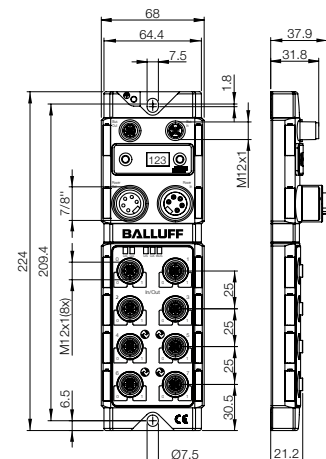

All modules include four screw plugs and a label set.

# Profibus Profibus Gen II



Profibus  
Product topology  
**IO-Link modules**  
**Modules**  
Power cables  
Power connectors  
Power tee  
Bus cables  
Bus plugs  
Bus connectors  
Flange plug and socket  
Terminating resistor  
Accessories  
Profinet  
CC-Link  
Devicenet  
Ethernet/IP  
Unmanaged switches

Profibus	Profibus	Profibus	
16x DI/DO, configurable	16 DI	8 DO	
<b>BNI0047</b>	<b>BNI005C</b>	<b>BNI0057</b>	
BNI PBS-302-101-Z001	BNI PBS-104-101-Z001	BNI PBS-202-101-Z001	
18...30 V DC	18...30 V DC	18...30 V DC	
BUS/RUN	BUS/RUN	BUS/RUN	
Display/pushbutton	Display/pushbutton	Display/pushbutton	
Yes	Yes	Yes	
Yes	Yes	Yes	
Black, red, yellow	Black, red, yellow	Black, red, yellow	
M12, B coded, socket/plug	M12, B coded, socket/plug	M12, B coded, socket/plug	
7/8", plug, 5-pin	7/8", plug, 5-pin	7/8", plug, 5-pin	
M12, A-coded, female	M12, A-coded, female	M12, A-coded, female	
8	8	8	
Max. 16 PNP	16 PNP	8 PNP	
Max. 16 PNP			
Yes	No	No	
200 mA	200 mA		
2 A		2 A	
Yellow LED	Yellow LED	Yellow LED	
Red LED	Red LED	Red LED	
≤ 9 A		≤ 9 A	
≤ 9 A			
IP 67 (when screwed into place)	IP 67 (when screwed into place)	IP 67 (when screwed into place)	
-5...+70 °C	-5...+70 °C	-5...+70 °C	
-25...+70 °C	-25...+70 °C	-25...+70 °C	
2 mounting holes	2 mounting holes	2 mounting holes	
225x68x36.9 mm	225x68x36.9 mm	175x68x36.9 mm	
Nickel-plated GdZn	Nickel-plated GdZn	Nickel-plated GdZn	

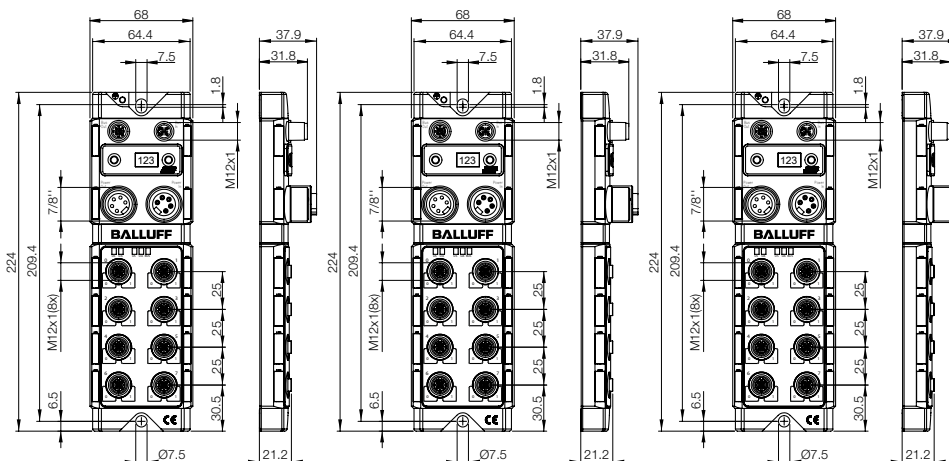

## P111 module for the cost-effective integration of micropulse transducers BTL

Profibus modules P111 are designed for connecting micropulse transducers, the robust position measuring systems for extreme ambient conditions that can be used universally. Thanks to their durable metal housing, Profibus modules P111 meet the highest mechanical requirements and are ideally suited for use in the harsh industrial environment. The modules are fitted with four interdependent ports for micropulse transducers BTL.

A maximum of 16 encoders can be used per BTL port. With a maximum rated length of 7500 mm. Four additional ports can be configured with digital or analog sensors, depending on the version.

You can achieve maximum functionality and cost efficiency for fieldbus integration by combining Micropulse transducers BTL with Profibus modules P111.



Digital inputs



Analog inputs



Fieldbus Version	Profibus 4x P111, 8x DI	Profibus 4x P111, 4x AI (0...10 V/4...20 mA)
<b>Ordering code</b>	<b>BNI0064</b>	<b>BNI0065</b>
Part number	BNI-PBS-551-001-Z001	BNI-PBS-552-001-Z001
Supply voltage $U_B$	18...30 V DC	18...30 V DC
Function indicator	BUS RUN	BUS RUN
Fault function indicator	Red LED	
Power-on indicator	$V_A$ , $V_S$ , undervoltage	$V_A$ , $V_S$ , undervoltage
Connection: Fieldbus	M12, B-coded	M12, B-coded
Supply voltage connection	7/8", 5-pin, female and male	7/8", 5-pin, female and male
Connection: I/O ports	M12, A-coded, 5-pin, female	M12, A-coded, 5-pin, female
Connection: P111 port	M12, A-coded, 8-pin, female	M12, A-coded, 8-pin, female
No. of I/O ports	8	8
No. of digital inputs	8 PNP	
No. of analog inputs		4 (0...10 V/4...20 mA)
No. of P111 inputs	4	4
Max. load current, sensors/channel	1 A	1 A
Port status indicator (signal status)	Yellow LED	Yellow LED
Port diagnostic indicator (overload)	Red LED	Red LED
Total current $U_{Sensor}$	9 A	9 A
Degree of protection as per IEC 60529	IP 67 (when screwed into place)	IP 67 (when screwed into place)
Operating temperature $T_a$	0...+70 °C	0...+70 °C
Weight	Approx. 735 g	Approx. 735 g
Fastener	2 mounting holes	2 mounting holes
Dimensions (LxWxH)	224x68x36.9	224x68x36.9
Housing material	Nickel-plated GD-Zn, matt finish	Nickel-plated GD-Zn, matt finish

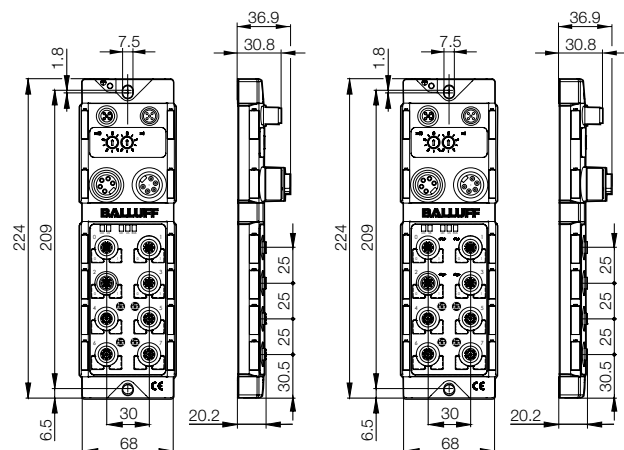

All modules include four screw plugs and a label set.





# Profibus

## P111 module for the cost-effective integration of micropulse transducers BTL

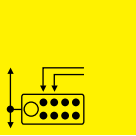

- Profibus
- Product topology
- IO-Link modules
- Modules**
- Power cables
- Power connectors
- Power tee
- Bus cables
- Bus plugs
- Bus connectors
- Flange plug and socket
- Terminating resistor
- Accessories
- Profinet
- CC-Link
- Devicenet
- Ethernet/IP
- Unmanaged switches

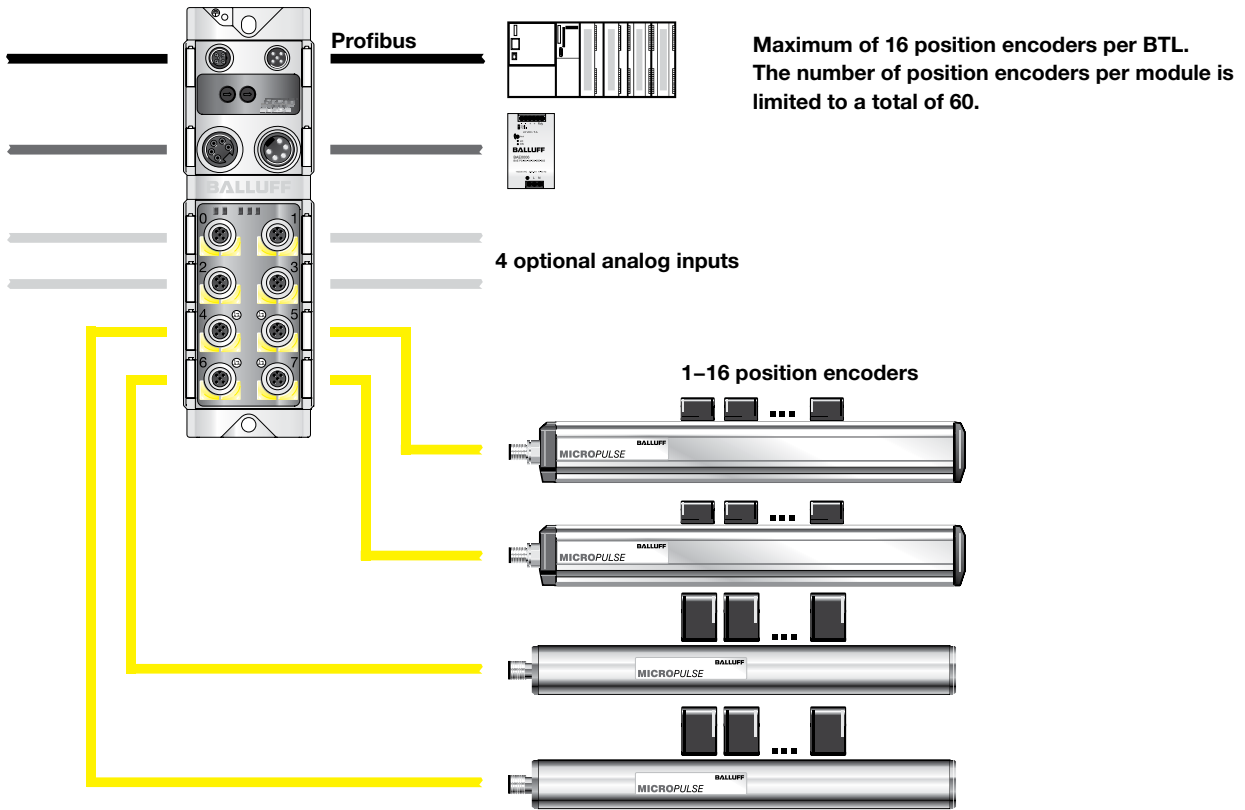

#### IO-Link master for tight spaces – robust and compact

The Profibus IO-Link master is the first choice for tight spaces and applications where there is dust, water, oils, or a risk of mechanical damage. The slim splitter in the rugged metal housing is particularly durable.

With its small size and versatility, it is well-suited for IO-Link-capable sensors, such as pressure or distance sensors. Or if you want to connect sensor hubs, operating panels or actuators (valve cluster units). For the perfect connection of mini-masters we provide compact, molded mini-plug connectors.

The Profibus IO-Link master is available with two or four IO-Link interfaces, which means you can connect up to 68 sensors in combination with IO-Link sensor hubs.

Unused IO-Link ports can be used as standard inputs or outputs. Thus, the system is used to its fullest when space is at a premium.

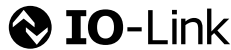

Fieldbus	Profibus DP	
IO-Link	Master	
Version	4x IO-Link ports, max. 8 DI/DO	
<b>Ordering code</b>	<b>BNI003P</b>	
Part number	BNI-PBS-507-002-Z011	
Supply voltage $U_B$	18...30 V DC	
Function indicator	BUS RUN	
Power-on indicator	$V_A$ , $V_S$ , undervoltage	
Connection: Fieldbus	M12, B-coded	
Supply voltage connection	7/8"	
Connection: I/O ports	M12, A-coded, female	
No. of I/O ports	4	
No. of IO-Link ports	Max. 4	
Number of inputs	Max. 8 PNP	
Number of outputs	Max. 8 PNP	
Configurable	Yes	
Max. load current, sensors/channel	200 mA	
Max. load current, output	≤ 1.6 A	
Port status indicator	Yellow LED	
Port diagnostic indicator	Short circuit/overload: red LED	
Total current $U_{Actuator}$	≤ 9 A	
Total current $U_{Sensor}$	≤ 9 A	
Degree of protection as per IEC 60529	IP 67 (when screwed into place)	
Operating temperature $T_a$	-5...+55 °C	
Storage temperature	-25...+70 °C	
Weight	Approx. 355 g	
Fastener	2 mounting holes	
Dimensions (LxWxH)	224x37x32 mm	
Housing material	Nickel-plated GdZn	

#### IO-Link Version 1.1

No. of IO-Link ports	4x master	
Operating modes (3-wire)	SIO, COM 1, COM 2, COM 3	
Communication indicator	Green LED	
Error indicator	Red LED	
Max. load current for IO-Link device	≤ 1.6 A	



The outer diameter of user-fabricated connectors may not exceed 19 mm!

We recommend using:  
1 user-fabricated connector and 1 molded plug connector  
or 2 molded plug connectors.

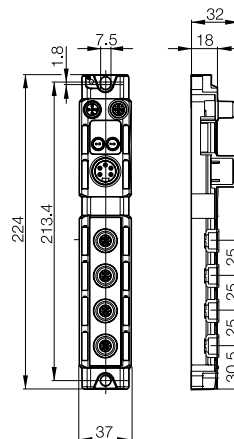

**All modules include four screw plugs and a label set.**

# Profibus Panel module IO-Link panel module for simple installation

## New IO-Link panel module for simple commissioning

Not only are installation and commissioning simplified with the Profibus IO-Link panel module, but cabling is also cost-effective. Developed for small to mid-sized machines and systems, it is ideal for centralized wiring concepts and, with IO-Link sensor hubs, satisfies the demand for modular construction. Now the machine and equipment can be checked before they leave the plant and commissioned on-site with no additional wiring.

The IO-Link panel module is particularly interesting where expensive connectors would otherwise be needed for routing the cables. The module provides four IO-Link ports on the outer panel. Simply connect IO-Link sensor hubs or IO-Link capable sensors here to create efficient, cost-effective connections using standard cables. The power supply and Profibus interface are connected to the inner panel. Another feature: a separate actuator power supply. This allows actuators such as hydraulic valves / pneumatic valve cluster units to be turned off separately.

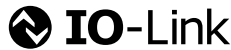

Profibus  
Product topology  
**IO-Link modules**  
Modules  
Power cables  
Power connectors  
Power tee  
Bus cables  
Bus plugs  
Bus connectors  
Flange plug and socket  
Terminating resistor  
Accessories  
Profinet  
CC-Link  
Devicenet  
Ethernet/IP  
Unmanaged switches

Fieldbus	Profibus DP	
Version	4x IO-Link, max. 4 DI	
<b>Ordering code</b>	<b>BNI0030</b>	
Part number	BNI PBS-504-002-K008	
Supply voltage $U_B$	18...30.2 V DC	
Net function indicator	Green LED	
Fault function indicator	Red LED	
Power-on indicator	Sensor module	
Connection: Fieldbus	SUB-D, 9-pin	
Supply voltage connection	Spring terminals	
Connection: I/O ports	M12, A-coded, female	
No. of I/O ports	4	
No. of IO-Link ports	Max. 4	
Number of inputs	max. 4 PNP	
Number of AUX power ports	Max. 4	
Configurable	Yes	
Max. load current, sensors/channel	1.6 A	
Max. load current auxiliary power/channel	3 A	
Port status indicator (signal status)	Yellow LED	
Port diagnostic indicator (overload)	Red LED	
Total current $U_{Sensor}$	$\leq 9$ A	
Degree of protection as per IEC 60529	IP 67 (fitted in panel)	
Operating temperature $T_a$	-5...+55 °C	
Storage temperature	-25...+70 °C	
Weight	Approx. 130 g	
Fastener	4 mounting holes	
Dimensions (W×H)	150.8×75.8 mm	
Lead-in dimensions	112×46 mm	

### IO-Link Version 1.1

No. of IO-Link ports	4x master	
Operating modes (3-wire)	SIO, COM 1, COM 2, COM 3	
Communication indicator	Green LED	
Error indicator	Red LED	
Max. load current for IO-Link device	$\leq 1.6$ A	

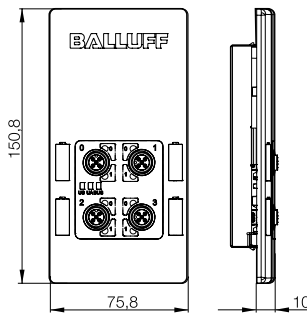

All modules include four screw plugs and a label set.

Reduce your wiring costs by 60%!

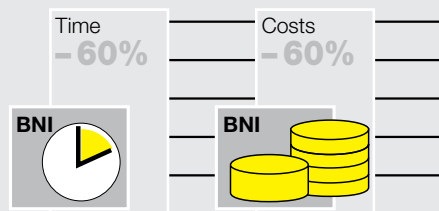



Connector diagram and wiring

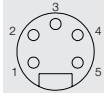

PIN 1: black  
PIN 2: blue  
PIN 3: green/yellow  
PIN 4: brown  
PIN 5: white

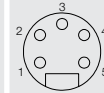
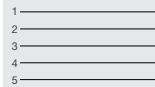

PIN 1: black  
PIN 2: blue  
PIN 3: green/yellow  
PIN 4: brown  
PIN 5: white

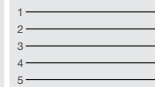

Type	Female	Female
Supply voltage $U_B$	300 V DC	300 V DC
Number of conductors x conductor cross-section	5x1.5 mm <sup>2</sup>	5x1.5 mm <sup>2</sup>
Degree of protection as per IEC 60529	IP 68	IP 68
Ambient temperature $T_a$	-25...+80 °C	-25...+80 °C

Cable material	Color	Length	Ordering code	
PUR	Black	0.6 m	Part number	
PUR	Black	2 m	<b>BCC06HC</b> BCC A315-0000-10-063-PX05A5-020	<b>BCC06HH</b> BCC A325-0000-10-063-PX05A5-020
PUR	Black	5 m	<b>BCC06HE</b> BCC A315-0000-10-063-PX05A5-050	<b>BCC06HJ</b> BCC A325-0000-10-063-PX05A5-050
PUR	Black	10 m	<b>BCC06HF</b> BCC A315-0000-10-063-PX05A5-100	<b>BCC06HK</b> BCC A325-0000-10-063-PX05A5-100
PUR	Black	15 m		

Other cable materials, colors, and lengths on request.

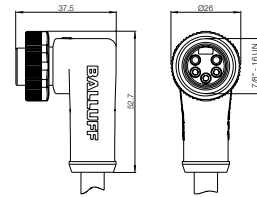

# Profibus

## Power connection cables 7/8", 5-pin



Profibus  
 Product topology  
 IO-Link modules  
 Modules  
**Power cables**  
 Power connectors  
 Power tee  
 Bus cables  
 Bus plugs  
 Bus connectors  
 Flange plug and socket  
 Terminating resistor  
 Accessories  
 Profinet  
 CC-Link  
 Devicenet  
 Ethernet/IP  
 Unmanaged switches

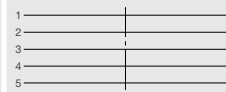
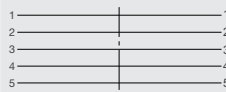
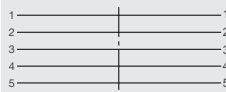
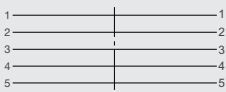
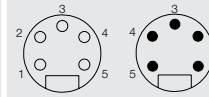
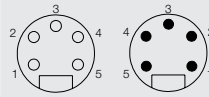
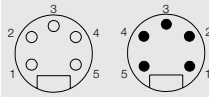
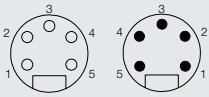

Female/male

Female/male

Female/male

Female/male

300 V DC

300 V DC

300 V DC

300 V DC

5×1.5 mm<sup>2</sup>

5×1.5 mm<sup>2</sup>

5×1.5 mm<sup>2</sup>

5×1.5 mm<sup>2</sup>

IP 68

IP 68

IP 68

IP 68

-25...+80 °C

-25...+80 °C

-25...+80 °C

-25...+80 °C

### Ordering code

Part number

**BCC06FM**

**BCC06FU**

**BCC06H1**

**BCC06H6**

BCC A315-A315-30-335-PX05A5-006

BCC A315-A325-30-335-PX05A5-006

BCC A325-A315-30-335-PX05A5-006

BCC A325-A325-30-335-PX05A5-006

**BCC06FN**

**BCC06FW**

**BCC06H2**

**BCC06H7**

BCC A315-A315-30-335-PX05A5-020

BCC A315-A325-30-335-PX05A5-020

BCC A325-A315-30-335-PX05A5-020

BCC A325-A325-30-335-PX05A5-020

**BCC06FP**

**BCC06FY**

**BCC06H3**

**BCC06H8**

BCC A315-A315-30-335-PX05A5-050

BCC A315-A325-30-335-PX05A5-050

BCC A325-A315-30-335-PX05A5-050

BCC A325-A325-30-335-PX05A5-050

**BCC06FR**

**BCC06FZ**

**BCC06H4**

**BCC06H9**

BCC A315-A315-30-335-PX05A5-100

BCC A315-A325-30-335-PX05A5-100

BCC A325-A315-30-335-PX05A5-100

BCC A325-A325-30-335-PX05A5-100

**BCC06FT**

**BCC06H0**

**BCC06H5**

**BCC06HA**

BCC A315-A315-30-335-PX05A5-150

BCC A315-A325-30-335-PX05A5-150

BCC A325-A315-30-335-PX05A5-150

BCC A325-A325-30-335-PX05A5-150

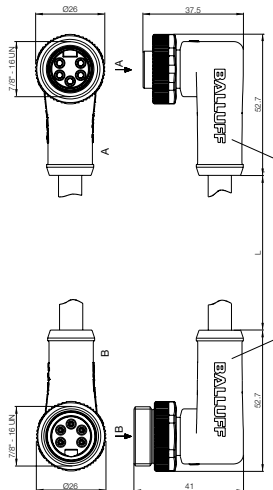
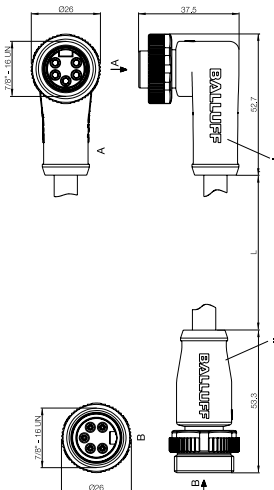
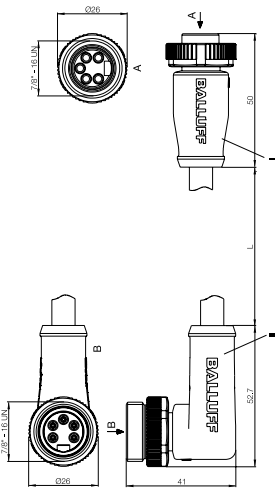
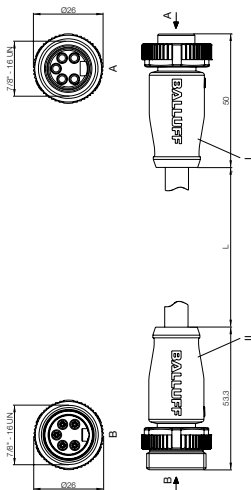



Connector diagram and wiring	<p>Shield on cap nut</p>	<p>Shield on cap nut</p>	
Type	Female	Male	Female/male
Supply voltage $U_B$	300 V	300 V	300 V
Number of conductors × conductor cross-section	2×0.64 mm <sup>2</sup>	2×0.64 mm <sup>2</sup>	2×0.64 mm <sup>2</sup>
Degree of protection as per IEC 60529	IP 67	IP 67	IP 67
Ambient temperature $T_a$	-20...+70 °C	-20...+70 °C	-20...+70 °C

Cable material	Color	Length	Ordering code			
			Part number			
PUR		Violet	0.6 m		<b>BCC0A12</b> BCC M415-M412-3B-329-PS72N1-006	
PUR		Violet	1 m		<b>BCC0A13</b> BCC M415-M412-3B-329-PS72N1-010	
PUR		Violet	2 m	<b>BCC070Y</b> BCC M415-0000-1B-031-PS72N1-020	<b>BCC0A0Y</b> BCC M412-0000-2B-031-PS72N1-020	<b>BCC0A14</b> BCC M415-M412-3B-329-PS72N1-020
PUR		Violet	5 m	<b>BCC070Z</b> BCC M415-0000-1B-031-PS72N1-050	<b>BCC0A0Z</b> BCC M412-0000-2B-031-PS72N1-050	<b>BCC0A15</b> BCC M415-M412-3B-329-PS72N1-050
PUR		Violet	10 m	<b>BCC0710</b> BCC M415-0000-1B-031-PS72N1-100	<b>BCC0A10</b> BCC M412-0000-2B-031-PS72N1-100	<b>BCC0A16</b> BCC M415-M412-3B-329-PS72N1-100
PUR		Violet	15 m		<b>BCC0A17</b> BCC M415-M412-3B-329-PS72N1-150	
PUR		Violet	20 m		<b>BCC0A18</b> BCC M415-M412-3B-329-PS72N1-200	

Other cable lengths on request.

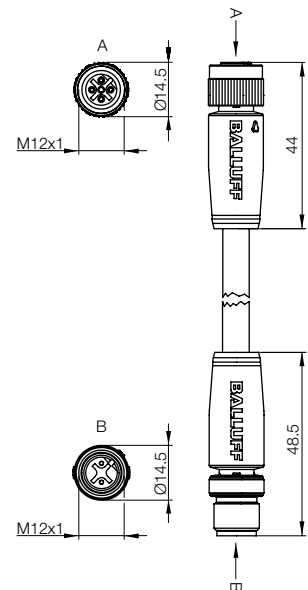
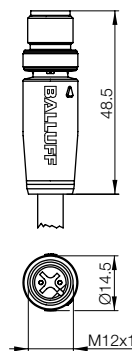
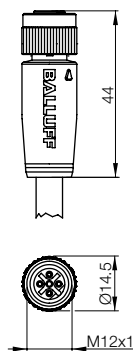



# Profibus

## Bus plug with switchable terminating resistor



Profibus  
 Product topology  
 IO-Link modules  
 Modules  
 Power cables  
 Power connectors  
 Power tee  
**Bus cables**  
**Bus plugs**  
 Bus connectors  
 Flange plug and socket  
 Terminating resistor  
 Accessories  
 Profinet  
 CC-Link  
 Devicenet  
 Ethernet/IP  
 Unmanaged switches

Connector diagram and wiring		
Type	Female/male	Female/male
Connector type	Sub D/M12	Male Sub D / female Sub D
Supply voltage $U_B$	30 V	30 V
Degree of protection as per IEC 60529	IP 67	IP 30
Ambient temperature $T_a$	-20...+70 °C	-20...+70 °C
	<b>Ordering code</b>	
	Part number	
Cable outlets, right-angle	<b>BCC0C0Y</b> BCC D259-M414-M415-U0029-000-C011	<b>BCC0C10</b> BCC D279-0000-E0-000-65X4N1-000-C011
Cable outlets, straight	<b>BCC0C0Z</b> BCC D269-M414-M415-U0029-000-C011	<b>BCC0C11</b> BCC D289-0000-E0-000-65X4N1-000-C011

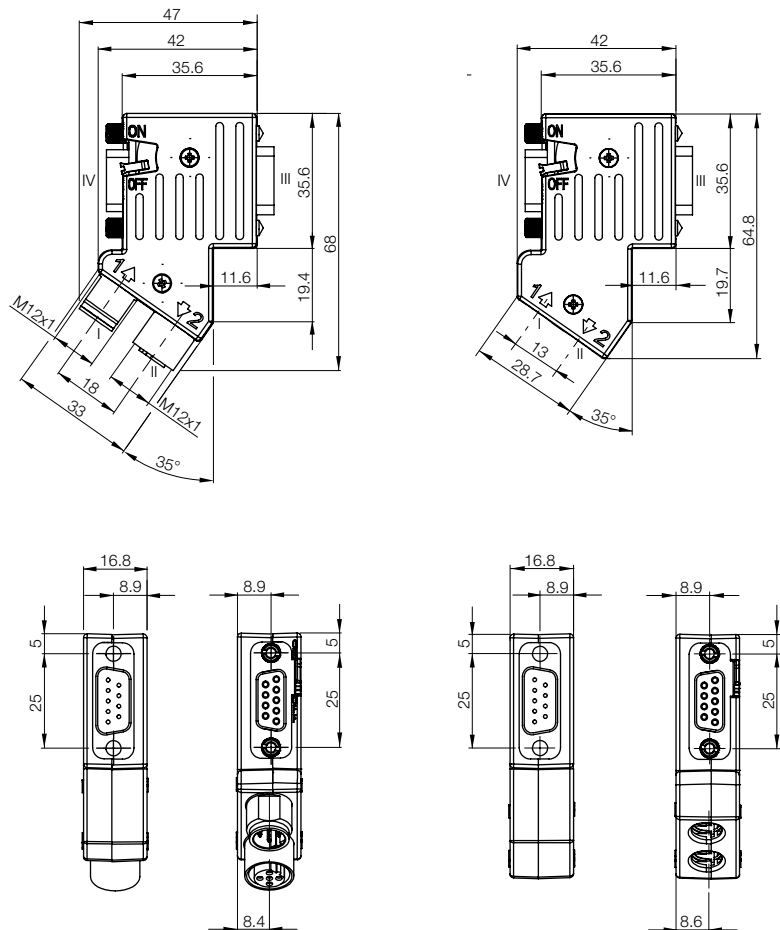

# Profibus

## Flange plug and socket



Connector diagram and wiring



1 \_\_\_\_\_  
2 \_\_\_\_\_  
3 \_\_\_\_\_  
4 \_\_\_\_\_  
5 \_\_\_\_\_



1 \_\_\_\_\_  
2 \_\_\_\_\_  
3 \_\_\_\_\_  
4 \_\_\_\_\_  
5 \_\_\_\_\_

Supply voltage  $U_B$

125 V

125 V

Number of conductors × conductor cross-section

2×0.25 mm<sup>2</sup>

2×0.25 mm<sup>2</sup>

Degree of protection as per IEC 60529

IP 68

IP 68

Ambient temperature  $T_a$

-25...+85 °C

-25...+85 °C

**Cable length**

**Ordering code**

Part number

0.2 m

**BCC0E40**

**BCC0E3Z**

BCC M452-0000-2B-RM080-002

BCC M455-0000-1B-RM080-002

Other cable lengths on request.

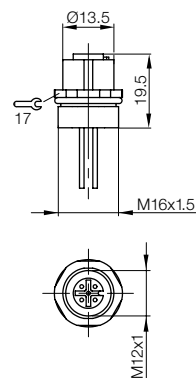
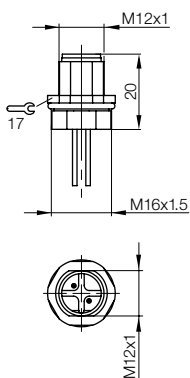



Profibus  
Product topology  
IO-Link modules  
Modules  
Power cables  
Power connectors  
Power tee  
Bus cables  
Bus plugs  
Bus connectors  
**Flange plug and socket**  
Terminating resistor  
Accessories  
Profinet  
CC-Link  
Devicenet  
Ethernet/IP  
Unmanaged switches

**Power plug connector, 7/8", 5-pin**



Connector diagram and wiring		
Type	Female	Male
Supply voltage U <sub>B</sub>	300 V	300 V
Number of conductors × conductor cross-section	5 × max. 1.5 mm <sup>2</sup>	5 × max. 1.5 mm <sup>2</sup>
Degree of protection as per IEC 60529	IP 67	IP 67
Ambient temperature T <sub>a</sub>	-25...+80 °C	-25...+80 °C

Cable material	Color	Ordering code	
Cable dia.		Part number	
PUR	Black	<b>BCC070E</b>	<b>BCC070J</b>
6...8 mm		BCC A335-0000-10-000-51X5A5-000	BCC A335-0000-20-000-51X5A5-000
PUR	Black	<b>BCC070F</b>	<b>BCC070K</b>
8...10 mm		BCC A335-0000-10-000-61X5A5-000	BCC A335-0000-20-000-61X5A5-000
PUR	Black	<b>BCC070H</b>	<b>BCC070L</b>
10...12 mm		BCC A335-0000-10-000-71X5A5-000	BCC A335-0000-20-000-71X5A5-000

Other cable diameters on request.

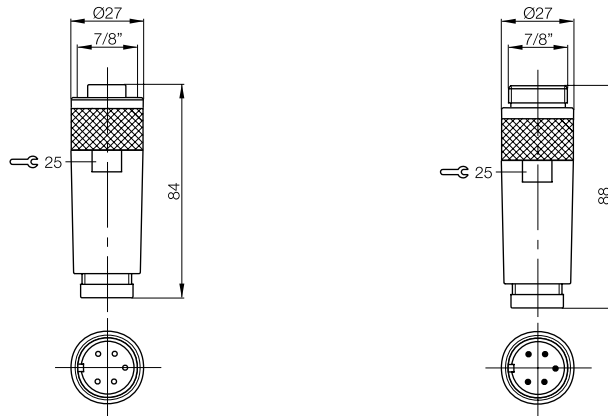

# Profibus

## Bus plug connector, M12, 5-pin, B-coded, Customized assembly, shieldable



Profibus  
Product topology  
IO-Link modules  
Modules  
Power cables  
**Power connectors**  
Power tee  
Bus cables  
Bus plugs  
**Bus connectors**  
Flange plug and socket  
Terminating resistor  
Accessories  
Profinet  
CC-Link  
Devicenet  
Ethernet/IP  
Unmanaged switches

Connector diagram and wiring				
Plug connector	M12	M12	M12	M12
Version	B-coded	B-coded	B-coded	B-coded
Type	Male	Male	Female	Female
<b>Ordering code</b>	<b>BCC0714</b>	<b>BCC0716</b>	<b>BCC0715</b>	<b>BCC0717</b>
Part number	BCC M475-0000-2B-000-01X575-000	BCC M485-0000-2B-000-01X575-000	BCC M475-0000-1B-000-01X575-000	BCC M485-0000-1B-000-01X575-000
Supply voltage $U_B$	10...30 V DC	10...30 V DC	10...30 V DC	10...30 V DC
Number of conductors × conductor cross-section	5× max. 0.75 mm <sup>2</sup>	5× max. 0.75 mm <sup>2</sup>	5× max. 0.75 mm <sup>2</sup>	5× max. 0.75 mm <sup>2</sup>
Min. cable diameter	Max. 8.0 mm	Max. 8.0 mm	Max. 8.0 mm	Max. 8.0 mm
Connection	Screw terminal	Screw terminal	Screw terminal	Screw terminal
Degree of protection as per IEC 60529	IP 67	IP 67	IP 67	IP 67
Ambient temperature $T_a$	-25...+85 °C	-25...+85 °C	-25...+85 °C	-25...+85 °C
Housing material	CuZn	CuZn	CuZn	CuZn
Shielded design	Yes	Yes	Yes	Yes

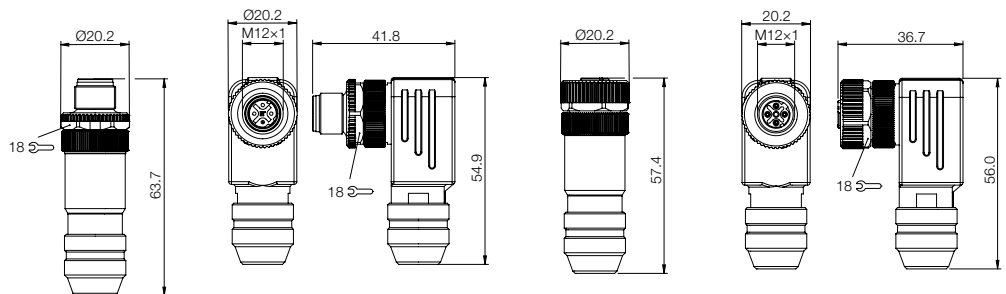



<p>Connector diagram and wiring</p>		
<p>Configuration</p>	<p>7/8" power distributor</p>	<p>M12 terminating resistor</p>
<p>Version</p>	<p>Standard, 5-pin</p>	<p>5-pin, B-coded</p>
<p>Type</p>	<p>Female/male</p>	<p>Male</p>
<p><b>Ordering code</b></p>	<p><b>BCC0AA7</b></p>	<p><b>BCC0718</b></p>
<p>Part number</p>	<p>BCC A315-A315-A315-T0023-000</p>	<p>BCC M415-0000-2B-R01</p>
<p>Supply voltage <math>U_B</math></p>	<p>300 V AC</p>	<p>10...30 V DC</p>
<p>Degree of protection as per IEC 60529</p>	<p>IP 67</p>	<p>IP 67</p>
<p>Ambient temperature <math>T_a</math></p>	<p>-40...+90 °C</p>	<p>-40...+85 °C</p>
<p>Housing material</p>	<p>Plastic</p>	<p>Plastic</p>

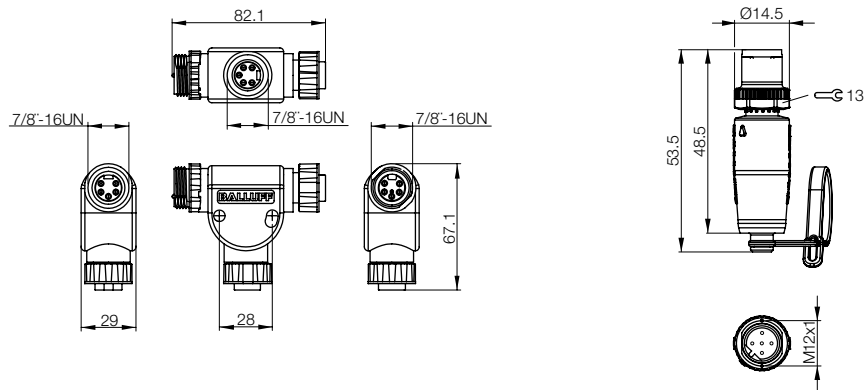



# Profibus Bus terminating resistor

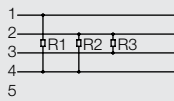
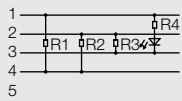

Profibus  
Product topology  
IO-Link modules  
Modules  
Power cables  
Power connectors  
**Power tee**  
Bus cables  
Bus plugs  
Bus connectors  
Flange plug and socket  
**Terminating resistor**  
Accessories  
Profinet  
CC-Link  
Devicenet  
Ethernet/IP  
Unmanaged switches

M12 terminating resistor  
5-pin, B-coded  
Male

**BCC0719**  
BCC M415-0000-2B-R02

10...30 V DC  
IP 67  
-40...+85 °C  
Plastic

M12 terminating resistor  
5-pin, B-coded  
Female

**BCC0C6E**  
BCC M415-0000-1B-R01

10...30 V DC  
IP 67  
-40...+85 °C  
Plastic

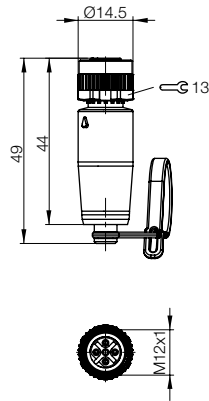
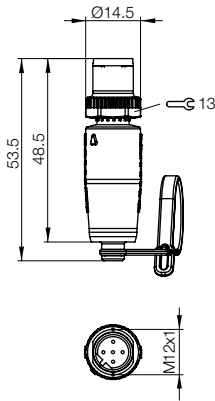



Connector diagram and wiring			
Description	T splitter	Screw plug 7/8"	Screw plug 7/8"
Use	2x M12 female to 1x M12 male	Cover for the power ports	Cover for the power ports
<b>Ordering code</b>	<b>BCC089P</b>	<b>BAM012T</b>	<b>BAM012U</b>
Part number	BCC M415-M415-M415-U0003-000	BKS-7/8-CS-00-A	BKS-7/8-CS-00-I
Supply voltage $U_b$	125 V		
Rated operating current $I_o$	4 A		
Degree of protection as per IEC 60529	IP 67		
Ambient temperature $T_a$	-25...+80 °C	-20...+80 °C	-20...+80 °C
Housing material	PA 6.6 + GF	Nickel-plated CuZn	Nickel-plated CuZn

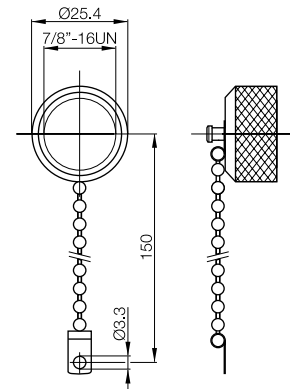
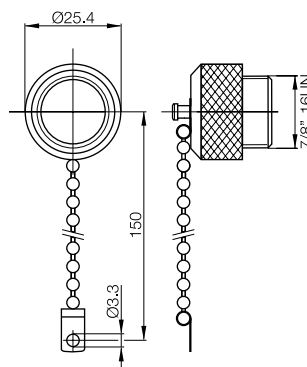
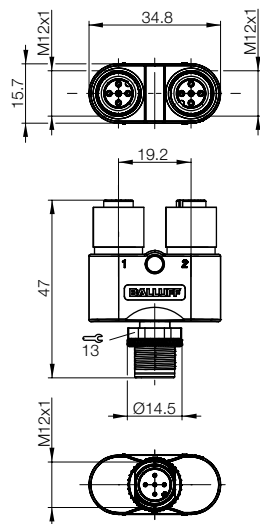

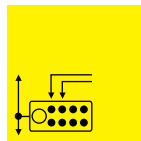

Profibus  
Product topology  
IO-Link modules  
Modules  
Power cables  
Power connectors  
Power tee  
Bus cables  
Bus plugs  
Bus connectors  
Flange plug and socket  
Terminating resistor  
**Accessories**  
Profinet  
CC-Link  
Devicenet  
Ethernet/IP  
Unmanaged switches

Description	Screw plug M12	Tamperproof cover	Marking sleeve	Label set
Use	IP 65 screw plug for unused ports	with 4 openings	For labeling connectors	Labeling the ports for modules BNI PBS..., BNI PNT..., BNI DNT..., BNI EIP..., BNI CCL...
<b>Ordering code</b>	<b>BAM01C2</b>	<b>BAM01J0</b>		<b>BAM01AT</b>
Part number	BAM CS-XA-002-M12-A	BAM FK-NI-PBS-01-C	BAM IA-CC-002-01	BNI ACC-L01-000
Ambient temperature T <sub>a</sub>	-20...+80 °C			
Housing material	Plastic			Plastic

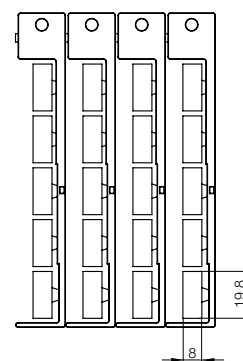
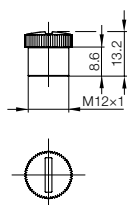

3-wire connector BCC; see the chapter "Connectors and Cables" beginning on **page 270**.



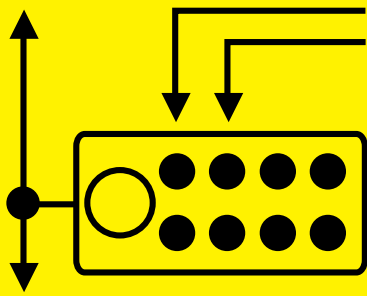

# Fieldbus Systems

## Fieldbus System: Profinet

With Profinet, industrial automation has made a significant advancement. Profinet operates on an Ethernet basis and is considerably faster than Profibus. Other advantages: Profinet can be fully integrated from the control level to the drive. Even in harsh environments. With Profinet, you also directly link drives and safety technology to the network environment.

You can also combine Profinet with Profibus with no additional work. Connecting is also extremely simple with IO-Link. This ensures freedom of installation and guarantees simplified wiring, integrated diagnostics and central configuration. Time savings and tangible cost benefits included. Thus, you help to ensure improved process quality through connectivity.



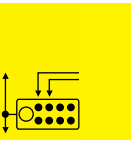

Product topology	42
IO-Link modules	46
Modules	47
Power cables	48
Power connectors	56
Power tee	57
Bus couplings	50
Bus cables	52
Bus connectors	54
Accessories	58

**Trunk and drop**

- Very simple troubleshooting
- A single device can be disconnected without disrupting the network
- Extra cable requirements result in higher costs

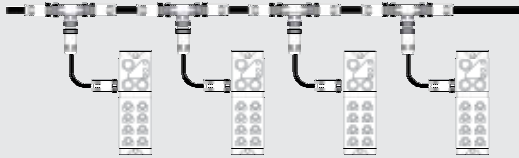

**Connected in series**

- Difficult troubleshooting
- Disconnecting a device interrupts the network
- Lower costs due to fewer cabling components

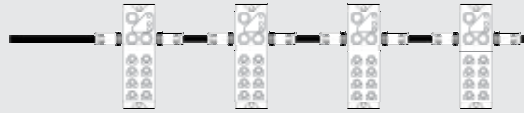

**Star**

- Simple troubleshooting
- Ideal for large I/O clusters
- Less expensive – only one splitter box needed

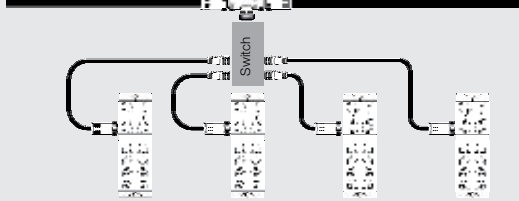

**Mixed topology**

- Creation of logical groups results in relatively simple troubleshooting
- Popular method – ideal cost/benefit ratio

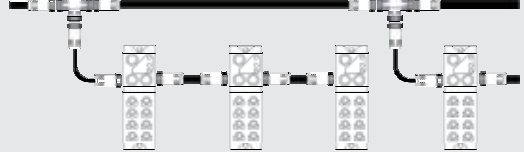

**Clearly visible status LEDs**

Low-quality LEDs that are often difficult to identify under demanding production conditions perform poorly when used in high-speed applications. Unlike Balluff status LEDs, which are large, bright, highly visible and provide maximum assistance. Balluff quality will help you complete setup and maintenance tasks and reduce machine downtimes with ease.



**Powerful and safe outputs**

With an output current of up to **2 amps**, Balluff output modules are capable of driving almost any load. Each output also offers an overload protection with LED indicator and a memory feature for easy troubleshooting.

**Robust, full-metal housing**

The fully encapsulated housing can withstand impacts, shaking, corrosive fluids, as well as people stepping on it and costs the same as a plastic housing.

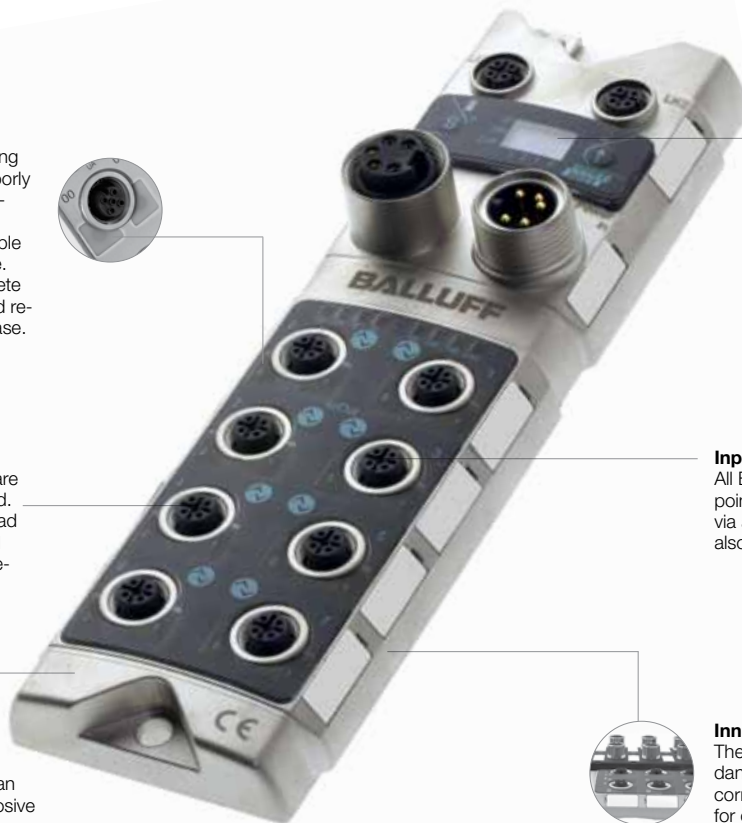

**Display**

A firmly entrenched part of the module is a display that can be locked via the PLC, which prevents unauthorized access. Two LEDs controlled by the PLC allow you to visualize results that are not specific to the module or port at the location where they occur.

**Inputs with high density**

All Balluff input blocks offer two input points for each connector, accessed via a V splitter. A DESINA output is also optionally available via pin 2.

**Innovative housing design**

The extra-flat profile reduces potential dangers posed by cables. Rounded corners offer highly visible locations for channel markers and two mounting points are sufficient to secure the robust metal housing.



High-quality connectors and compatible accessories are required to create an efficient Profinet system. Balluff offers all the components you need for constructing and supporting a first-class Profinet network.

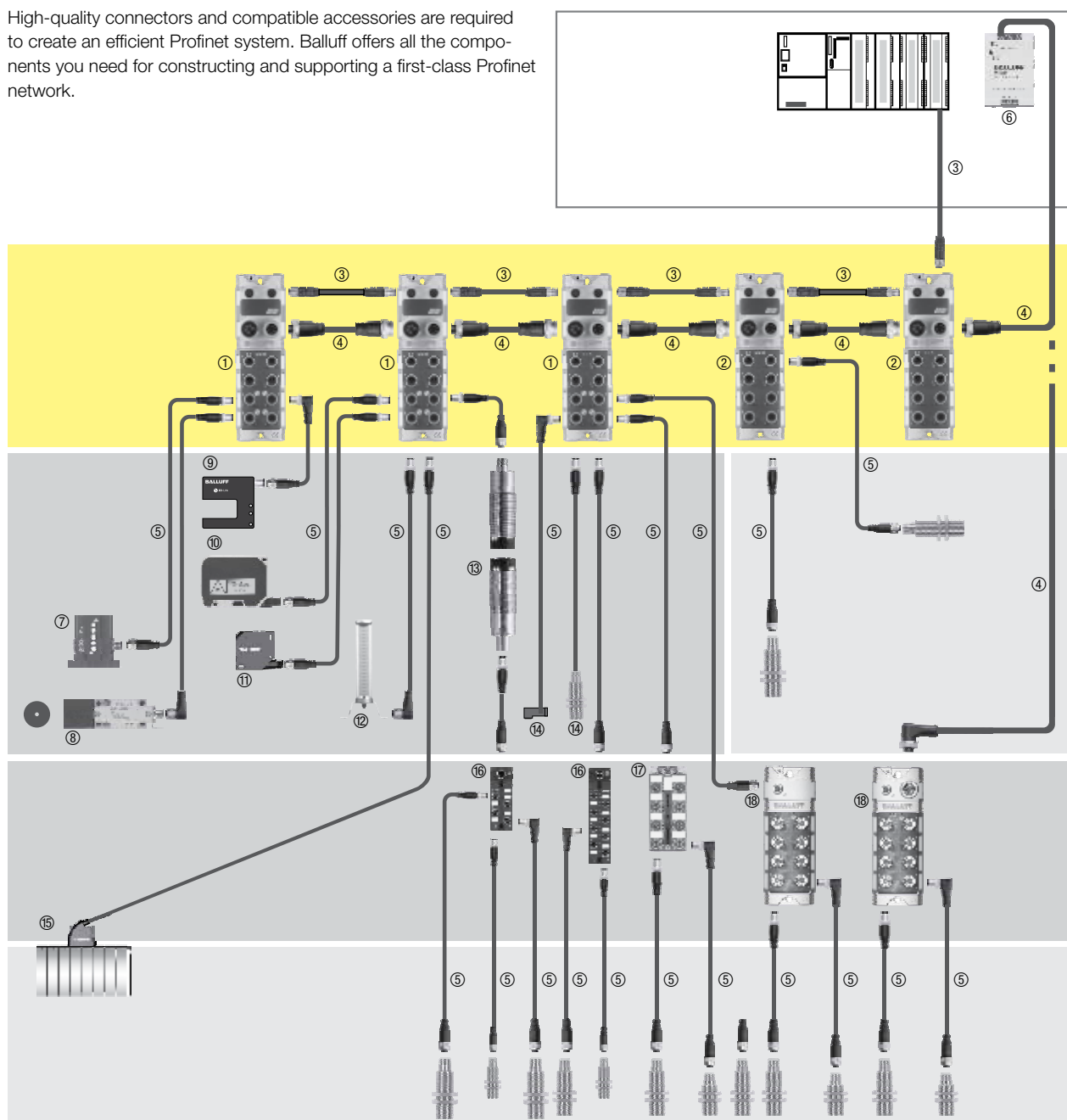

- Profibus
- Profinet
- Product topology**
- IO-Link modules
- Modules
- Power cables
- Power connectors
- Power tee
- Bus couplings
- Bus cables
- Bus connectors
- Accessories
- CC-Link
- Devicenet
- Ethernet/IP
- Unmanaged switches

- ① Profinet IO-Link module BNI
- ② Profibus module BNI
- ③ Bus cable BCC
- ④ Power cable BCC
- ⑤ Connection cable BCC
- ⑥ Power supplies BAE

- Page 46
- Page 47
- Page 52
- Page 48
- Page 336
- Page 365

## IO-Link

- ⑦ IO-Link multiple-position switch BNS
  - ⑧ IO-Link RFID system BIS
  - ⑨ IO-Link fork sensor BGL
  - ⑩ IO-Link laser distance sensor BOD
  - ⑪ IO-Link color sensor BFS
  - ⑫ IO-Link SmartLight BNI
  - ⑬ IO-Link inductive couplers BIC
  - ⑭ IO-Link inductive distance sensor BAW
  - ⑮ IO-Link valve terminal connector BNI
  - ⑯ IO-Link sensor hub BNI M8
  - ⑰ IO-Link sensor hub BNI M12
  - ⑱ Metal IO-Link sensor hub
- Page 171
  - Page 164
  - Page 157
  - Page 159
  - Page 158
  - Page 187
  - Page 210
  - Page 160
  - Page 180
  - Page 140
  - Page 145
  - Page 146

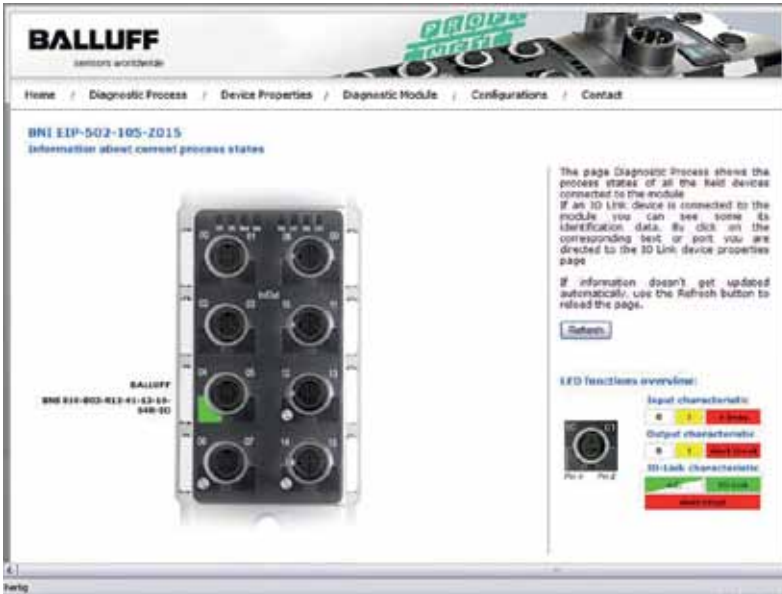

**Webserver**

For anyone that prefers a web interface, the Profinet modules from Balluff have an easily integrated webserver. This web page can be used to program the module addresses and configure several of the user-defined functions.



A simple browser provides immediate access to the integrated webserver, which has been implemented in all Profinet modules.

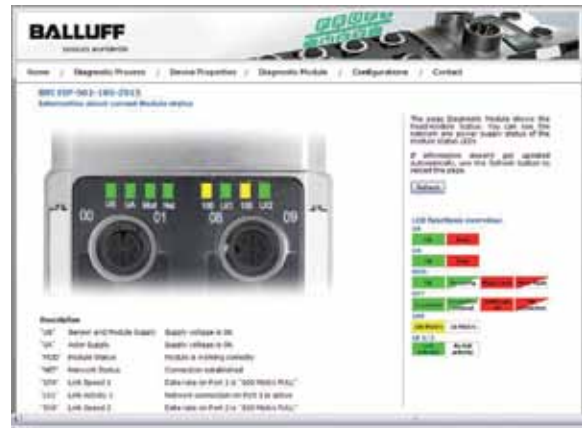

Extensive diagnostics functions are available here, such as displaying all module LEDs, including all representations in plain text.



In the "Device Properties" area you have the option, for example, of configuring devices connected to the IO-Link port.



The module configuration, such as assigning or displaying the IP address, is concealed behind the "Configurations" function.

# Profinet

## Profinet fieldbus module with eight IO-Link ports

### 136 IOs on a module

#### Balluff IO-Link solutions save cash money

Previously, at least nine fieldbus modules had to be used for the capability to activate 136 IOs. Today, a single Profinet module is sufficient.

In connection with the extremely cost-effective sensor/actuator hubs from Balluff, now up to 136 IO signals are offered which can be processed in a most efficient manner. In this way, compared to the stan-

ard fieldbus modules, there is a high cost savings of 15 to 20% per input. If you add the savings from the fieldbus and power cables to that, you get 30 to 40%. A cost-effective M12 standard cable BCC is sufficient to switch on a sensor/actuator hub. Furthermore, sensor hubs need just one bus address, can variably group sensor signals together within an area of 20 m and ensure exceptional efficiency.

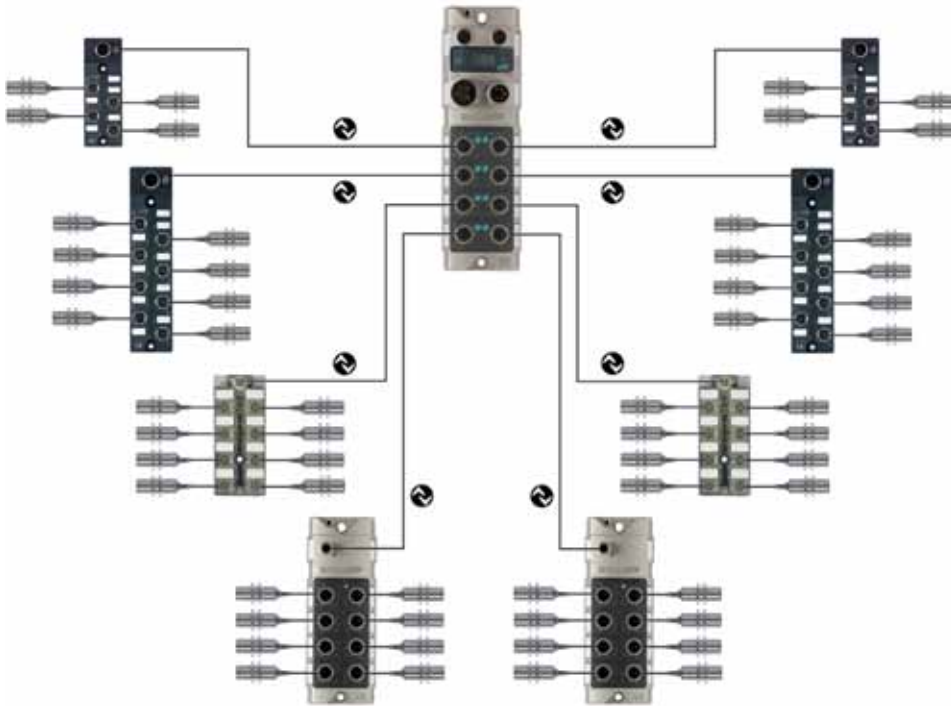

### 1000 tasks, one module:

#### The Profinet module with eight IO-Link ports

Whether position measurement, object detection, identification, fluid sensor applications, temperature or pressure measurement, through IO-Link, the Profinet module is suitable for every job.

IO-Link not only has advantages for installing standard sensors, but also can integrate intelligent devices via the same interface. With that, the module provides a uniform interface from the signal to the control level.

During field installation of intelligent devices, there are frequently high costs, as shielded cable and intelligent interface cards such as analog input cards are used in the controller. IO-Link not only makes error-prone analog inputs superfluous, it also reduces the wiring, inspection and hardware effort. With simple plug-and-play of unshielded, cost-effective M12 lines, the system is quickly and securely brought into operation.

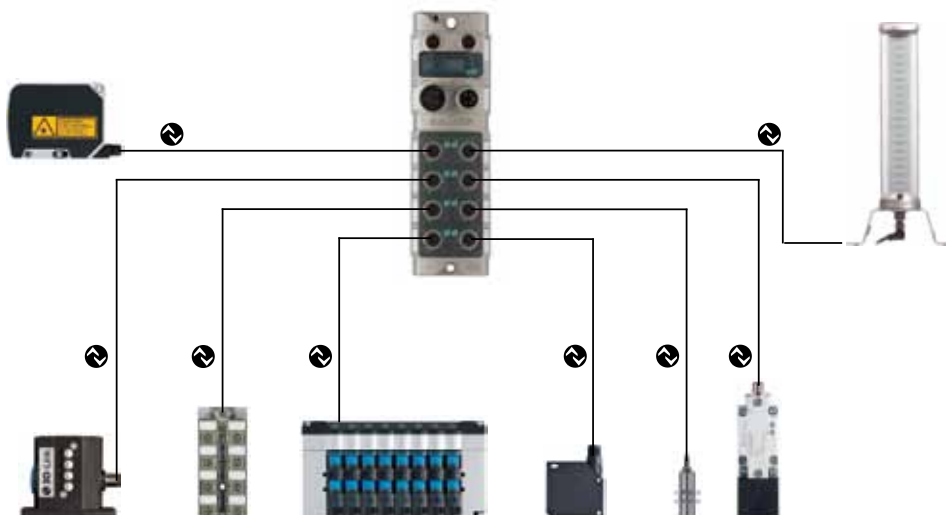

- Profibus
- Profinet
- Product topology
- IO-Link modules
- Modules
- Power cables
- Power connectors
- Power tee
- Bus couplings
- Bus cables
- Bus connectors
- Accessories
- CC-Link
- Devicenet
- Ethernet/IP
- Unmanaged switches

# Profinet IO-Link modules

## Second generation with display, integrated switch and web server

For high-performance applications, consider the Profinet IO-Link master interface, which also supports isochronal realtime (IRT) using ERTEC 200.

The module includes four IO-Link master ports that can be configured and used fully independently of one another. All IO-Link ports support COM1, COM2, COM3 (3-wire only) as well as SIO mode.

The IO-Link ports also have an additional input or input/output via pin 2. This means that SIO mode also enables the connection of complementary NO/NC and DESINA sensors.

You get four additional standard IO ports with eight inputs or eight freely configurable inputs/outputs for standard sensors and actuators up to 2 A.

Profinet is increasingly becoming the communications medium of the future for mechanical and plant engineering. In some areas, it has already incrementally replaced the Profibus. Based on Ethernet, communication over Profinet is significantly faster, and the volume of data is significantly higher than with classic fieldbus systems and allows the connection of time-critical drive technology. Furthermore, Profinet is quick to install and integrates easily into existing networks. In addition to time savings and considerable cost savings comes the added benefit of ease of operation. This is because only Balluff provides Profinet modules with a display that allows IP addresses to be blocked, protecting the modules from accidental changes. This increases security and simplifies maintenance.

Naturally, even in the second generation of Profinet modules, IO-Link is a firmly entrenched part. The Profinet module with IO-Link functionality has four or eight IO-Link master ports, which the user can configure and use completely independently of one another. You get four additional, freely configurable standard-I/O ports, which make an additional eight inputs/outputs available for standard sensors and actuators.

As a new feature, the second generation of Profinet provides an integrated 2-port Ethernet switch that makes it possible to install a linear topology in the system without an additional external switch.

Also new in this generation is the integrated webserver.



Fieldbus	Profinet
Version	8x IO-Link, 16x DI/DO
<b>Ordering code</b>	<b>BNI005H</b>
Part number	BNI PNT-508-105-Z015
Supply voltage $U_B$	18...30 V DC
Function indicator	BUS/RUN
Indicators/input	Display/pushbutton
Module status indicator: Mod LED	Yes
Network status indicator: Net LED	Yes
Port status indicator	Black, red, yellow
Connection: Fieldbus	M12, D-coded, female
Connection: AUX power	7/8", male, 5-pin
Connection: I/O ports	M12, A-coded, female
No. of I/O ports	8
Number of inputs	max. 16 PNP
Number of outputs	max. 16 PNP
Configurable inputs/outputs	Yes
Max. load current, sensors/channel	200 mA
Max. load current, output	1.2 A/2 A
Port status indicator (signal status)	Yellow LED
Port diagnostic indicator (overload)	Red LED
Total current $U_{Actuator}$	≤ 9 A
Total current $U_{Sensor}$	≤ 9 A
Degree of protection as per IEC 60529	IP 67 (when screwed into place)
Operating temperature $T_a$	-5...+70 °C
Storage temperature	-25...+70 °C
Fastener	2 mounting holes
Dimensions (L×W×H)	225×68×36.9 mm
Housing material	Nickel-plated GdZn

### IO-Link Version 1.1

No. of IO-Link master ports	8x master
Operating modes (3-wire)	SIO, COM 1, COM 2, COM 3
Indicators	Communication: Green LED Error: Red LED
Max. load current for IO-Link device	1.2 A

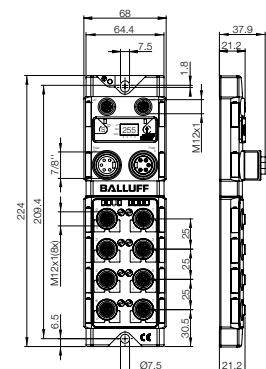

All modules include four screw plugs and a label set.



Profibus  
Profinet  
Product topology  
**IO-Link modules**  
**Modules**  
Power cables  
Power connectors  
Power tee  
Bus couplings  
Bus cables  
Bus connectors  
Accessories  
CC-Link  
Devicenet  
Ethernet/IP  
Unmanaged switches



IO-Link

	Profinet	Profinet	Profinet	Profinet	Profinet
	4x IO-Link, 16x DI/DO	16x DI/DO, configurable	16 DI	8 DO	8 DI/8 DO
	<b>BNI004U</b>	<b>BNI0052</b>	<b>BNI0053</b>	<b>BNI005F</b>	<b>BNI005K</b>
	BNI PNT-502-105-Z015	BNI PNT-302-105-Z015	BNI PNT-104-105-Z015	BNI PNT-202-105-Z015	BNI PNT-305-105-Z015
	18...30 V DC	18...30 V DC	18...30 V DC	18...30 V DC	18...30 V DC
	BUS/RUN	BUS/RUN	BUS/RUN	BUS/RUN	BUS/RUN
	Display/pushbutton	Display/pushbutton	Display/pushbutton	Display/pushbutton	Display/pushbutton
	Yes	Yes	Yes	Yes	Yes
	Yes	Yes	Yes	Yes	Yes
	Black, red, yellow	Black, red, yellow	Black, red, yellow	Black, red, yellow	Black, red, yellow
	M12, D-coded, female	M12, D-coded, female	M12, D-coded, female	M12, D-coded, female	M12, D-coded, female
	7/8", male, 5-pin	7/8", male, 5-pin	7/8", male, 5-pin	7/8", male, 5-pin	7/8", male, 5-pin
	M12, A-coded, female	M12, A-coded, female	M12, A-coded, female	M12, A-coded, female	M12, A-coded, female
	8	8	8	8	8
	max. 16 PNP	max. 16 PNP	16 PNP	8 PNP	8 PNP
	max. 16 PNP	max. 16 PNP		No	No
	Yes	Yes	No	No	No
	200 mA	200 mA	200 mA		200 mA
	1.6 A/2 A	2 A		2 A	2 A
	Yellow LED	Yellow LED	Yellow LED	Yellow LED	Yellow LED
	Red LED	Red LED	Red LED	Red LED	Red LED
	≤ 9 A	≤ 9 A	≤ 9 A	≤ 9 A	≤ 9 A
	≤ 9 A	≤ 9 A	≤ 9 A	≤ 9 A	≤ 9 A
	IP 67 (when screwed into place)	IP 67 (when screwed into place)	IP 67 (when screwed into place)	IP 67 (when screwed into place)	IP 67 (when screwed into place)
	-5...+70 °C	-5...+70 °C	-5...+70 °C	-5...+70 °C	-5...+70 °C
	-25...+70 °C	-25...+70 °C	-25...+70 °C	-25...+70 °C	-25...+70 °C
	2 mounting holes	2 mounting holes	2 mounting holes	2 mounting holes	2 mounting holes
	225x68x36.9 mm	225x68x36.9 mm	225x68x36.9 mm	175x68x36.9 mm	300x68x36.9 mm
	Nickel-plated GdZn	Nickel-plated GdZn	Nickel-plated GdZn	Nickel-plated GdZn	Nickel-plated GdZn

	4x master
	SIO, COM 1, COM 2, COM 3
	Green LED
	Red LED
	1.6 A

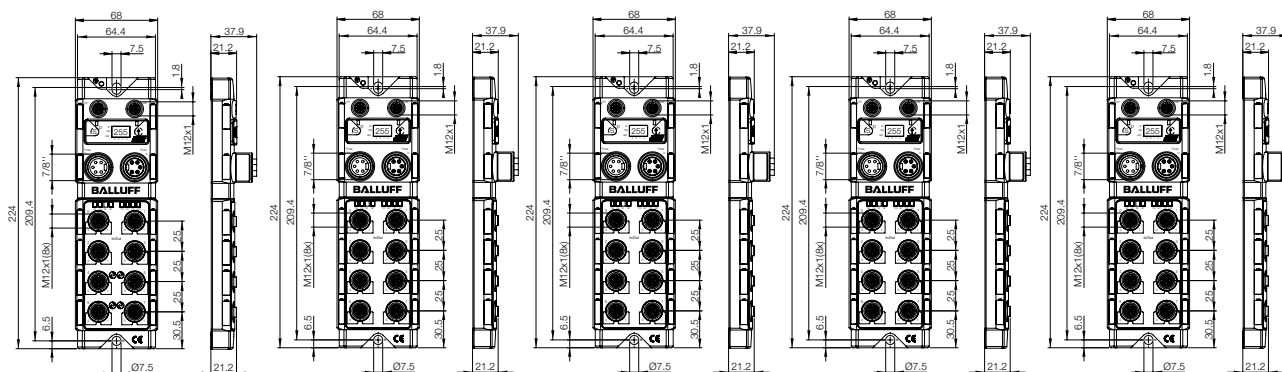

Profinet  
Power cables 7/8", 5-pin



Connector diagram and wiring

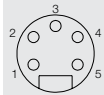

PIN 1: black  
PIN 2: blue  
PIN 3: green/yellow  
PIN 4: brown  
PIN 5: white

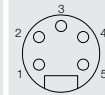

PIN 1: black  
PIN 2: blue  
PIN 3: green/yellow  
PIN 4: brown  
PIN 5: white



Type	Female	Female
Supply voltage $U_b$	300 V DC	300 V DC
Number of conductors × conductor cross-section	5×1.5 mm <sup>2</sup>	5×1.5 mm <sup>2</sup>
Degree of protection as per IEC 60529	IP 68	IP 68
Ambient temperature $T_a$	-25...+80 °C	-25...+80 °C

Cable material	Color	Length	Ordering code	
			Part number	
PUR	Black	0.6 m		
PUR	Black	2 m	<b>BCC06HC</b> BCC A315-0000-10-063-PX05A5-020	<b>BCC06HH</b> BCC A325-0000-10-063-PX05A5-020
PUR	Black	5 m	<b>BCC06HE</b> BCC A315-0000-10-063-PX05A5-050	<b>BCC06HJ</b> BCC A325-0000-10-063-PX05A5-050
PUR	Black	10 m	<b>BCC06HF</b> BCC A315-0000-10-063-PX05A5-100	<b>BCC06HK</b> BCC A325-0000-10-063-PX05A5-100
PUR	Black	15 m		

Other cable materials, colors, and lengths on request.

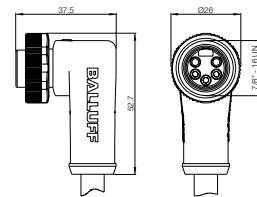



# Profinet

## Power connection cables 7/8", 5-pin



Profibus  
 Profinet  
 Product topology  
 IO-Link modules  
 Modules  
**Power cables**  
 Power connectors  
 Power tee  
 Bus couplings  
 Bus cables  
 Bus connectors  
 Accessories  
 CC-Link  
 Devicenet  
 Ethernet/IP  
 Unmanaged switches

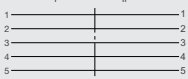
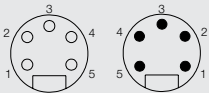

Female/male  
 300 V DC  
 5x1.5 mm<sup>2</sup>  
 IP 68  
 -25...+80 °C

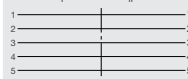
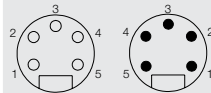

Female/male  
 300 V DC  
 5x1.5 mm<sup>2</sup>  
 IP 68  
 -25...+80 °C

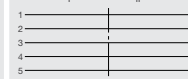
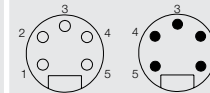

Female/male  
 300 V DC  
 5x1.5 mm<sup>2</sup>  
 IP 68  
 -25...+80 °C

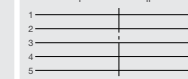
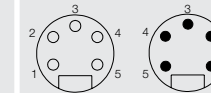

Female/male  
 300 V DC  
 5x1.5 mm<sup>2</sup>  
 IP 68  
 -25...+80 °C

### Ordering code

Part number

BCC06FM	BCC06FU	BCC06H1	BCC06H6
BCC A315-A315-30-335-PX05A5-006	BCC A315-A325-30-335-PX05A5-006	BCC A325-A315-30-335-PX05A5-006	BCC A325-A325-30-335-PX05A5-006
BCC06FN	BCC06FW	BCC06H2	BCC06H7
BCC A315-A315-30-335-PX05A5-020	BCC A315-A325-30-335-PX05A5-020	BCC A325-A315-30-335-PX05A5-020	BCC A325-A325-30-335-PX05A5-020
BCC06FP	BCC06FY	BCC06H3	BCC06H8
BCC A315-A315-30-335-PX05A5-050	BCC A315-A325-30-335-PX05A5-050	BCC A325-A315-30-335-PX05A5-050	BCC A325-A325-30-335-PX05A5-050
BCC06FR	BCC06FZ	BCC06H4	BCC06H9
BCC A315-A315-30-335-PX05A5-100	BCC A315-A325-30-335-PX05A5-100	BCC A325-A315-30-335-PX05A5-100	BCC A325-A325-30-335-PX05A5-100
BCC06FT	BCC06H0	BCC06H5	BCC06HA
BCC A315-A315-30-335-PX05A5-150	BCC A315-A325-30-335-PX05A5-150	BCC A325-A315-30-335-PX05A5-150	BCC A325-A325-30-335-PX05A5-150

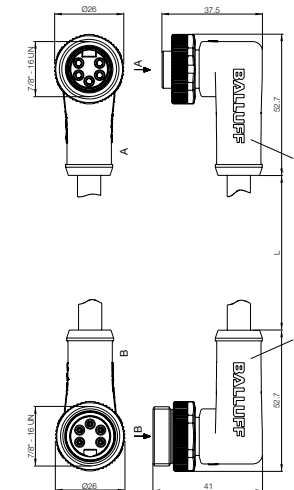
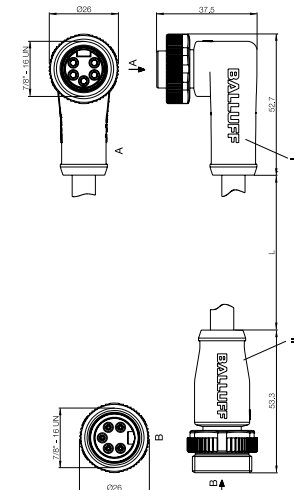
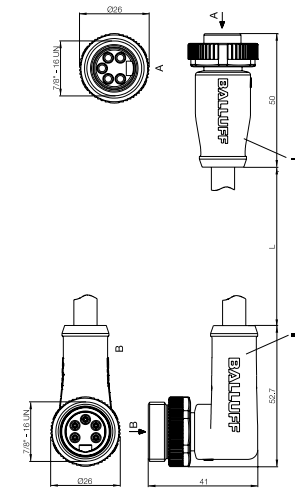
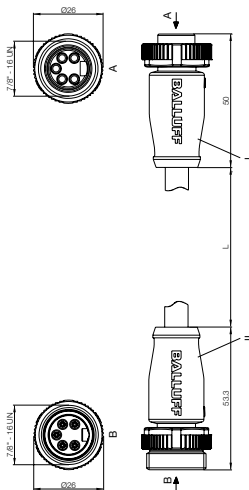



Connector diagram and wiring		
Type	M12 female straight/RJ45 straight, pass-thru	M12 female straight/RJ45 right angle, pass-thru
Coding	D-coded/no coding	D-coded/no coding
Supply voltage $U_b$	60 V AC/DC	60 V AC/DC
Degree of protection	IP 20	IP 20
Ambient temperature $T_a$	-25...+85 °C	-25...+85 °C
Mounting thread	M16	M16

	<b>Ordering code</b>	
	Part number	
	<b>BCC085F</b>	<b>BCC085H</b>
	BCC M414-E814-BG-RM013-000	BCC M424-E814-BG-RM013-000

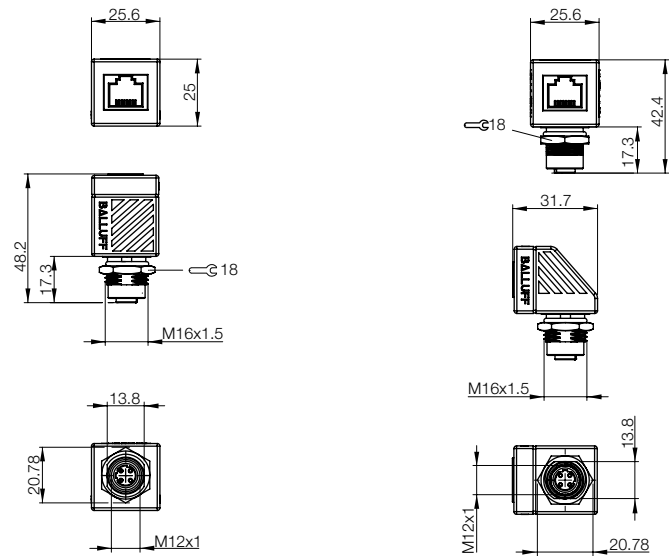



# Profinet

## Bus couplings and pass-thrus



Profibus  
 Profinet  
 Product topology  
 IO-Link modules  
 Modules  
 Power cables  
 Power connectors  
 Power tee  
**Bus couplings**  
 Bus cables  
 Bus connectors  
 Accessories  
 CC-Link  
 Devicenet  
 Ethernet/IP  
 Unmanaged switches

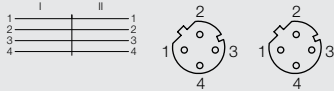

M12 female straight/M12 female straight,  
 pass-thru  
 D-coded  
 60 V AC/DC  
 IP 67  
 -25...+80 °C  
 M16

### Ordering code

Part number

**BCC06YP**

BCC M454-M454-5D-RM002-000

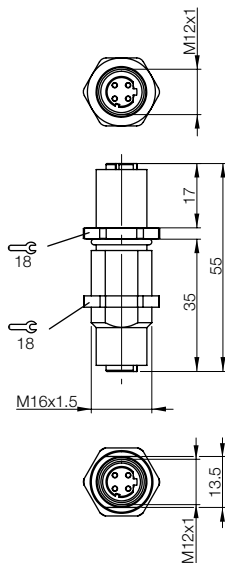

**Bus connection cables M12, 4-pin, D-coded**



Connector diagram and wiring

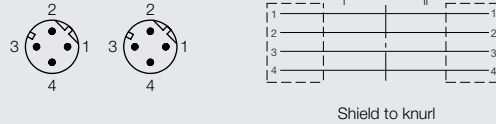

Type	M12 male straight/M12 male straight
Supply voltage $U_b$	60 V AC/DC
Number of conductors × conductor cross-section	4×22 AWG
Degree of protection as per IEC 60529	IP 68
Ambient temperature $T_a$	-20...+60 °C

Cable material	Color	Length	Ordering code
PUR shielded	Green	0.6 m	<b>BCC04K0</b> Part number BCC M414-M414-6D-331-PS54T2-006
PUR shielded	Green	2 m	<b>BCC04K1</b> BCC M414-M414-6D-331-PS54T2-020
PUR shielded	Green	5 m	<b>BCC04K2</b> BCC M414-M414-6D-331-PS54T2-050
PUR shielded	Green	10 m	<b>BCC04K3</b> BCC M414-M414-6D-331-PS54T2-100
PUR shielded	Green	15 m	<b>BCC04ZH</b> BCC M414-M414-6D-331-PS54T2-150
PUR shielded	Green	20 m	<b>BCC04K4</b> BCC M414-M414-6D-331-PS54T2-200
PUR shielded	Green	30 m	<b>BCC04K5</b> BCC M414-M414-6D-331-PS54T2-300

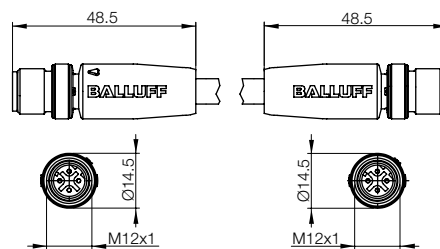

# Profinet

## Bus connection cables M12, 4-pin, D-coded and RJ45



Profibus  
 Profinet  
 Product topology  
 IO-Link modules  
 Modules  
 Power cables  
 Power connectors  
 Power tee  
 Bus couplings  
**Bus cables**  
 Bus connectors  
 Accessories  
 CC-Link  
 Devicenet  
 Ethernet/IP  
 Unmanaged switches

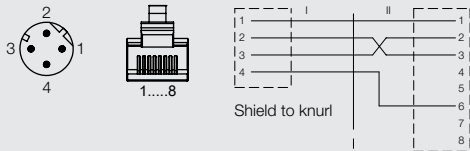

M12 male straight/RJ45 male straight  
 60 V AC/DC  
 4×22 AWG  
 IP 68/IP 20  
 -20...+60 °C

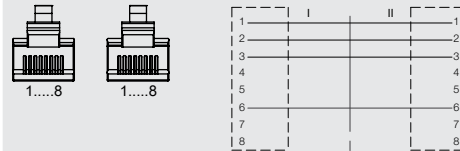

RJ45 male straight/RJ45 male straight  
 60 V AC/DC  
 4×22 AWG  
 IP 20  
 -20...+60 °C

Ordering code	
Part number	
<b>BCC04K6</b>	<b>BCC04KE</b>
BCC M414-E834-8G-668-PS54T2-006	BCC E834-E834-90-334-PS54T2-006
<b>BCC04K7</b>	<b>BCC04KF</b>
BCC M414-E834-8G-668-PS54T2-020	BCC E834-E834-90-334-PS54T2-020
<b>BCC04K8</b>	<b>BCC04KH</b>
BCC M414-E834-8G-668-PS54T2-050	BCC E834-E834-90-334-PS54T2-050
<b>BCC04K9</b>	<b>BCC04KJ</b>
BCC M414-E834-8G-668-PS54T2-100	BCC E834-E834-90-334-PS54T2-100
<b>BCC04ZJ</b>	<b>BCC04ZK</b>
BCC M414-E834-8G-668-PS54T2-150	BCC E834-E834-90-334-PS54T2-150
<b>BCC04KA</b>	<b>BCC04KK</b>
BCC M414-E834-8G-668-PS54T2-200	BCC E834-E834-90-334-PS54T2-200
<b>BCC04KC</b>	<b>BCC04KL</b>
BCC M414-E834-8G-668-PS54T2-300	BCC E834-E834-90-334-PS54T2-300

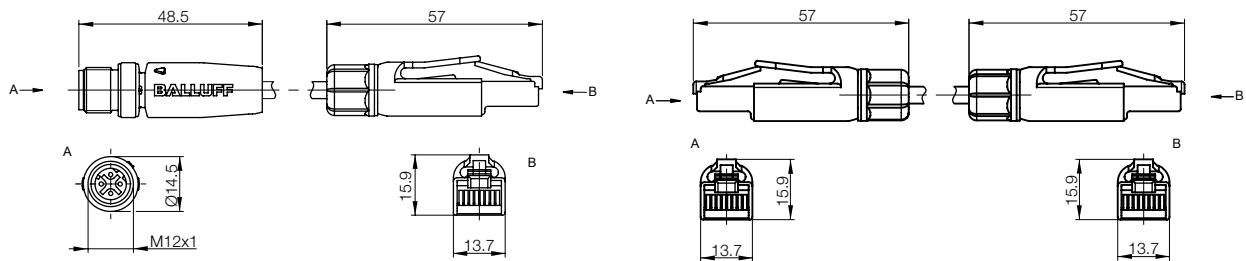

**Bus connector M12, 4-pin, D-coded,  
User-fabricated, shieldable**



Connector diagram and wiring			
Connector	M12 male, straight	M12 male, right-angle	
Version	4-pin, D-coded	4-pin, D-coded	
<b>Ordering code</b>	<b>BCC03WZ</b>	<b>BCC03Y0</b>	
Part number	BCC M474-0000-2D-000-51X475-000	BCC M484-0000-2D-000-51X475-000	
Nominal voltage	60 V AC/DC	60 V AC/DC	
Number of connections	4	4	
Number of conductors x Cross-section	4x0.75 mm <sup>2</sup>	4x0.75 mm <sup>2</sup>	
Cable diameter	Max. 8 mm	Max. 8 mm	
Connection	Cage clamp	Screw plug	
Degree of protection as per IEC 60529	IP 67	IP 67	
Ambient temperature T <sub>a</sub>	-25...+85 °C	-25...+85 °C	
Housing material	CuZn	CuZn	
Shielded design	Yes	Yes	

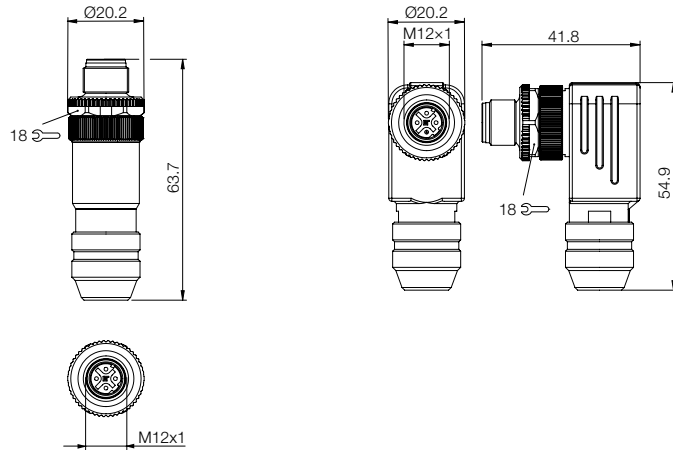

Profinet

**Bus connector M12, 4-pin, D-coded, User-fabricated, shieldable**



Profibus  
Profinet  
Product topology  
IO-Link modules  
Modules  
Power cables  
Power connectors  
Power tee  
Bus couplings  
Bus cables  
**Bus connectors**  
Accessories  
CC-Link  
Devicenet  
Ethernet/IP  
Unmanaged switches

M12 female, straight 4-pin, D-coded	M12 female, right-angle 4-pin, D-coded	RJ45 male, straight No coding
<b>BCC03Y1</b>	<b>BCC03Y2</b>	<b>BCC06FH</b>
BCC M474-0000-1D-000-51X475-000	BCC M484-0000-1D-000-51X475-000	BCC E834-0000-20-000-53X4T2-000
60 V AC/DC	60 V AC/DC	60 V AC/DC
4	4	8
4x0.75 mm <sup>2</sup>	4x0.75 mm <sup>2</sup>	244x max. AWG 22
Max. 8 mm	Max. 8 mm	Max. 9 mm
Cage clamp	Screw plug	Insulation displacement connector technology
IP 67	IP 67	IP 20
-25...+85 °C	-25...+85 °C	-40...+70 °C
CuZn	CuZn	
Yes	Yes	Yes

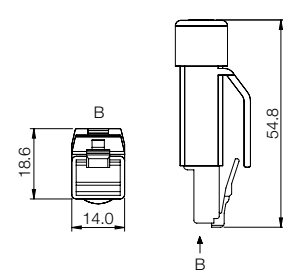
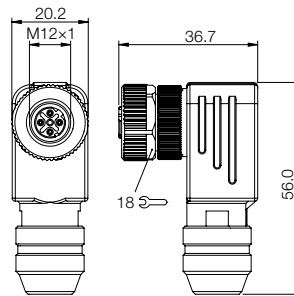
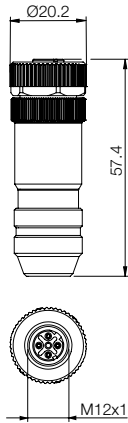

**Power plug connector, 7/8", 5-pin**



Connector diagram and wiring		
Type	Female	Male
Supply voltage U <sub>B</sub>	300 V	300 V
Number of conductors x conductor cross-section	5 x max. 1.5 mm <sup>2</sup>	5 x max. 1.5 mm <sup>2</sup>
Degree of protection as per IEC 60529	IP 67	IP 67
Ambient temperature T <sub>a</sub>	-25...+80 °C	-25...+80 °C

Cable material	Color	Ordering code	
Cable dia.		Part number	
PUR 6...8 mm	Black	<b>BCC070E</b> BCC A335-0000-10-000-51X5A5-000	<b>BCC070J</b> BCC A335-0000-20-000-51X5A5-000
PUR 8...10 mm	Black	<b>BCC070F</b> BCC A335-0000-10-000-61X5A5-000	<b>BCC070K</b> BCC A335-0000-20-000-61X5A5-000
PUR 10...12 mm	Black	<b>BCC070H</b> BCC A335-0000-10-000-71X5A5-000	<b>BCC070L</b> BCC A335-0000-20-000-71X5A5-000

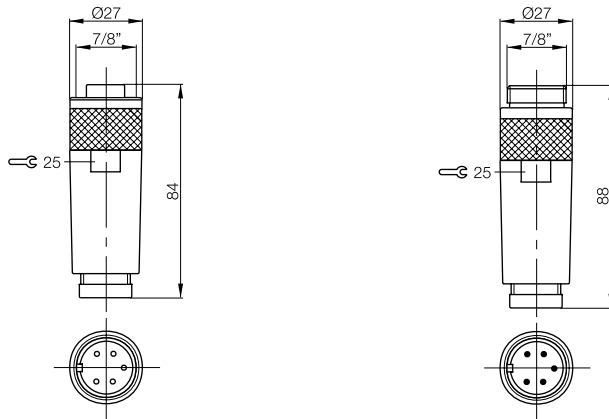

# Profinet Power tee



Profibus  
 Profinet  
 Product topology  
 IO-Link modules  
 Modules  
 Power cables  
**Power connectors**  
**Power tee**  
 Bus couplings  
 Bus cables  
 Bus connectors  
 Accessories  
 CC-Link  
 Devicenet  
 Ethernet/IP  
 Unmanaged switches

Connector diagram and wiring		
Configuration	7/8" power distributor	
Version	Standard, 5-pin	
Type	Female/male	
<b>Ordering code</b>	<b>BCC0AA7</b>	
Part number	BCC A315-A315-A315-T0023-000	
Supply voltage $U_B$	300 V AC	
Degree of protection as per IEC 60529	IP 67	
Ambient temperature $T_a$	-40...+90 °C	
Housing material	Plastic	

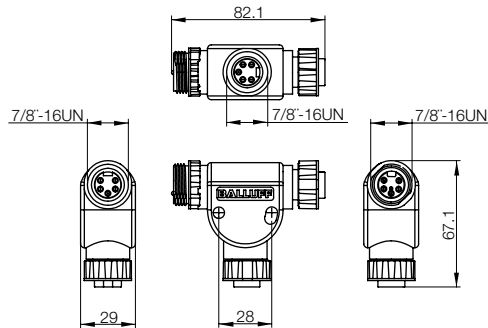





Connector diagram and wiring

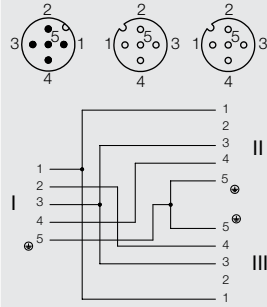

Description	T splitter	Screw plug 7/8"	Screw plug 7/8"
Use	2x M12 female to 1x M12 male	Cover for the power ports	Cover for the power ports
<b>Ordering code</b>	<b>BCC089P</b>	<b>BAM012T</b>	<b>BAM012U</b>
Part number	BCC M415-M415-M415-U0003-000	BKS-7/8-CS-00-A	BKS-7/8-CS-00-I
Supply voltage $U_b$	125 V		
Rated operating current $I_o$	4 A		
Degree of protection as per IEC 60529	IP 67		
Ambient temperature $T_a$	-25...+80 °C	-20...+80 °C	-20...+80 °C
Housing material	PA 6.6 + GF	Nickel-plated CuZn	Nickel-plated CuZn

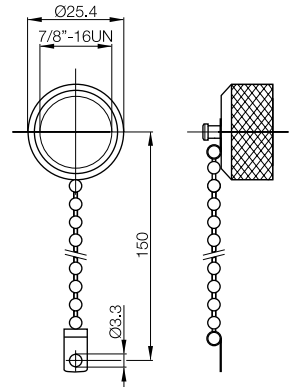
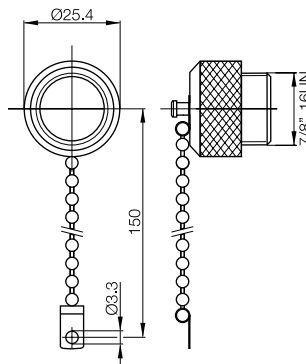
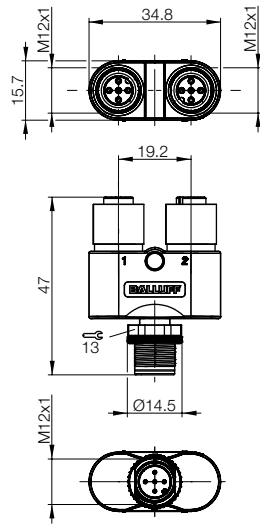

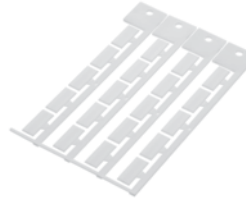

Profibus  
Profinet  
Product topology  
IO-Link modules  
Modules  
Power cables  
Power connectors  
Power tee  
Bus couplings  
Bus cables  
Bus connectors  
**Accessories**  
CC-Link  
Devicenet  
Ethernet/IP  
Unmanaged switches

Description	M12 locking screw	Marking sleeve	Label set	
Use	IP 65 screw plug for unused ports	For labeling connectors	Labeling the ports for modules BNI PBS..., BNI PNT..., BNI DNT..., BNI EIP..., BNI CCL...	
<b>Ordering code</b>	<b>BAM01C2</b>		<b>BAM01AT</b>	
Part number	BAM CS-XA-002-M12-A	BAM IA-CC-002-01	BNI ACC-L01-000	
Ambient temperature T <sub>a</sub>	-20...+80 °C			
Housing material	Plastic		Plastic	

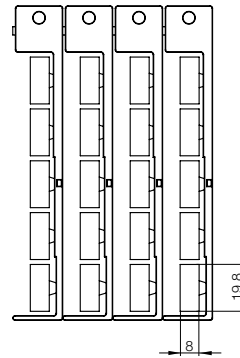
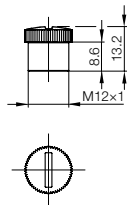

3-wire connector BCC; see the chapter "Connectors and Cables" beginning on **page 270**.



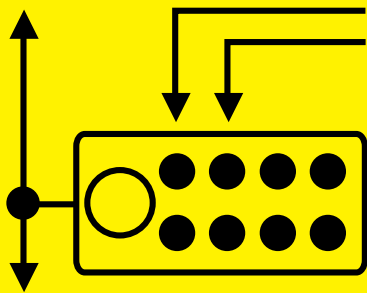

# Fieldbus Systems

## Fieldbus System: CC-Link

CC-Link is the most dominant and fastest growing fieldbus technology in Asia. The open network is supported by the global CC-Link partner association CLPA, which comprises more than 1000 companies.

CC-Link is a standardized fieldbus designed to integrate different automation components from a wide range of providers. CC-Link is an effective integral system that will fulfill 100% of your application requirements.

Utilize our extensive, high-quality CC-Link portfolio to implement your own powerful control topologies using products from a single source.





Product topology	62
IO-Link modules	64
Modules	64
Power cables	66
Power tee	70
Bus cables	68
Bus connectors	69
Terminating resistor	70
Accessories	71

**Trunk and drop**

- Very simple troubleshooting
- A single device can be disconnected without disrupting the network
- Extra cable requirements result in higher costs

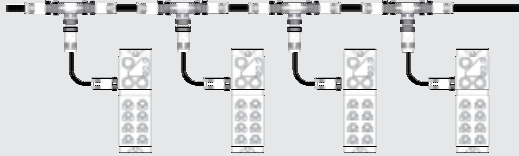

**Connected in series**

- Difficult troubleshooting
- Disconnecting a device interrupts the network
- Lower costs due to fewer cabling components

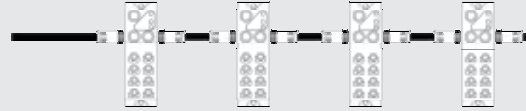

**Clearly visible status LEDs**

Low-quality LEDs that are often difficult to identify under demanding production conditions perform poorly when used in high-speed applications. Unlike Balluff status LEDs, which are large, bright, highly visible and provide maximum assistance. Balluff quality will help you complete setup and maintenance tasks and reduce machine downtimes with ease.



**Powerful and safe outputs**

With an output current of up to **2 amps**, Balluff output modules are capable of driving almost any load. Each output also offers an overload protection with LED indicator and a memory feature for easy troubleshooting.

**Robust, full-metal housing**

The fully encapsulated housing can withstand impacts, shaking, corrosive fluids, as well as people stepping on it and costs the same as a plastic housing.

**Addressable display**

IP address, subnet mask and gateway address appear on the illuminated display. Push buttons can be used to set each octet of the addresses specified above. The display can be disabled via the PLC (controller).

**Inputs with high density**

All Balluff input blocks offer two input points for each connector, accessed via a V splitter. A DESINA output is also optionally available via pin 2.

**Innovative housing design**

The extra-flat profile reduces potential dangers posed by cables. Rounded corners offer highly visible locations for channel markers and two mounting points are sufficient to secure the robust metal housing.

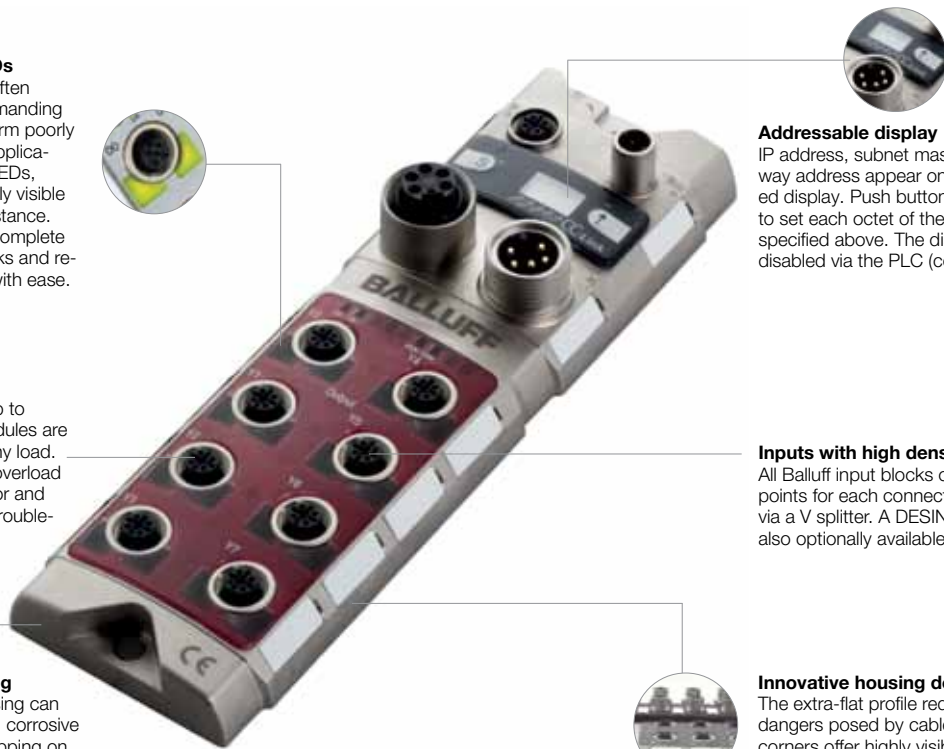

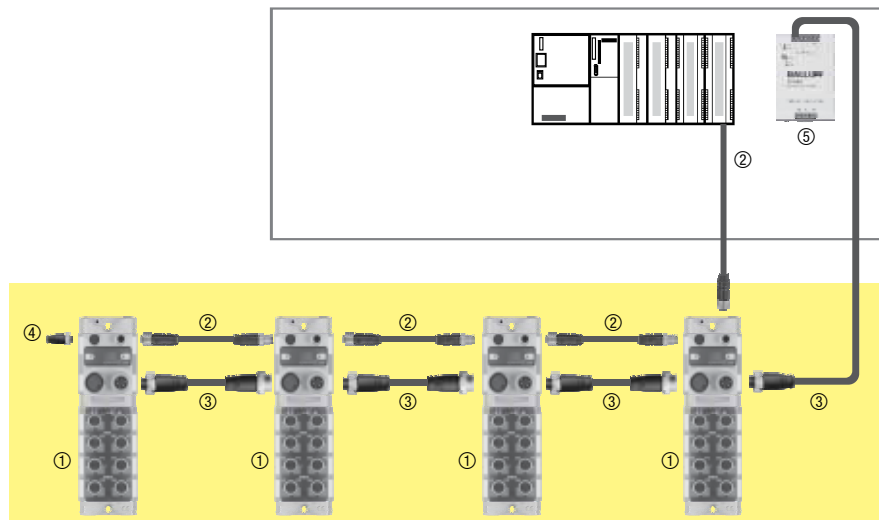

- |                               |          |
|-------------------------------|----------|
| ① <b>CC-Link module BNI</b>   | Page 64  |
| ② <b>Bus cable BCC</b>        | Page 68  |
| ③ <b>Power cable BCC</b>      | Page 66  |
| ④ <b>Terminating resistor</b> | Page 70  |
| ⑤ <b>Power supplies BAE</b>   | Page 365 |

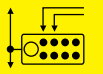

Profibus  
Profinet  
CC-Link  
**Product topology**  
IO-Link modules  
Modules  
Power cables  
Power tee  
Bus cables  
Bus connectors  
Terminating resistor  
Accessories  
Devicenet  
Ethernet/IP  
Unmanaged switches

CC-Link IO distributors are exceptionally well-suited for use in harsh industrial environments and enable the consistent, cost-optimized fulfillment of requirements for decentralized installation technology.

#### CC-Link advantages

- Constant data throughput, even when processing large data volumes
- Deterministic response for reliable realtime control
- Controllers programmed over the network
- Powerful diagnostic system for clear identification of problem areas
- Network stations switched on and off during operation
- Network stations restored automatically
- Standby master function
- Optional configuration software

#### Industries

- Semiconductor industry
- Automotive industry
- Food and beverage industry
- Pharmaceutical industry

- Clearly visible status LEDs
- Addressable display
- Powerful and reliable outputs
- Innovative housing design

## CC-Link with IO-Link functionality

A module with four IO-Link ports is now available in addition to the CC-Link fieldbus modules.

The IO-Link master ports can be configured and used entirely independently of one another, which means there are four additional freely configurable standard I/O ports available, which provide you with another eight inputs/outputs for standard sensors and actuators.



Fieldbus Version	CC-Link	CC-Link	
Ordering code	<b>BNI0040</b>	<b>BNI0049</b>	
Part number	BNI CCL-502-100-Z001	BNI CCL-106-100-Z001	
Supply voltage $U_B$	18...30 V DC	18...30 V DC	
Function indicator	Green LED	Green LED	
Fault function indicator	Red LED	Red LED	
Power-on indicator	Green LED	Module/actuator/sensor supply	
Connection: Fieldbus	M12, 5-pin, female and male	M12, 5-pin, female and male	
Supply voltage connection	7/8", 5-pin, female and male	7/8", 5-pin, female and male	
Connection: I/O ports	M12, A-coded, female	M12, A-coded, female	
No. of I/O ports	8	8	
Number of inputs	max. 12 PNP	16 NPN	
Number of outputs	max. 12 PNP		
Configurable inputs/outputs	Yes	No	
Max. load current, sensors/channel	200 mA	200 mA	
Max. load current, output	1.6 A/2 A		
Port status indicator (signal status)	Yellow LED	Yellow LED	
Port diagnostic indicator (overload)	Red LED	Red LED	
Total current $U_{Actuator}$	$\leq 9$ A	$\leq 9$ A	
Total current $U_{Sensor}$	$\leq 9$ A	$\leq 9$ A	
Degree of protection as per IEC 60529	IP 67 (when screwed into place)	IP 67 (when screwed into place)	
Operating temperature $T_a$	-5...+70 °C	-5...+55 °C	
Storage temperature	-25...+70 °C	-25...+75 °C	
Weight	Approx. 577 g	Approx. 577 g	
Fastener	2 mounting holes	2 mounting holes	
Dimensions (LxWxH)	224x68x36.9 mm	224x68x36.9 mm	
Housing material	Nickel-plated GdZn	Nickel-plated GdZn	



## IO-Link Version 1.1

No. of IO-Link master ports	4x master
Operating modes (3-wire)	SIO, COM 1, COM 2, COM 3
Indicators	Communication: Green LED Error: Red LED
Max. load current for IO-Link device	1.6 A

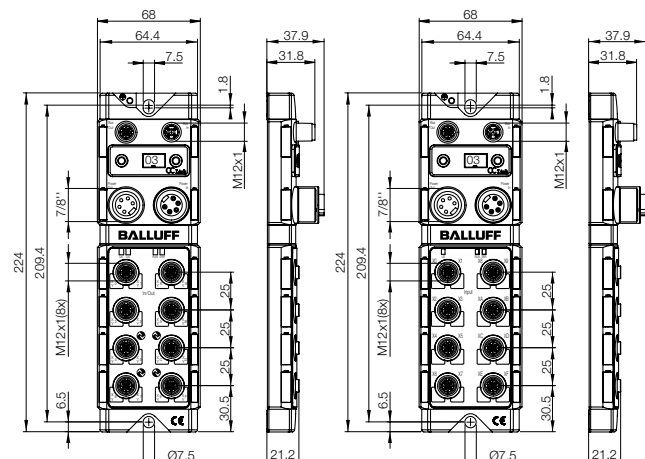

All modules include four screw plugs and a label set.



# CC-Link Modules



Profibus  
Profinet  
CC-Link  
Product topology  
**IO-Link modules**  
**Modules**  
Power cables  
Power tee  
Bus cables  
Bus connectors  
Terminating resistor  
Accessories  
Devicenet  
Ethernet/IP  
Unmanaged switches

	CC-Link 16 DI PNP	CC-Link 16 DI/DO PNP	CC-Link 8 DI + 8 DO PNP	CC-Link 8 DO
	<b>BNI002F</b>	<b>BNI002A</b>	<b>BNI002C</b>	<b>BNI002E</b>
	BNI CCL-104-100-Z001	BNI CCL-302-100-Z001	BNI CCL-305-100-Z001	BNI CCL-202-100-Z001
	18...30 V DC	18...30 V DC	18...30 V DC	18...30 V DC
	Green LED	Green LED	Green LED	Green LED
	Red LED	Red LED	Red LED	Red LED
	Module/actuator/sensor supply	Module/actuator/sensor supply	Module/actuator/sensor supply	Module/actuator/sensor supply
	M12, 5-pin, female and male	M12, 5-pin, female and male	M12, 5-pin, female and male	M12, 5-pin, female and male
	7/8", 5-pin, female and male	7/8", 5-pin, female and male	7/8", 5-pin, female and male	7/8", 5-pin, female and male
	M12, A-coded, female	M12, A-coded, female	M12, A-coded, female	M12, A-coded, female
	8	8	8	8
	16 PNP	max. 16 PNP	8 PNP	8 PNP
	No	Yes	No	No
	200 mA	200 mA	200 mA	200 mA
		2 A	2 A	2 A
	Yellow LED	Yellow LED	Yellow LED	Yellow LED
	Red LED	Red LED	Red LED	Red LED
	≤ 9 A	≤ 9 A	≤ 9 A	≤ 9 A
	≤ 9 A	≤ 9 A	≤ 9 A	≤ 9 A
	IP 67 (when screwed into place)	IP 67 (when screwed into place)	IP 67 (when screwed into place)	IP 67 (when screwed into place)
	-5...+55 °C	-5...+55 °C	-5...+55 °C	-5...+55 °C
	-25...+75 °C	-25...+75 °C	-25...+75 °C	-25...+75 °C
	Approx. 577 g	Approx. 577 g	Approx. 577 g	Approx. 577 g
	2 mounting holes	2 mounting holes	2 mounting holes	2 mounting holes
	224×68×36.9 mm	224×68×36.9 mm	224×68×36.9 mm	224×68×36.9 mm
	Nickel-plated GdZn	Nickel-plated GdZn	Nickel-plated GdZn	Nickel-plated GdZn

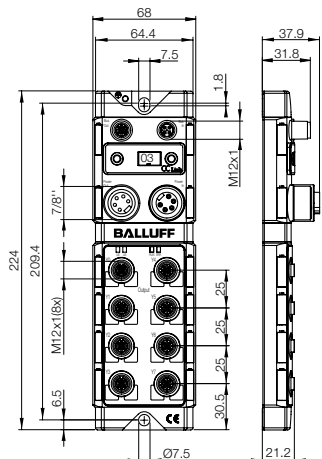
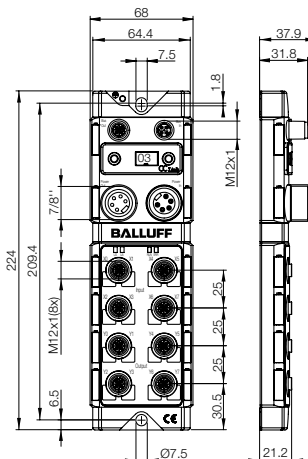
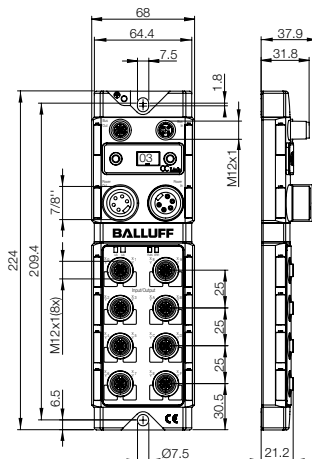
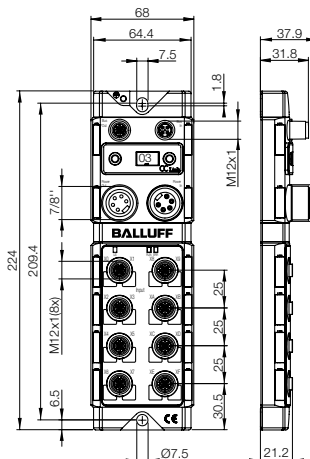

# CC-Link

## Power cables 7/8", 5-pin



Connector diagram and wiring

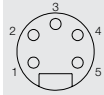

PIN 1: black  
PIN 2: blue  
PIN 3: green/yellow  
PIN 4: brown  
PIN 5: white

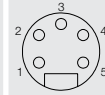

PIN 1: black  
PIN 2: blue  
PIN 3: green/yellow  
PIN 4: brown  
PIN 5: white



Type	Female	Female
Supply voltage $U_b$	300 V DC	300 V DC
Number of conductors × conductor cross-section	5×1.5 mm <sup>2</sup>	5×1.5 mm <sup>2</sup>
Degree of protection as per IEC 60529	IP 68	IP 68
Ambient temperature $T_a$	-25...+80 °C	-25...+80 °C

Cable material	Color	Length	Ordering code	
			Part number	
PUR	Black	0.6 m		
PUR	Black	2 m	<b>BCC06HC</b> BCC A315-0000-10-063-PX05A5-020	<b>BCC06HH</b> BCC A325-0000-10-063-PX05A5-020
PUR	Black	5 m	<b>BCC06HE</b> BCC A315-0000-10-063-PX05A5-050	<b>BCC06HJ</b> BCC A325-0000-10-063-PX05A5-050
PUR	Black	10 m	<b>BCC06HF</b> BCC A315-0000-10-063-PX05A5-100	<b>BCC06HK</b> BCC A325-0000-10-063-PX05A5-100
PUR	Black	15 m		

Other cable materials, colors, and lengths on request.

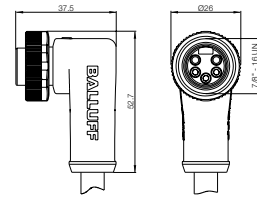

# CC-Link

## Power connection cables 7/8", 5-pin



Profibus  
 Profinet  
 CC-Link  
 Product topology  
 IO-Link modules  
 Modules  
**Power cables**  
 Power tee  
 Bus cables  
 Bus connectors  
 Terminating resistor  
 Accessories  
 Devicenet  
 Ethernet/IP  
 Unmanaged switches

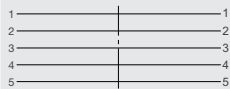
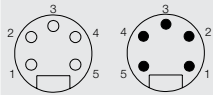

Female/male  
 300 V DC  
 5x1.5 mm<sup>2</sup>  
 IP 68  
 -25...+80 °C

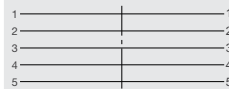
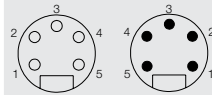

Female/male  
 300 V DC  
 5x1.5 mm<sup>2</sup>  
 IP 68  
 -25...+80 °C

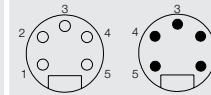

Female/male  
 300 V DC  
 5x1.5 mm<sup>2</sup>  
 IP 68  
 -25...+80 °C

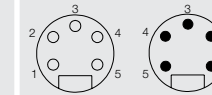

Female/male  
 300 V DC  
 5x1.5 mm<sup>2</sup>  
 IP 68  
 -25...+80 °C



### Ordering code



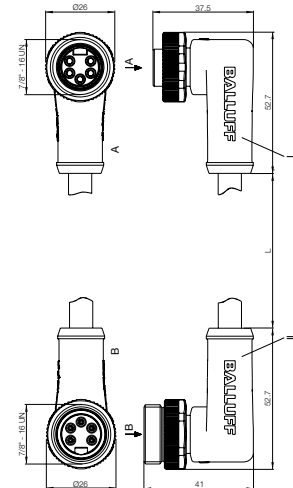
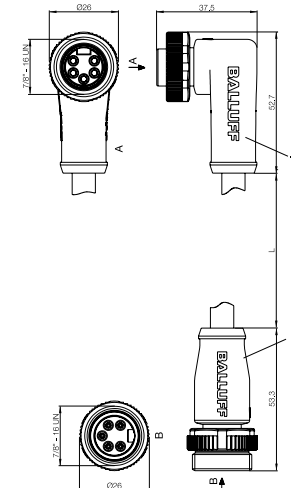
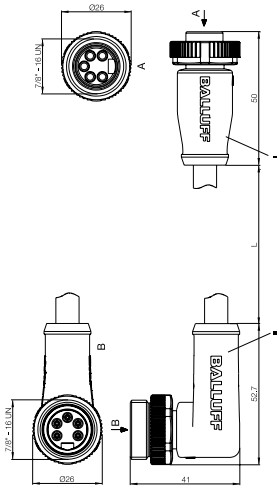
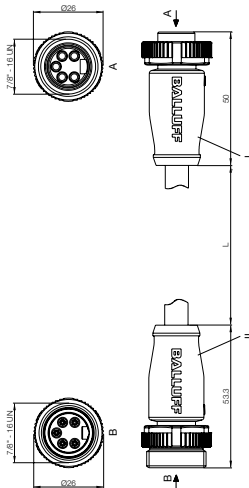

Part number

BCC06FM	BCC06FU	BCC06H1	BCC06H6
BCC A315-A315-30-335-PX05A5-006	BCC A315-A325-30-335-PX05A5-006	BCC A325-A315-30-335-PX05A5-006	BCC A325-A325-30-335-PX05A5-006
BCC06FN	BCC06FW	BCC06H2	BCC06H7
BCC A315-A315-30-335-PX05A5-020	BCC A315-A325-30-335-PX05A5-020	BCC A325-A315-30-335-PX05A5-020	BCC A325-A325-30-335-PX05A5-020
BCC06FP	BCC06FY	BCC06H3	BCC06H8
BCC A315-A315-30-335-PX05A5-050	BCC A315-A325-30-335-PX05A5-050	BCC A325-A315-30-335-PX05A5-050	BCC A325-A325-30-335-PX05A5-050
BCC06FR	BCC06FZ	BCC06H4	BCC06H9
BCC A315-A315-30-335-PX05A5-100	BCC A315-A325-30-335-PX05A5-100	BCC A325-A315-30-335-PX05A5-100	BCC A325-A325-30-335-PX05A5-100
BCC06FT	BCC06H0	BCC06H5	BCC06HA
BCC A315-A315-30-335-PX05A5-150	BCC A315-A325-30-335-PX05A5-150	BCC A325-A315-30-335-PX05A5-150	BCC A325-A325-30-335-PX05A5-150

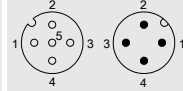



Connector diagram and wiring	 <p>PIN 1: shield PIN 2: white PIN 3: yellow PIN 4: blue</p>	 <p>PIN 1: shield PIN 2: white PIN 3: yellow PIN 4: blue</p>	 <p>PIN 1: shield PIN 2: white PIN 3: yellow PIN 4: blue</p>
Type	Female	Male	Female/male
Supply voltage $U_B$	250 V	250 V	250 V
Number of conductors $\times$ conductor cross-section	3 $\times$ 1 $\times$ AWG20	3 $\times$ 1 $\times$ AWG20	3 $\times$ 1 $\times$ AWG20
Degree of protection as per IEC 60529	IP 67	IP 67	IP 67
Ambient temperature $T_a$	-25...+70 °C	-25...+70 °C	-25...+70 °C

Cable material	Color	Length	Ordering code		
			Part number		
PVC		Red	0.6 m		<b>BCC06WU</b> BCC M415-M414-3A-337-VS24N7-006
PVC		Red	2 m	<b>BCC06Y1</b> BCC M415-0000-1A-068-VS24N7-020	<b>BCC084R</b> BCC M414-0000-2A-068-VS24N7-020
PVC		Red	5 m	<b>BCC06Y2</b> BCC M415-0000-1A-068-VS24N7-050	<b>BCC084T</b> BCC M414-0000-2A-068-VS24N7-050
PVC		Red	10 m	<b>BCC06Y3</b> BCC M415-0000-1A-068-VS24N7-100	<b>BCC084U</b> BCC M414-0000-2A-068-VS24N7-100
PVC		Red	15 m		<b>BCC06WZ</b> BCC M415-M414-3A-337-VS24N7-100
					<b>BCC06Y0</b> BCC M415-M414-3A-337-VS24N7-150

Other cable materials, colors and lengths on request.

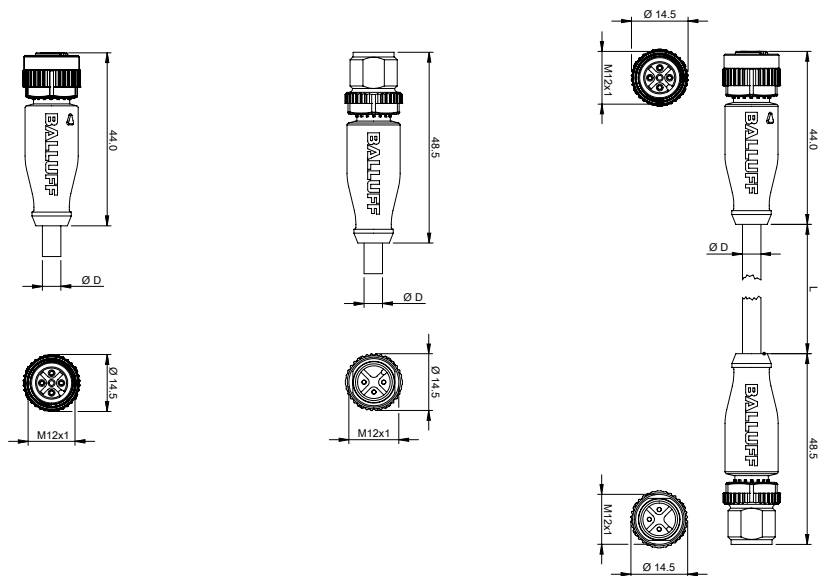

# CC-Link

## Bus connector M12, 4-pin, A-coded, User-fabricated, shieldable



Profibus  
 Profinet  
 CC-Link  
 Product topology  
 IO-Link modules  
 Modules  
 Power cables  
 Power tee  
**Bus cables**  
**Bus connectors**  
 Terminating resistor  
 Accessories  
 Devicenet  
 Ethernet/IP  
 Unmanaged switches

Connector diagram				
Version	M12 male, straight	M12 male, straight	M12 female straight	M12 female straight
Max. supply voltage AC $U_B$	250 V AC	250 V AC	250 V AC	250 V AC
Max. supply voltage DC $U_B$	250 V DC	250 V DC	250 V DC	250 V DC
Cable	User-fabricated	User-fabricated	User-fabricated	User-fabricated
Number of conductors × conductor cross-section	4×0.14...0.75 mm <sup>2</sup>	4×0.14...0.50 mm <sup>2</sup>	4×0.14...0.75 mm <sup>2</sup>	4×0.14...0.50 mm <sup>2</sup>
Connection	Screw terminal	Spring clamp terminal	Screw terminal	Spring clamp terminal
Degree of protection as per IEC 60529	IP 67	IP 67	IP 67	IP 67
Ambient temperature $T_a$	-40...+85 °C	-25...+85 °C	-40...+85 °C	-25...+85 °C

Cable dia.	Ordering code			
	Part number			
6...8 mm	<b>BCC06F7</b> BCC M434-0000-2A-000-51X475-000	<b>BCC06Y5</b> BCC M434-0000-2A-000-55X450-000	<b>BCC06F6</b> BCC M435-0000-1A-000-51X475-000	<b>BCC06Y6</b> BCC M435-0000-1A-000-55X450-000

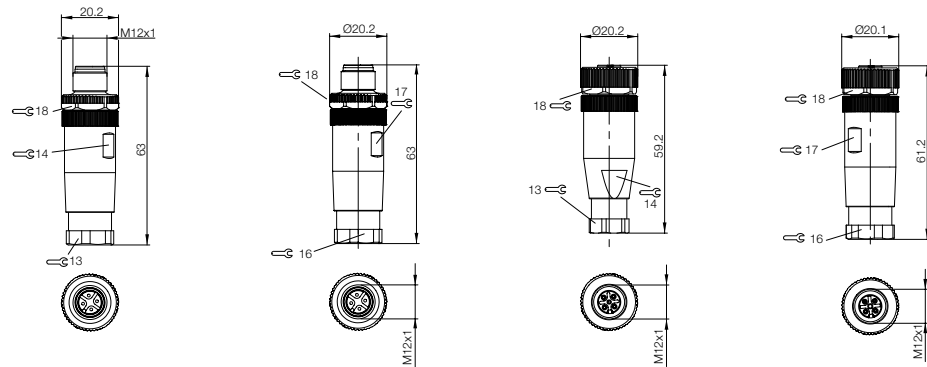



Connector diagram and wiring	<p>The first diagram shows three views of the 5-pin power tee connector with pins numbered 1 to 5. The second diagram is a wiring schematic showing a 5-pin cable connected to a 5-pin cable. The third diagram shows the 5-pin terminating resistor with pins numbered 1 to 5 and a resistor R1 connected between pins 3 and 4.</p>	
Configuration	7/8" power distributor	M12 terminating resistor
Version	Standard, 5-pin	A-coded, 5-pin
Type	Female/male	
<b>Ordering code</b>	<b>BCC0AA7</b>	<b>BCC06Y4</b>
Part number	BCC A315-A315-A315-T0023-000	BCC M415-0000-2A-R03
Supply voltage $U_b$	300 V AC	10...30 V DC
Degree of protection as per IEC 60529	IP 67	IP 67
Ambient temperature $T_a$	-40...+90 °C	-40...+85 °C
Housing material	Plastic	Plastic

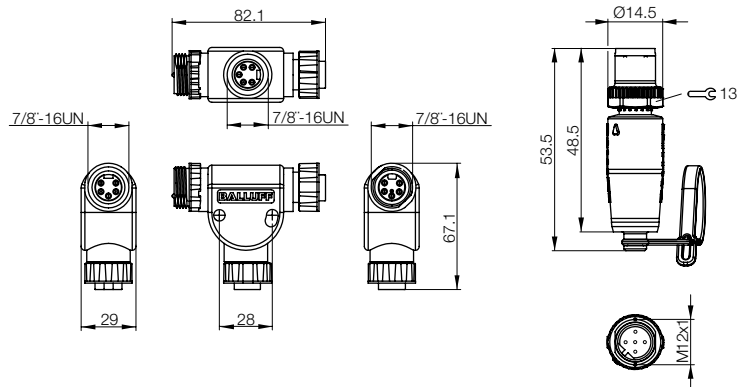



Profibus  
Profinet  
CC-Link  
Product topology  
IO-Link modules  
Modules  
Power cables  
**Power tee**  
Bus cables  
Bus connectors  
**Terminating resistor**  
**Accessories**  
Devicenet  
Ethernet/IP  
Unmanaged switches



Connector diagram and wiring			
Description	T splitter	Screw plug 7/8"	Screw plug 7/8"
Use	2x M12 female to 1x M12 male	Cover for the power ports	Cover for the power ports
<b>Ordering code</b>	<b>BCC089P</b>	<b>BAM012T</b>	<b>BAM012U</b>
Part number	BCC M415-M415-M415-U0003-000	BKS-7/8-CS-00-A	BKS-7/8-CS-00-I
Supply voltage $U_B$	125 V		
Rated operating current $I_B$	4 A		
Degree of protection as per IEC 60529	IP 67		
Ambient temperature $T_a$	-25...+80 °C	-20...+80 °C	-20...+80 °C
Housing material	PA 6.6 + GF	Nickel-plated CuZn	Nickel-plated CuZn

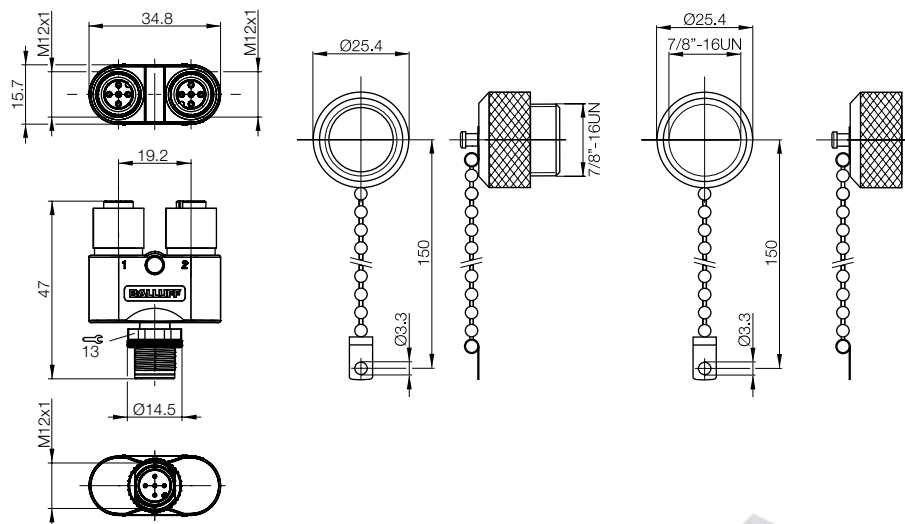

Description	M12 locking screw	Marking sleeve	Label set
Use	IP 65 screw plug for unused ports	For labeling connectors	Labeling the ports for modules BNI PBS..., BNI PNT..., BNI DNT..., BNI EIP..., BNI CCL...
<b>Ordering code</b>	<b>BAM01C2</b>		<b>BAM01AT</b>
Part number	BAM CS-XA-002-M12-A	BAM IA-CC-002-01	BNI ACC-L01-000
Housing material	Plastic		Plastic



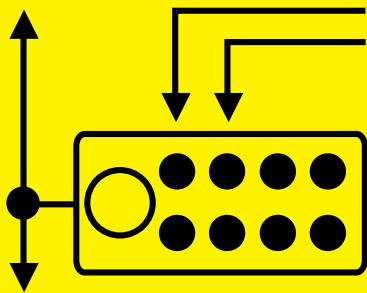

# Fieldbus Systems

## Fieldbus System: Devicenet

For a simple choice of outstanding network components, Balluff offers the entire spectrum of high-performance network technology. For applications in the USA, such as with Rockwell Automation and other controller manufacturers, we can provide you with all of the modules for efficient Devicenet implementation. For simple installation, speedy integration through direct mounting as well as the possibility of fast modifications. And all of this completely independent of controller manufacturer. You save time and lower costs.

Choose an efficient field and process combination using our components. We give you the choice of a combination regardless of controller manufacturer, letting you easily choose based on your requirements and utilize our comprehensive, fully developed Networking and Connectivity product line that leaves nothing to be desired beyond the control cabinet.





Product topology	74
IO-Link modules	76
Modules	77
Bitmaps	79
Power cables	82
Power tees	88
Power plug connectors	89
Bus cables	80
Bus terminating resistors	86
Bus tee	87
Accessories	90
Analyzer	92

# Devicenet

## Product topology

### The best I/O modules in the industry

Impressive features. Impressive functionality.  
Impressive performance

### Clearly visible status LEDs

Low-quality LEDs that are often difficult to identify under demanding production conditions perform poorly when used in high-speed applications. Unlike Balluff status LEDs, which are large, bright, highly visible and provide maximum assistance. Balluff quality will help you complete setup and maintenance tasks and reduce machine downtimes with ease.

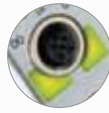

### Powerful and safe outputs

With an output current of up to **2 amps**, Balluff output modules are capable of driving almost any load. Each output also offers overload protection with LED indicator and a memory feature for easy troubleshooting.

### Robust, full-metal housing

The fully encapsulated housing can withstand impacts, shaking, corrosive fluids, as well as people stepping on it and costs the same as a plastic housing.

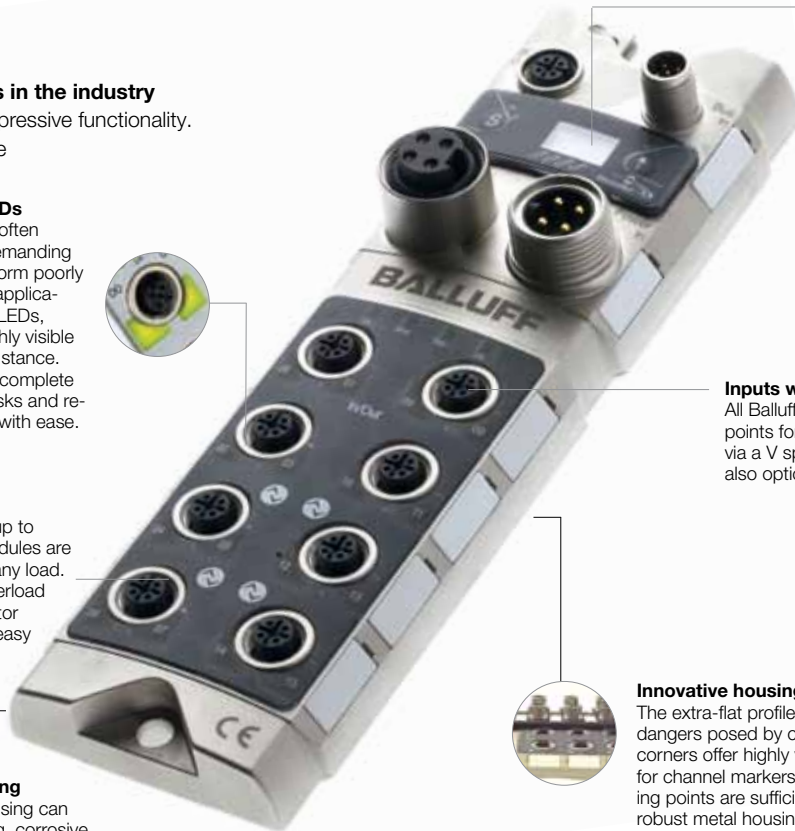

### Addressable display

IP address, subnet mask and gateway address appear on the illuminated display. Push buttons can be used to set each octet of the addresses specified above. The display can be disabled via the PLC (controller).



### Inputs with high density

All Balluff input blocks offer two input points for each connector, accessed via a V splitter. A DESINA output is also optionally available via pin 2.

### Innovative housing design

The extra-flat profile reduces potential dangers posed by cables. Rounded corners offer highly visible locations for channel markers and two mounting points are sufficient to secure the robust metal housing.



### Devicenet™ system concept from Balluff

Machine design should not be restricted by inflexible network topology. Balluff Devicenet™ products comprise cables, tees and hubs that you can use to combine elements of all topologies with one another. Flexible installation is ensured by raw cables, connection cables and color-coded, field-attachable connectors.

#### Trunk and drop

- Very simple troubleshooting
- A single device can be disconnected without disrupting the network
- Extra cable requirements result in higher costs

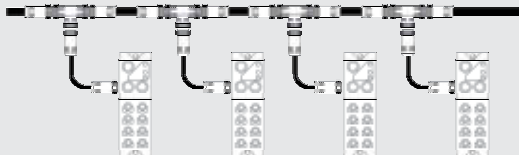

#### Connected in series

- Difficult troubleshooting
- Disconnecting a device interrupts the network
- Lower costs due to fewer cabling components

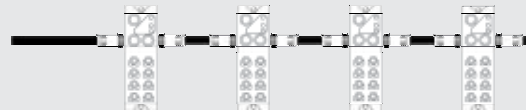

#### Star

- Simple troubleshooting
- Ideal for large I/O clusters
- Less expensive – only one splitter box needed

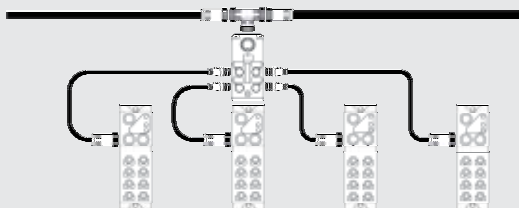

#### Mixed topology

- Creation of logical groups results in relatively simple troubleshooting
- Popular method – ideal cost/benefit ratio

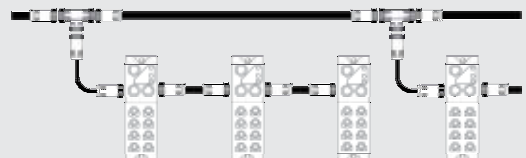

## Complete Devicenet™ product matrix

Precisely adapted cables and accessory parts are required to maximize utilization of the I/O blocks. Balluff offers all the components you need for constructing and maintaining a world-class Devicenet™ network.

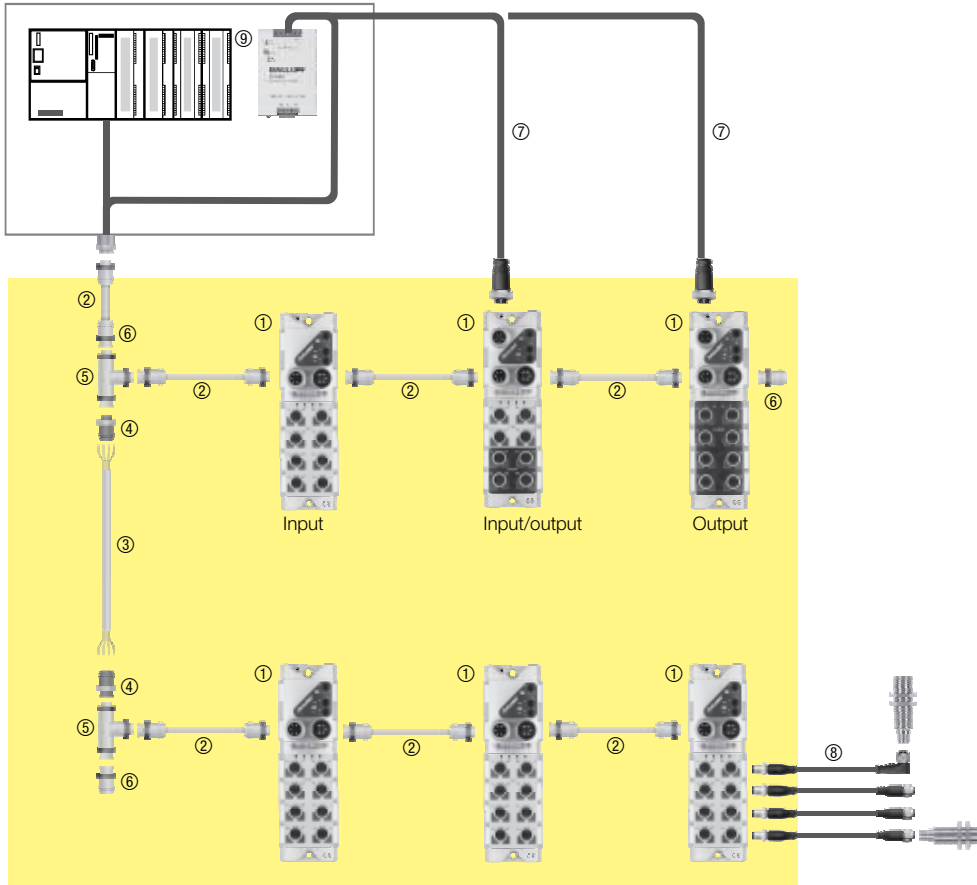

- |                                       |          |
|---------------------------------------|----------|
| ① Devicenet modules BNI               | Page 76  |
| ② Bus cables BCC                      | Page 80  |
| ③ Network cables                      |          |
| ④ Field attachable bus connectors BCC | Page 89  |
| ⑤ Bus tees BCC                        | Page 87  |
| ⑥ Bus terminating resistors BCC       | Page 86  |
| ⑦ Power cables BCC                    | Page 82  |
| ⑧ Connection cables BCC               | Page 336 |
| ⑨ Power supplies BAE                  | Page 365 |



Profibus  
Profinet  
CC-Link  
Devicenet  
**Product topology**  
IO-Link modules  
Modules  
Bitmaps  
Power cables  
Power tees  
Power connectors  
Bus cables  
Bus terminating resistor  
Bus tee  
Accessories  
Analyzer  
Ethernet/IP  
Unmanaged switches

## BNI DNT-502-100-Z001

- 4 IO-Link master ports
- SIO, COM 1, COM 2, COM 3
- IO-Link version 1.1
- 4 additional I/O ports
- 16 I/O max.

## BNI DNT-104-000-Z004

- 16 PNP inputs on 8 connections powered by the Devicenet™ network
- Short-circuit protected
- Short-circuit diagnostics
- I/O size: 4-byte input, 0-byte output

## BNI DNT-202-000-Z005

- 8 sourcing outputs supplied via auxiliary power source
- Rated output current 2 A
- Resettable latching overload diagnostics at point level
- I/O size: 3-byte input, 2-byte output

## BNI DNT-302-000-Z005

- 16 points configured as PNP inputs or sourcing outputs
- Inputs and outputs powered via auxiliary power source
- Rated output current 1.6 A
- Short circuit at point level and resettable overload diagnostics
- I/O size: 7-byte input, 4-byte output



Fieldbus	Devicenet
Version	4x IO-Link, 16x I/O
<b>Ordering code</b>	<b>BNI005A</b>
Part number	BNI-DNT-502-100-Z001
Supply voltage $U_b$	18...30 V DC
Indicators/input	Display/pushbutton
Net function indicator	Green LED
Fault function indicator	Red LED
Module status indicator: Mod LED	Yes
Network status indicator: Net LED	Yes
Port status indicator	Black, red, yellow
Power-on indicator	$V_A$ , $V_S$ , undervoltage
Connection: Fieldbus	M12, B coded, socket/plug
Supply voltage connection	7/8", male, 5-pin
Connection: I/O ports	M12, A-coded, female
No. of I/O ports	8
Number of inputs	max. 16
Number of outputs	max. 16
Configurable	Yes
Max. load current, sensors/channel	200 mA
Max. load current, output	1.6 A/2 A
Port status indicator (signal status)	Yellow LED
Port diagnostic indicator (overload)	Red LED
Total current $U_{Actuator}$	< 9 A
Total current $U_{Sensor}$	< 9 A
Degree of protection as per IEC 60529	IP 67 (when screwed into place)
Operating temperature $T_a$	-5...+70 °C
Storage temperature	-25...+70 °C
Weight	Approx. 580 g
Fastener	2 mounting holes
Dimensions (LxWxH)	225x68x36.9 mm
Housing material	Nickel-plated GdZn



## IO-Link Version 1.1

No. of IO-Link master ports	4x master
Operating modes (3-wire)	SIO, COM 1, COM 2, COM 3
Indicators	Communication Error
	Green LED Red LED
Max. load current for IO-Link device	1.6 A

All modules include four screw plugs and a label set.

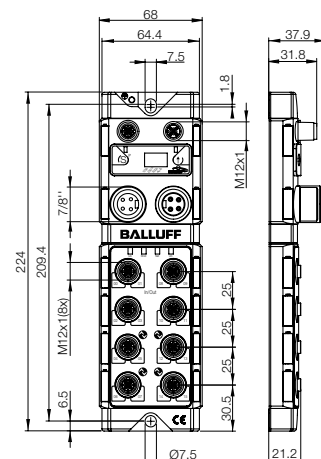

# Devicenet Modules



Profibus  
 Profinet  
 CC-Link  
 Devicenet  
 Product topology  
**IO-Link modules**  
**Modules**  
 Bitmaps  
 Power cables  
 Power tees  
 Power connectors  
 Bus cables  
 Bus terminating resistor  
 Bus tee  
 Accessories  
 Analyzer  
 Ethernet/IP  
 Unmanaged switches

Devicenet	Devicenet	Devicenet
16 DI	8 DO	16 DI/DO
<b>BNI0001</b>	<b>BNI0002</b>	<b>BNI0003</b>
BNI-DNT-104-000-Z004	BNI-DNT-202-000-Z005	BNI-DNT-302-000-Z005
18...30 V DC	18...30 V DC	18...30 V DC
Green LED Red LED	Green LED Red LED	Green LED Red LED
Module	Module, actuators	Module, sensors, actuators
7/8" 5-pin female and male	7/8" 5-pin female and male 7/8" 4-pin male	7/8" 5-pin female and male 7/8" 4-pin male
M12, A-coded, male	M12, A-coded, male	M12, A-coded, male
8	8	8
16 PNP	8 PNP	16 PNP 16 PNP
No	No	Yes
200 mA	2 A	2 A
Green LED Red LED	Green LED Red LED	Green LED Red LED
< 9 A	< 9 A	< 9 A
IP 67 (when screwed into place)	IP 67 (when screwed into place)	IP 67 (when screwed into place)
-5...+70 °C	-5...+70 °C	-5...+70 °C
-25...+85 °C	-25...+85 °C	-25...+85 °C
Approx. 580 g	Approx. 580 g	Approx. 580 g
2 mounting holes	2 mounting holes	2 mounting holes
225×68×36.9 mm	225×68×36.9 mm	225×68×36.9 mm
Nickel-plated GdZn	Nickel-plated GdZn	Nickel-plated GdZn

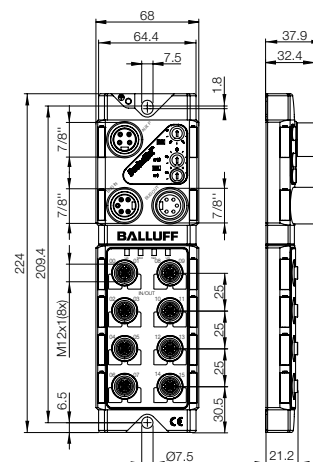
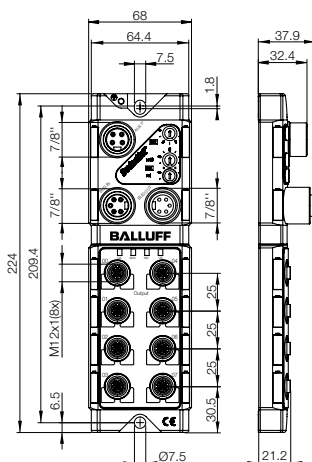
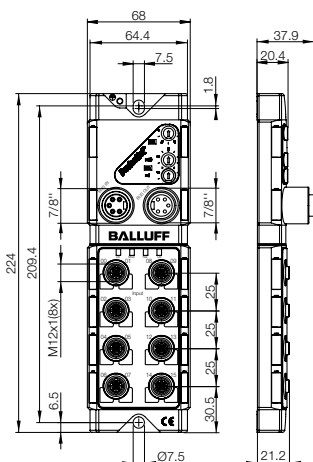



**BNI DNT-305-000-Z005**

- 8 PNP inputs and 8 sourcing outputs
- Inputs and outputs powered via auxiliary power source
- Rated output current 1.6 A
- Short circuit at point level and resettable overload diagnostics
- I/O size: 5-byte input, 2-byte output



Fieldbus	Devicenet
Version	8 DI + 8 DO
<b>Ordering code</b>	<b>BNI0004</b>
Part number	BNI-DNT-305-000-Z005
Supply voltage $U_B$	18...30 V DC
Net function indicator	Green LED
Fault function indicator	Red LED
Power-on indicator	Module, actuators
Connection: Fieldbus	7/8" 5-pin female and male
Supply voltage connection	7/8" 4-pin male
Connection: I/O ports	M12, A-coded, male
No. of I/O ports	8
Number of inputs	8 PNP
Number of outputs	8 PNP
Configurable	No
Max. load current, sensors/channel	200 mA
Max. load current, output	2 A
Port status indicator (signal status)	Green LED
Port diagnostic indicator (overload)	Red LED
Total current $U_{Actuator}$	< 9 A
Total current $U_{Sensor}$	< 9 A
Degree of protection as per IEC 60529	IP 67 (when screwed into place)
Operating temperature $T_a$	-5...+70 °C
Storage temperature	-25...+85 °C
Weight	Approx. 580 g
Fastener	2 mounting holes
Dimensions (L×W×H)	225×68×36.9 mm
Housing material	Nickel-plated GdZn

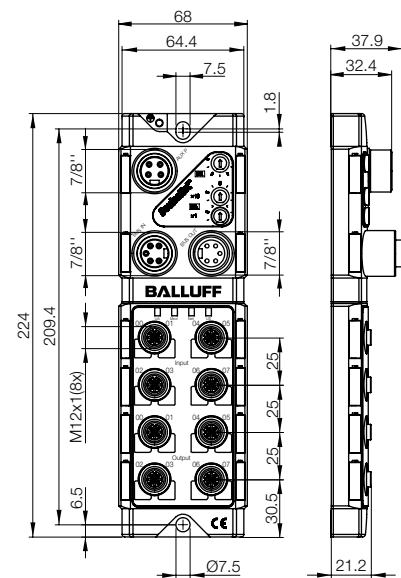

## 16 inputs (4 bytes in, 0 bytes out)

		Bit 15	Bit 14	Bit 13	Bit 12	Bit 11	Bit 10	Bit 9	Bit 8	Bit 7	Bit 6	Bit 5	Bit 4	Bit 3	Bit 2	Bit 1	Bit 0
IN	Word 0	I-15	I-14	I-13	I-12	I-11	I-10	I-9	I-8	I-7	I-6	I-5	I-4	I-3	I-2	I-1	I-0
	Word 1	S-15	S-14	S-13	S-12	S-11	S-10	S-9	S-8	S-7	S-6	S-5	S-4	S-3	S-2	S-1	S-0

## 8 outputs (3 bytes in, 2 bytes out)

		Bit 15	Bit 14	Bit 13	Bit 12	Bit 11	Bit 10	Bit 9	Bit 8	Bit 7	Bit 6	Bit 5	Bit 4	Bit 3	Bit 2	Bit 1	Bit 0
IN	Word 0	OL-7	OL-6	OL-5	OL-4	OL-3	OL-2	OL-1	OL-0	HS-7	HS-6	HS-5	HS-4	HS-3	HS-2	HS-1	HS-0
	Word 1																AP
OUT	Word 0	R-7	R-6	R-5	R-4	R-3	R-2	R-1	R-0	O-7	O-6	O-5	O-4	O-3	O-2	O-1	O-0

## 16 configurable (7 bytes in, 4 bytes out)

		Bit 15	Bit 14	Bit 13	Bit 12	Bit 11	Bit 10	Bit 9	Bit 8	Bit 7	Bit 6	Bit 5	Bit 4	Bit 3	Bit 2	Bit 1	Bit 0
IN	Word 0	I-15	I-14	I-13	I-12	I-11	I-10	I-9	I-8	I-7	I-6	I-5	I-4	I-3	I-2	I-1	I-0
	Word 1	S-15	S-14	S-13	S-12	S-11	S-10	S-9	S-8	S-7	S-6	S-5	S-4	S-3	S-2	S-1	S-0
	Word 2	OL-15	OL-14	OL-13	OL-12	OL-11	OL-10	OL-9	OL-8	OL-7	OL-6	OL-5	OL-4	OL-3	OL-2	OL-1	OL-0
	Word 3															SP	AP
OUT	Word 0	O-15	O-14	O-13	O-12	O-11	O-10	O-9	O-8	O-7	O-6	O-5	O-4	O-3	O-2	O-1	O-0
	Word 1	R-15	R-14	R-13	R-12	R-11	R-10	R-9	R-8	R-7	R-6	R-5	R-4	R-3	R-2	R-1	R-0

## 8 inputs/8 outputs (5 bytes in, 2 bytes out)

		Bit 15	Bit 14	Bit 13	Bit 12	Bit 11	Bit 10	Bit 9	Bit 8	Bit 7	Bit 6	Bit 5	Bit 4	Bit 3	Bit 2	Bit 1	Bit 0
IN	Word 0	S-7	S-6	S-5	S-4	S-3	S-2	S-1	S-0	I-7	I-6	I-5	I-4	I-3	I-2	I-1	I-0
	Word 1	OL-7	OL-6	OL-5	OL-4	OL-3	OL-2	OL-1	OL-0	HS-7	HS-6	HS-5	HS-4	HS-3	HS-2	HS-1	HS-0
	Word 2															SP	AP
OUT	Word 0	R-7	R-6	R-5	R-4	R-3	R-2	R-1	R-0	O-7	O-6	O-5	O-4	O-3	O-2	O-1	O-0

Bitmap legend	
I	Input
O	Output
R	Output reset
S	Input short-circuit
OL	Output overload status
HS	Output handshake
AP	Actuator power status
SP	Sensor/network power status

- 
- Profibus
  - Profinet
  - CC-Link
  - Devicenet
  - Product topology
  - IO-Link modules
  - Modules**
  - Bitmaps**
  - Power cables
  - Power tees
  - Power connectors
  - Bus cables
  - Bus terminating resistor
  - Bus tee
  - Accessories
  - Analyzer
  - Ethernet/IP
  - Unmanaged switches





Bus cables 7/8", 5-pin, thin

Transfer rate	Cable	
	thick	thin
125 kbs baud rate	500 m	100 m
250 kbs baud rate	250 m	100 m
500 kbs baud rate	100 m	100 m





Connector diagram and wiring	Female straight	Male straight	Female straight/Male straight
<p>PIN 1: shield PIN 2: red PIN 3: black PIN 4: white PIN 5: blue</p>	<p>PIN 1: shield PIN 2: red PIN 3: black PIN 4: white PIN 5: blue</p>	<p>I II</p>	
Type	Female straight	Male straight	Female straight/Male straight
Supply voltage $U_b$	30 V	30 V	30 V
Number of conductors $\times$ conductor cross-section	2 $\times$ 24 AWG + 2 $\times$ 22 AWG	2 $\times$ 24 AWG + 2 $\times$ 22 AWG	2 $\times$ 24 AWG + 2 $\times$ 22 AWG
Degree of protection as per IEC 60529	IP 68	IP 68	IP 68
Ambient temperature $T_a$	-20...+80 °C	-20...+80 °C	-20...+80 °C

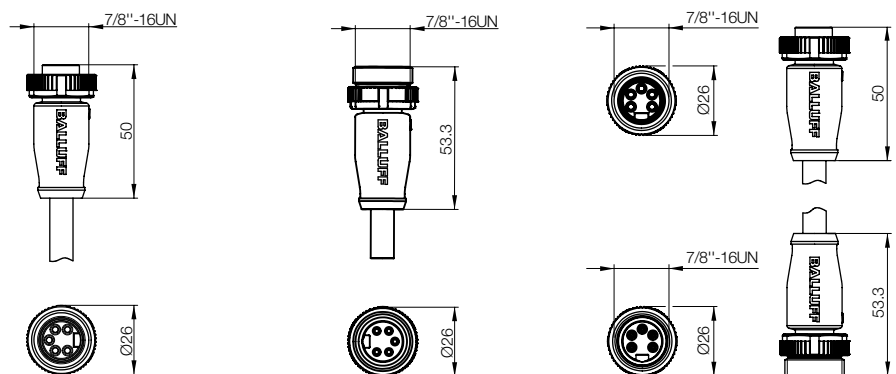

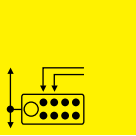

Standard lengths	Ordering code		
	Part number		
0.6 m			<b>BCC09YA</b> BCC A315-A315-30-330-VS85N6-006
2 m		<b>BCC09UY</b> BCC A315-0000-10-030-VS85N6-020	<b>BCC09W8</b> BCC A315-0000-20-030-VS85N6-020
5 m		<b>BCC09W0</b> BCC A315-0000-10-030-VS85N6-050	<b>BCC09WA</b> BCC A315-0000-20-030-VS85N6-050
10 m		<b>BCC09W3</b> BCC A315-0000-10-030-VS85N6-100	<b>BCC09WF</b> BCC A315-0000-20-030-VS85N6-100
15 m			<b>BCC09YJ</b> BCC A315-A315-30-330-VS85N6-020
			<b>BCC09YP</b> BCC A315-A315-30-330-VS85N6-050
			<b>BCC09YT</b> BCC A315-A315-30-330-VS85N6-100



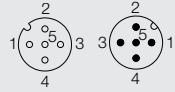

Profibus  
 Profinet  
 CC-Link  
 Devicenet  
 Product topology  
 IO-Link modules  
 Modules  
 Bitmaps  
 Power cables  
 Power tees  
 Power connectors  
**Bus cables**  
 Bus terminating resistor  
 Bus tee  
 Accessories  
 Analyzer  
 Ethernet/IP  
 Unmanaged switches

Connector diagram and wiring	 PIN 1: shield PIN 2: red PIN 3: black PIN 4: white PIN 5: blue	 PIN 1: shield PIN 2: red PIN 3: black PIN 4: white PIN 5: blue	 PIN 1: shield PIN 2: red PIN 3: black PIN 4: white PIN 5: blue
Type	Female straight	Male straight	Female straight/Male straight
Supply voltage $U_b$	30 V	30 V	30 V
Number of conductors × conductor cross-section	2×24 AWG + 2×22 AWG	2×24 AWG + 2×22 AWG	2×24 AWG + 2×22 AWG
Degree of protection as per IEC 60529	IP 68	IP 68	IP 68
Ambient temperature $T_a$	-20...+80 °C	-20...+80 °C	-20...+80 °C

Standard lengths	Ordering code		
	Part number		
0.6 m			<b>BCC0E03</b> BCC M415-M415-3A-330-VS85N6-006
2 m		<b>BCC0CZW</b> BCC M415-0000-1A-030-VS85N6-020	<b>BCC0E00</b> BCC M415-0000-2A-030-VS85N6-020
5 m		<b>BCC0CZY</b> BCC M415-0000-1A-030-VS85N6-050	<b>BCC0E01</b> BCC M415-0000-2A-030-VS85N6-050
10 m		<b>BCC0CZZ</b> BCC M415-0000-1A-030-VS85N6-100	<b>BCC0E02</b> BCC M415-0000-2A-030-VS85N6-100
15 m			<b>BCC0E07</b> BCC M415-M415-3A-330-VS85N6-150

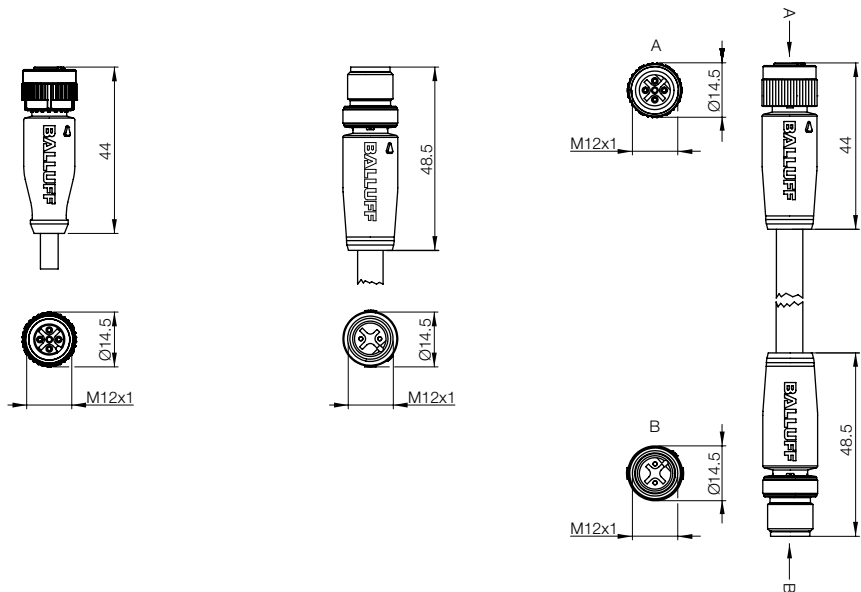

# Devicenet

## Power cables 7/8", 4-pin



Connector diagram and wiring	<p>PIN 1: brown PIN 2: white PIN 3: blue PIN 4: black</p>	<p>PIN 1: brown PIN 2: white PIN 3: blue PIN 4: black</p>
Type	Male	Male
Supply voltage $U_B$	300 V DC	300 V DC
Number of conductors × conductor cross-section	4×1.5 mm <sup>2</sup>	4×1.5 mm <sup>2</sup>
Degree of protection as per IEC 60529	IP 68	IP 68
Ambient temperature $T_a$	-25...+80° C	-25...+80° C

Cable material	Color	Length	Ordering code		
			Part number		
PUR		Black	2 m	<b>BCC06HL</b>	<b>BCC06HP</b>
				BCC A314-000-20-003-PX04A5-020	BCC A324-0000-20-003-PX04A5-020
PUR		Black	5 m	<b>BCC06HM</b>	<b>BCC06HR</b>
				BCC A314-000-20-003-PX04A5-050	BCC A324-0000-20-003-PX04A5-050
PUR		Black	10 m	<b>BCC06HN</b>	<b>BCC06HT</b>
				BCC A314-000-20-003-PX04A5-100	BCC A324-0000-20-003-PX04A5-100

Other cable materials, colors, and lengths on request.

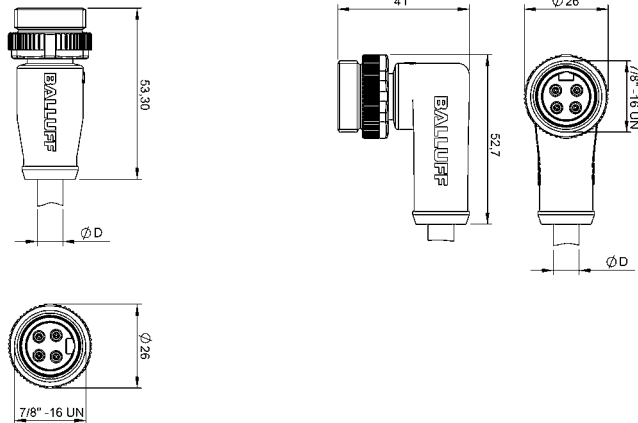

# Devicenet

## Power cables 7/8", 4-pin



Profibus  
 Profinet  
 CC-Link  
 Devicenet  
 Product topology  
 IO-Link modules  
 Modules  
 Bitmaps  
**Power cables**  
 Power tees  
 Power connectors  
 Bus cables  
 Bus terminating resistor  
 Bus tee  
 Accessories  
 Analyzer  
 Ethernet/IP  
 Unmanaged switches

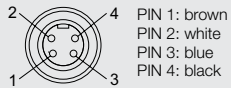

PIN 1: brown  
 PIN 2: white  
 PIN 3: blue  
 PIN 4: black



Female  
 300 V DC  
 4x1.5 mm<sup>2</sup>  
 IP 68  
 -25...+80° C

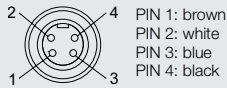

PIN 1: brown  
 PIN 2: white  
 PIN 3: blue  
 PIN 4: black



Female  
 300 V DC  
 4x1.5 mm<sup>2</sup>  
 IP 68  
 -25...+80° C

### Ordering code

Part number

#### BCC06HU

BCC A314-0000-10-003-PX04A5-020

#### BCC06HZ

BCC A324-0000-10-003-PX04A5-020

#### BCC06HW

BCC A314-0000-10-003-PX04A5-050

#### BCC06J0

BCC A324-0000-10-003-PX04A5-050

#### BCC06HY

BCC A314-0000-10-003-PX04A5-100

#### BCC06J1

BCC A324-0000-10-003-PX04A5-100

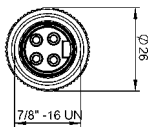
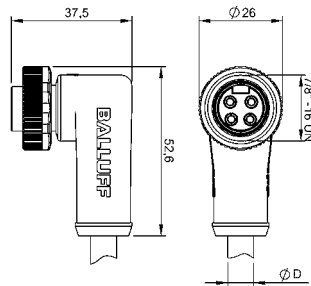
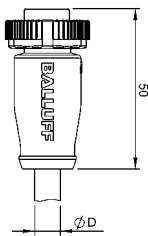

Power connection cables 7/8", 4-pin



Connector diagram and wiring	<p>PIN 1: brown PIN 2: white PIN 3: blue PIN 4: black</p>	<p>PIN 1: brown PIN 2: white PIN 3: blue PIN 4: black</p>
Type	Female/male	Female/male
Supply voltage $U_b$	300 V DC	300 V DC
Number of conductors $\times$ conductor cross-section	4 $\times$ 1.5 mm <sup>2</sup>	4 $\times$ 1.5 mm <sup>2</sup>
Degree of protection as per IEC 60529	IP 68	IP 68
Ambient temperature $T_a$	-25...+80° C	-25...+80° C

Cable material	Color	Length	Ordering code
PUR	Black	0.6 m	<b>BCC06J2</b> BCC A314-A314-30-304-PX04A5-006
PUR	Black	2 m	<b>BCC06J3</b> BCC A314-A314-30-304-PX04A5-020
PUR	Black	5 m	<b>BCC06J4</b> BCC A314-A314-30-304-PX04A5-050
PUR	Black	10 m	<b>BCC06J5</b> BCC A314-A314-30-304-PX04A5-100
PUR	Black	15 m	<b>BCC06J6</b> BCC A314-A314-30-304-PX04A5-150
			<b>BCC06J7</b> BCC A314-A324-30-304-PX04A5-006
			<b>BCC06J8</b> BCC A314-A324-30-304-PX04A5-020
			<b>BCC06J9</b> BCC A314-A324-30-304-PX04A5-050
			<b>BCC06JA</b> BCC A314-A324-30-304-PX04A5-100
			<b>BCC06JC</b> BCC A314-A324-30-304-PX04A5-150

Other cable materials, colors, and lengths on request.

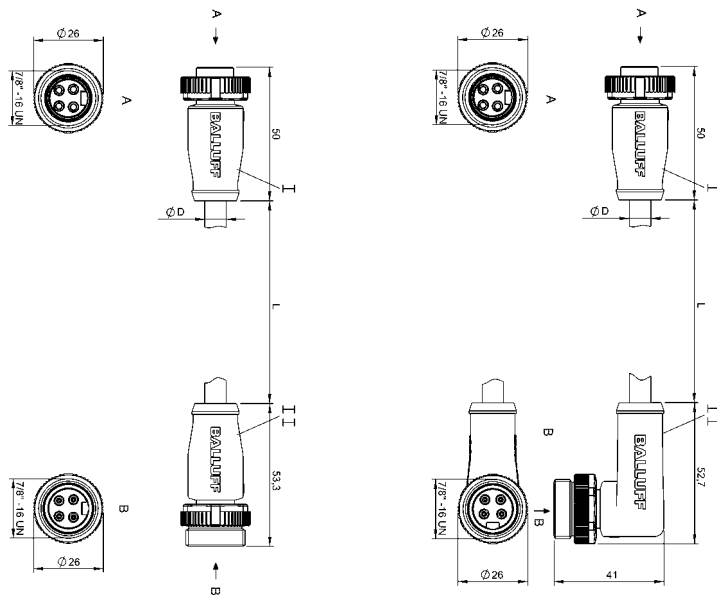

# Devicenet

## Power connection cables 7/8", 4-pin



- Profibus
- Profinet
- CC-Link
- Devicenet
- Product topology
- IO-Link modules
- Modules
- Bitmaps
- Power cables**
- Power tees
- Power connectors
- Bus cables
- Bus terminating resistor
- Bus tee
- Accessories
- Analyzer
- Ethernet/IP
- Unmanaged switches

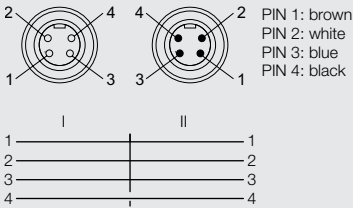

PIN 1: brown  
PIN 2: white  
PIN 3: blue  
PIN 4: black

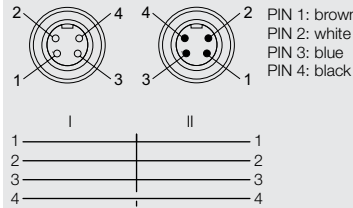

PIN 1: brown  
PIN 2: white  
PIN 3: blue  
PIN 4: black

Female/male  
300 V DC  
4x1.5 mm<sup>2</sup>  
IP 68  
-25...+80° C

Female/male  
300 V DC  
4x1.5 mm<sup>2</sup>  
IP 68  
-25...+80° C

### Ordering code

Part number

#### BCC06JE

BCC A324-A314-30-304-PX04A5-006

#### BCC06JL

BCC A324-A324-30-304-PX04A5-006

#### BCC06JF

BCC A324-A314-30-304-PX04A5-020

#### BCC06JM

BCC A324-A324-30-304-PX04A5-020

#### BCC06JH

BCC A324-A314-30-304-PX04A5-050

#### BCC06JN

BCC A324-A324-30-304-PX04A5-050

#### BCC06JJ

BCC A324-A314-30-304-PX04A5-100

#### BCC06JP

BCC A324-A324-30-304-PX04A5-100

#### BCC06JK

BCC A324-A314-30-304-PX04A5-150

#### BCC06JR

BCC A324-A324-30-304-PX04A5-150

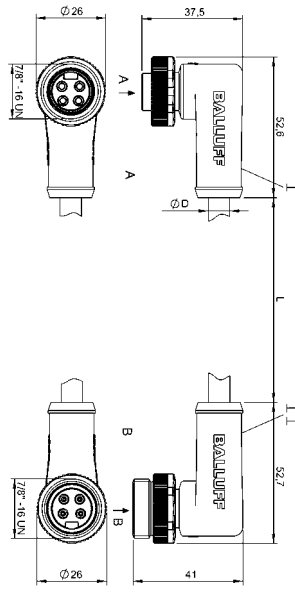
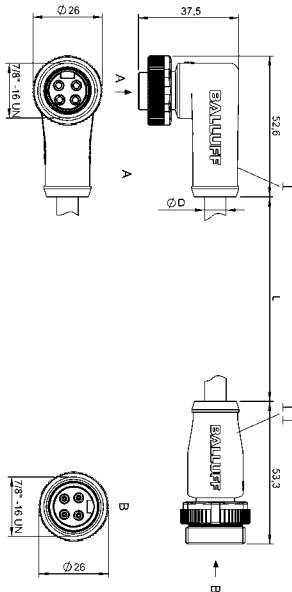



Connector diagram and wiring				
Configuration	Female mini size A 7/8"	Male mini size A 7/8"	Female M12	M12 plug
Version	Female standard	Male standard	Female	Male
Type	5-pin DN Mini female	5-pin DN Mini male	5-pin A-coded Micro female	5-pin A-coded Micro male
Without LED	<b>Ordering code</b> <b>BCC0A0A</b>	<b>BCC0A09</b>	<b>BCC0A08</b>	<b>BCC09MR</b>
Part number	BCC A315-0000-1A-R04	BCC A315-0000-2A-R04	BCC M415-0000-1A-R04	BCC M415-0000-2A-R04
Supply voltage $U_B$	50 V	50 V	10...30 V DC	50 V
Ambient temperature $T_a$	-25...+80 °C	-25...+80 °C	-40...+85 °C	-40...+85 °C
Degree of protection as per IEC 60529	IP 68	IP 68	IP 68	IP 68
Housing material	Plastic	Plastic	Plastic	Plastic

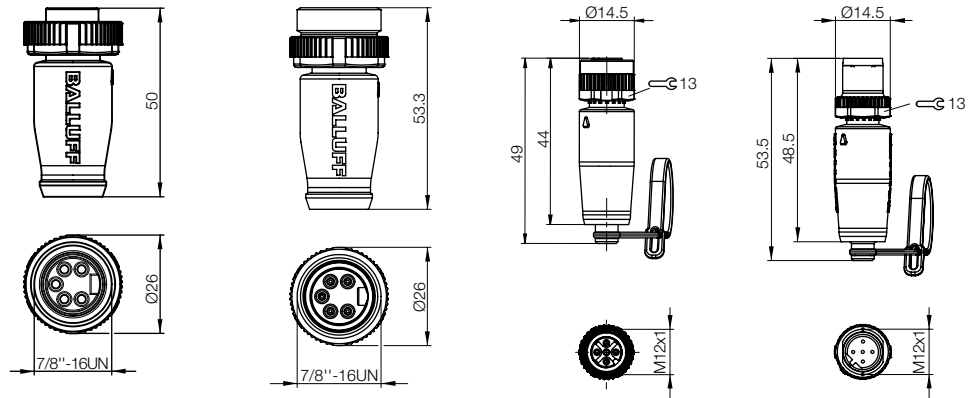

# Devicenet Bus tee



Profibus  
 Profinet  
 CC-Link  
 Devicenet  
 Product topology  
 IO-Link modules  
 Modules  
 Bitmaps  
 Power cables  
 Power tees  
 Power connectors  
 Bus cables  
**Bus terminating resistor**  
**Bus tee**  
 Accessories  
 Analyzer  
 Ethernet/IP  
 Unmanaged switches

Connector diagram and wiring		
Configuration	7/8" power distributor	
Version	Standard, 5-pin	
Type	Female/male	
<b>Ordering code</b>	<b>BCC0AA7</b>	
Part number	BCC A315-A315-A315-T0023-000	
Supply voltage $U_B$	300 V AC	
Degree of protection as per IEC 60529	IP 67	
Ambient temperature $T_a$	-40...+90 °C	
Housing material	Plastic	

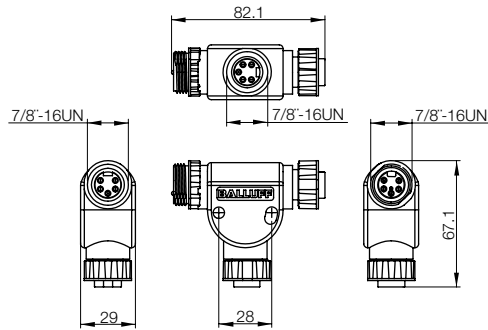





Connector diagram and wiring		
Configuration	7/8" power distributor Mini pass-thru, mini drop	
Version	Female/male, 4-pin mini size A 7/8"	
Type	Female/male	
<b>Ordering code</b>	<b>BCC0AA6</b>	
Part number	BCC A314-A314-A314-T0022-000	
Supply voltage $U_b$	50 V	
Degree of protection as per IEC 60529	IP 67	
Ambient temperature $T_a$	-20...+80 °C	
Housing material	TPE	

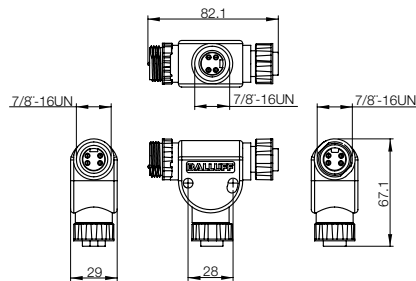

# Devicenet

## Power plug connector, 7/8", 4-pin



Profibus  
 Profinet  
 CC-Link  
 Devicenet  
 Product topology  
 IO-Link modules  
 Modules  
 Bitmaps  
 Power cables  
**Power tees**  
**Power connectors**  
 Bus cables  
 Bus terminating resistor  
 Bus tee  
 Accessories  
 Analyzer  
 Ethernet/IP  
 Unmanaged switches

Connector diagram and wiring		
Type	Female	Male
Supply voltage $U_B$	250 V	250 V
Number of conductors x conductor cross-section	4x max. 1.5 mm <sup>2</sup>	4x1.5 mm <sup>2</sup>
Degree of protection as per IEC 60529	IP 67	IP 67
Ambient temperature $T_a$	-25...+80 °C	-25...+80 °C

Cable material	Color	Ordering code	
Cable dia.		Part number	
PUR	Black	<b>BCC0706</b>	<b>BCC0709</b>
6...8 mm		BCC A334-0000-10-000-51X4A5-000	BCC A334-0000-20-000-51X4A5-000
PUR	Black	<b>BCC0707</b>	<b>BCC070A</b>
8...10 mm		BCC A334-0000-10-000-61X4A5-000	BCC A334-0000-20-000-61X4A5-000
PUR	Black	<b>BCC0708</b>	<b>BCC070C</b>
10...12 mm		BCC A334-0000-10-000-71X4A5-000	BCC A334-0000-20-000-71X4A5-000

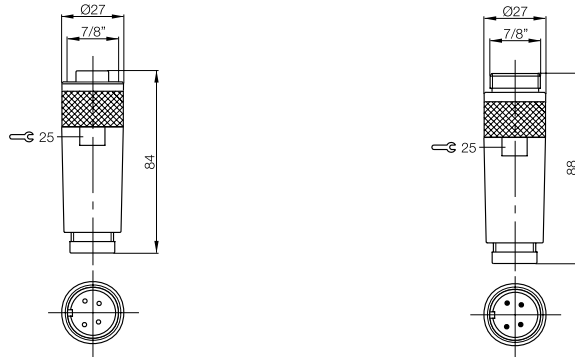



Connector diagram and wiring

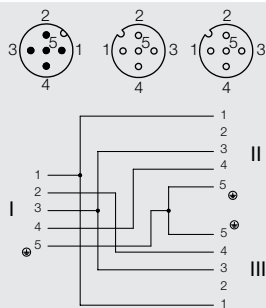

Description	T splitter	Screw plug 7/8"	Screw plug 7/8"
Use	2x M12 female to 1x M12 male	Cover for the power ports	Cover for the power ports
<b>Ordering code</b>	<b>BCC089P</b>	<b>BAM012T</b>	<b>BAM012U</b>
Part number	BCC M415-M415-M415-U0003-000	BKS-7/8-CS-00-A	BKS-7/8-CS-00-I
Supply voltage $U_b$	125 V		
Rated operating current $I_o$	4 A		
Degree of protection as per IEC 60529	IP 67		
Ambient temperature $T_a$	-25...+80 °C	-20...+80 °C	-20...+80 °C
Housing material	PA 6.6 + GF	Nickel-plated CuZn	Nickel-plated CuZn

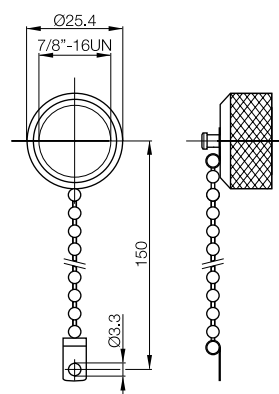
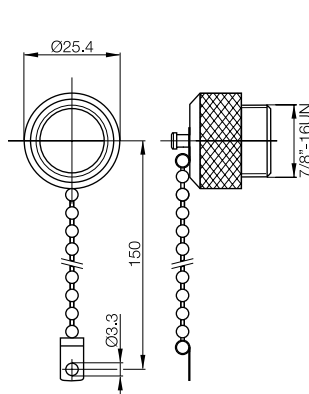
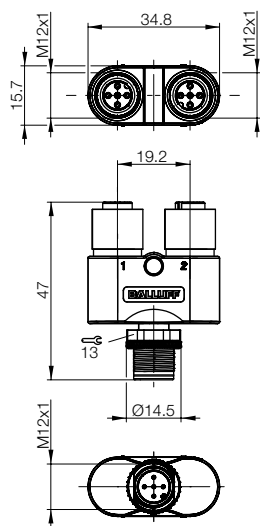

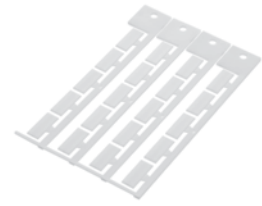

Profibus  
 Profinet  
 CC-Link  
 Devicenet  
 Product topology  
 IO-Link modules  
 Modules  
 Bitmaps  
 Power cables  
 Power tees  
 Power connectors  
 Bus cables  
 Bus terminating resistor  
 Bus tee  
**Accessories**  
 Analyzer  
 Ethernet/IP  
 Unmanaged switches

Description	M12 locking screw	Tamperproof cover with 4 openings	Marking sleeve	Label set
Use	IP 65 threaded cover for unused ports		For labeling connectors	Labeling the ports for modules BNI PBS..., BNI PNT..., BNI DNT..., BNI EIP..., BNI CCL...
<b>Ordering code</b>	<b>BAM01C2</b>	<b>BAM01J0</b>		<b>BAM01AT</b>
Part number	BAM CS-XA-002-M12-A	BAM FK-NI-PBS-01-C	BAM IA-CC-002-01	BNI ACC-L01-000
Ambient temperature T <sub>a</sub>	-20...+80 °C			
Housing material	Plastic			Plastic

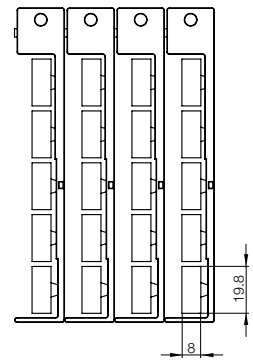
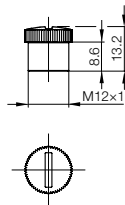



The Devicenet Analyzer is a particularly powerful tool for analyzing, commissioning, monitoring and maintaining Devicenet/CAN bus systems. The Devicenet tester was designed primarily for preventive maintenance purposes. Whether maintenance technicians, integrators or technical experts, anyone who requires reliable information on the functional status of their Devicenet system can use the Devicenet analyzer to increase the overall efficiency of their facility. On-site testing and analysis simplify your working day, increase reliability and save you time.

**Wiring test during commissioning**

The analyzer wiring test is able to detect defects and weak points such as incorrect cable types and lengths, short circuits, line breaks and faulty plug connections as early as the installation phase. Analysis of the bus physics before or during commissioning is another important feature. Every node can check the rate of change, signal-to-noise ratio and much more to enable the consistent identification of telegrams with a poor signal quality as well as the rapid identification of possible causes of the faults (such as missing/excess number of bus terminations, faulty bus drivers, bus or stub lines that are too long, etc.). Not only does this ensure that the specification is observed, but it also ensures optimum signal quality. The bus operates more reliably and, at the same time, is more resistant to EMC problems.

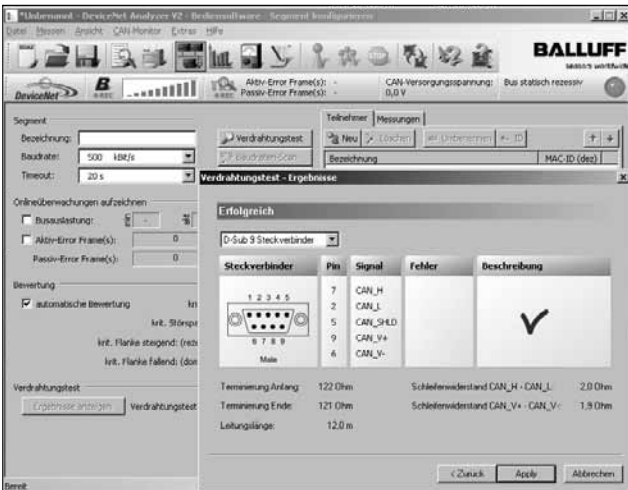

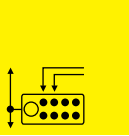

- Profibus
- Profinet
- CC-Link
- Devicenet
- Product topology
- IO-Link modules
- Modules
- Bitmaps
- Power cables
- Power tees
- Power connectors
- Bus cables
- Bus terminating resistor
- Bus tee
- Accessories
- Analyzer**
- Ethernet/IP
- Unmanaged switches

### Monitoring during ongoing operation

A comparison with previous measurements can be performed easily during operation, either at regular intervals or continuously via an online function. If required, the Devicenet analyzer saves all the measuring and report data for the installation being monitored. A gradual degradation of quality caused by cable wear, for example, can then no longer be overlooked. Preventive maintenance saves time and costs compared to a sudden system failure.

### Scope of delivery

The analyzer set in a durable case equips the user ideally for all eventualities. The device is equipped with a complete set of high-quality Devicenet accessories designed for harsh industrial use. The user can get started right away because all the necessary components such as adapters, adapter cables, tees and bus terminating resistors are already included. The analyzer also has a USB interface for connecting a PC or notebook. The device is very simple to operate thanks to the easy-to-use PC software.

### Devicenet/CAN analyzer

**BAE00C0**

BNI ACC A03-01-01

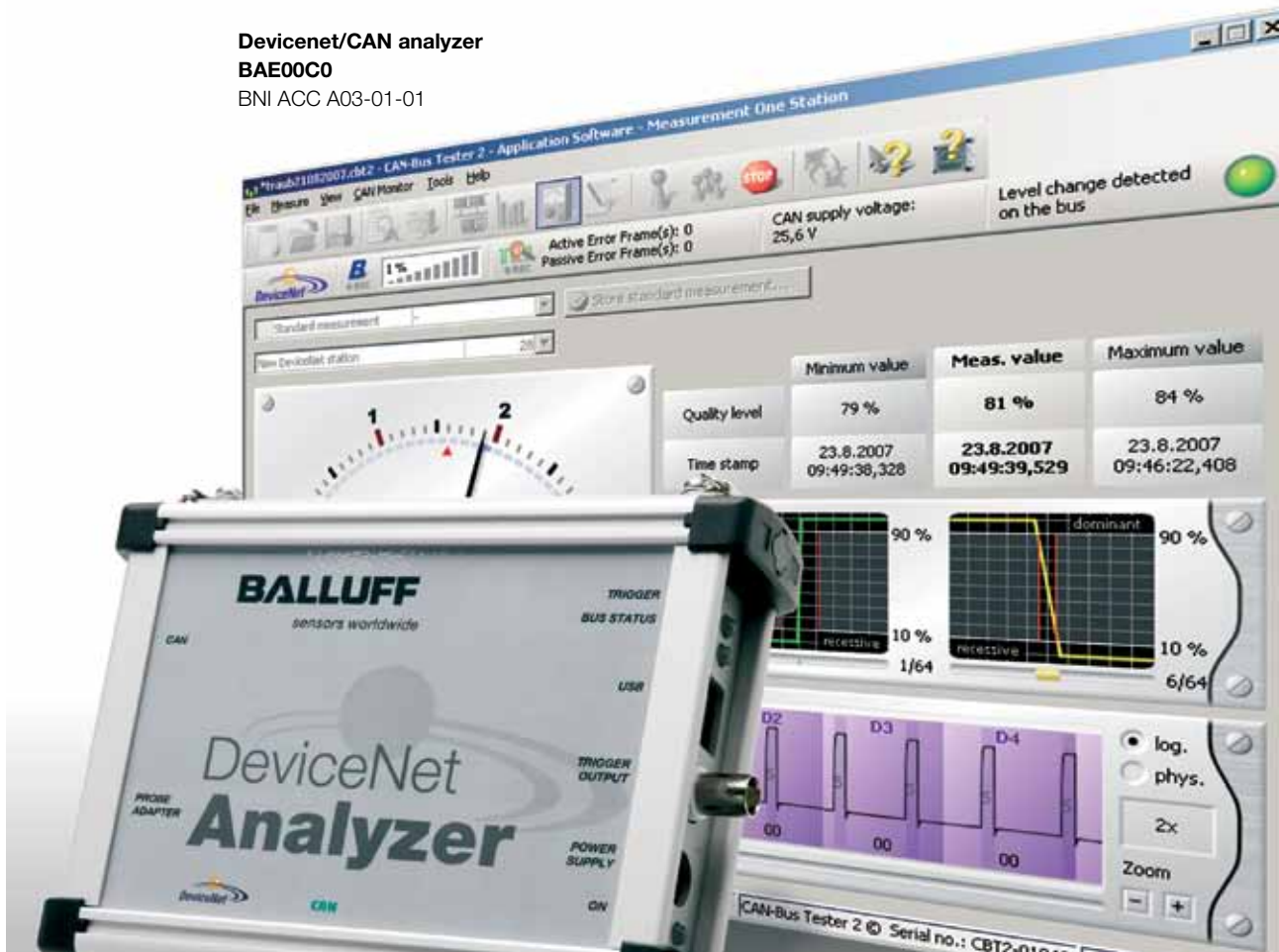



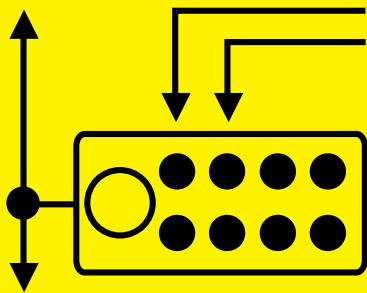

# Fieldbus Systems

## Fieldbus System: Ethernet/IP

In many areas, Ethernet/IP has replaced Devicenet and has become a globally recognized standard for network technology. Based on Ethernet, Ethernet/IP is considerably faster than Devicenet and facilitates the integration of drive technology. Furthermore, Ethernet/IP can be quickly installed and integrated in existing networks.

In addition to time savings and considerable cost savings, Balluff provides the added benefit of user-friendliness. Only our products can block IP addresses on Ethernet modules with a display and protect against accidental changes. As a result, you not only increase safety, but also simplify maintenance. The innovative address plug also guarantees simple exchange of modules.

Use the extensive line of Balluff Ethernet/IP products for your high-performance system. Because maximum efficiency is only possible with an optimized network.



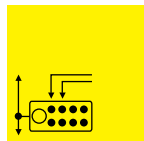

Product topology	96
IO-Link modules	102
Modules	103
Power tee	114
Power cables	116
Power connectors	120
Bus connection cables	106
Bus couplings	110
Bus connectors	112
Accessories	122
Bitmaps	124
Technical data	125
Display	126

**Shock and vibration**

- EN 60068-2-6 Vibration (sinusoidal)**
- EN 60068-2-27 Shocks**
- EN 60068-2-29 Continuous shocks**
- EN 60068-2-64 Broadband random noise**

**Approvals**







**Input**

- 16 or 32 PNP inputs
- Short-circuit protected
- Short-circuit diagnostics



**Input/output**

- 8 PNP inputs and 8 outputs or 16 PNP inputs and 16 outputs
- Short-circuit protected
- Short-circuit diagnostics
- Overload protection at point level
- Rated output current 2 A
- Overload diagnostics
- Resettable, latching overload diagnostics



**Output**

- 8 or 16 outputs
- Overload protection at point level
- Rated output current 2 A
- Overload diagnostics
- Resettable, latching overload diagnostics



**Unmanaged switches**

- Unmanaged switch with 9 ports
- Dual power sources
- 10/100 base Tx ports
- Supports half/full duplex
- Overload diagnostics
- M12 sockets, D-coded
- Store-and-forward technology

## Advantages of star topology

In industrial Ethernet networks, star topologies have prevailed over daisy chain topologies. Balluff offers star topologies exclusively due to their greater reliability.

**The advantages in detail**

- Elimination of the single point of failure on the I/O block and cable level
- Immediate segment notification for quickly locating errors
- Managed switches use IGMP snooping to increase the control efficiency of multicast traffic
- Managed switch functions are not available when integrating at the device level

At first glance, the daisy chain topology appears to save money. However, implementing this topology requires the installation of a switch in each I/O block. This increases the cost of each I/O block, even if not all blocks (e.g. the last in a chain) can use this function. Since dedicated switches are now affordable, compensating for the costs is irrelevant. All possible savings are also offset by technical disadvantages.

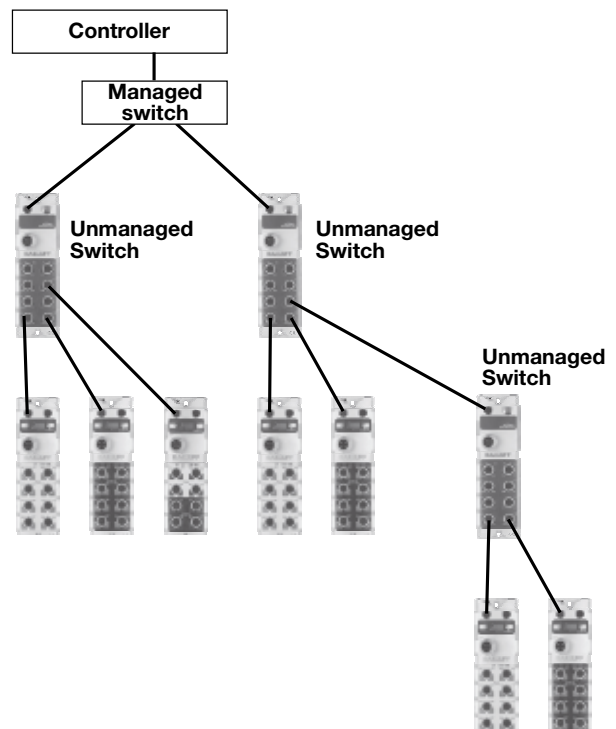

## Consistent communication all the way to the sensor

No other industrial network has seen the explosive level of growth experienced by Industrial Ethernet. Because communication from start to finish all the way to the sensor/actuator offers security. With the deterministic high-speed throughput and the proven reliability of the physical layer, Industrial Ethernet will continue to grow further in the coming years.

At Balluff, you will find a high-performance range of permanently mountable I/O blocks with compatible cables and accessory parts.

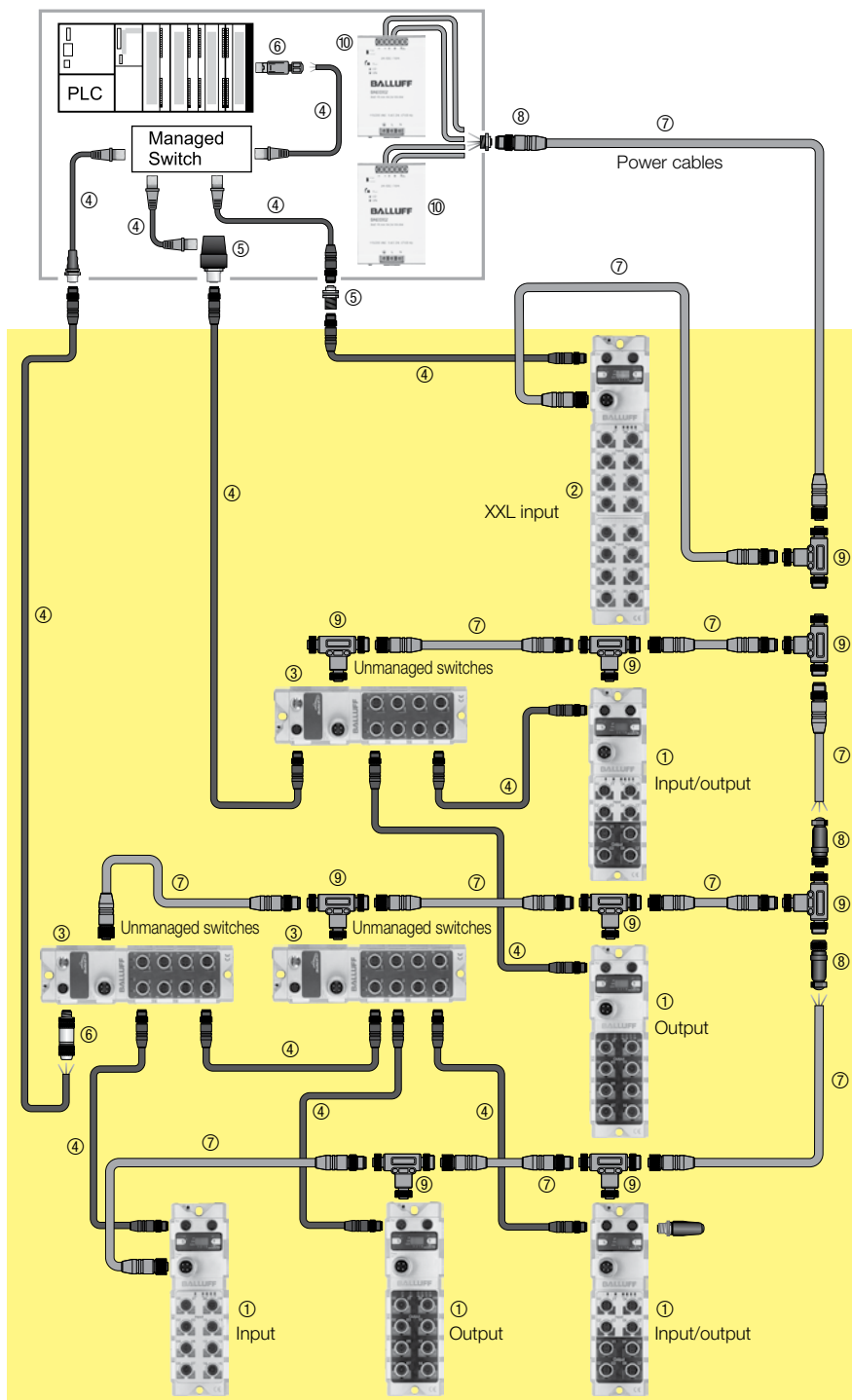

- ① **Ethernet/IP modules BNI**  
Page 102
- ② **Ethernet/IP XXL modules BNI**  
Page 104
- ④ **Bus cables BCC**  
Page 106
- ⑤ **Bus couplings and pass-thrus BCC**  
Page 110
- ⑥ **Field-attachable bus connectors BCC**  
Page 112
- ⑦ **Power cables BCC**  
Page 116
- ⑧ **Accessories BAM**  
Page 122
- ⑨ **Bus tees BCC**  
Page 114
- ⑩ **Power supplies BAE**  
Page 365



- Profibus
- Profinet
- CC-Link
- Devicenet
- Ethernet/IP
- Product topology**
- IO-Link modules
- Modules
- Power tee
- Power cables
- Power connectors
- Bus connection cables
- Bus couplings
- Bus connectors
- Accessories
- Bitmaps
- Technical data
- Display
- Unmanaged switches

## Integrated communication saves costs

Ethernet/IP has developed into a globally recognized standard for network technology that links field devices to centralized control solutions. Ethernet/IP can be quickly installed and integrated in existing networks.

Balluff Ethernet/IP comprises two versions of permanently mountable I/O blocks, unmanaged switches, network cables and accessories. At the heart of the extensive line of Balluff products are I/O blocks. They are characterized by low startup costs per point and are designed to save money through maximum system readiness and simple maintenance throughout the entire service life of the system.

### I/O-block network functions

- Simple, flexible IP addressing method
- BOOTP/DHCP
- IP 67 address plug (IPAP) for fast changes
- Addressable display (Series 100 only)
- Webserver interface
- Certified by ODVA to ensure reliable operation and full interoperability
- Operation with transfer rates of 10 Mbit/s and 100 Mbit/s for maximum throughput (automatic detection)
- Robust M12 Ethernet connection (D-coded)
- Supports star topology for increased reliability, exact troubleshooting and fast commissioning

### Clearly visible status LEDs

Low-quality LEDs that are often difficult to identify under demanding production conditions perform poorly when used in high-speed applications. Unlike Balluff status LEDs, which are large, bright, highly visible and provide maximum assistance. Balluff quality will help you complete setup and maintenance tasks and reduce machine downtimes with ease.

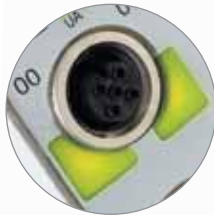

### Robust, full-metal housing

The fully encapsulated housing can withstand impacts, shaking, corrosive fluids, incorrect assembly as well as people stepping on it and costs the same as a plastic housing.

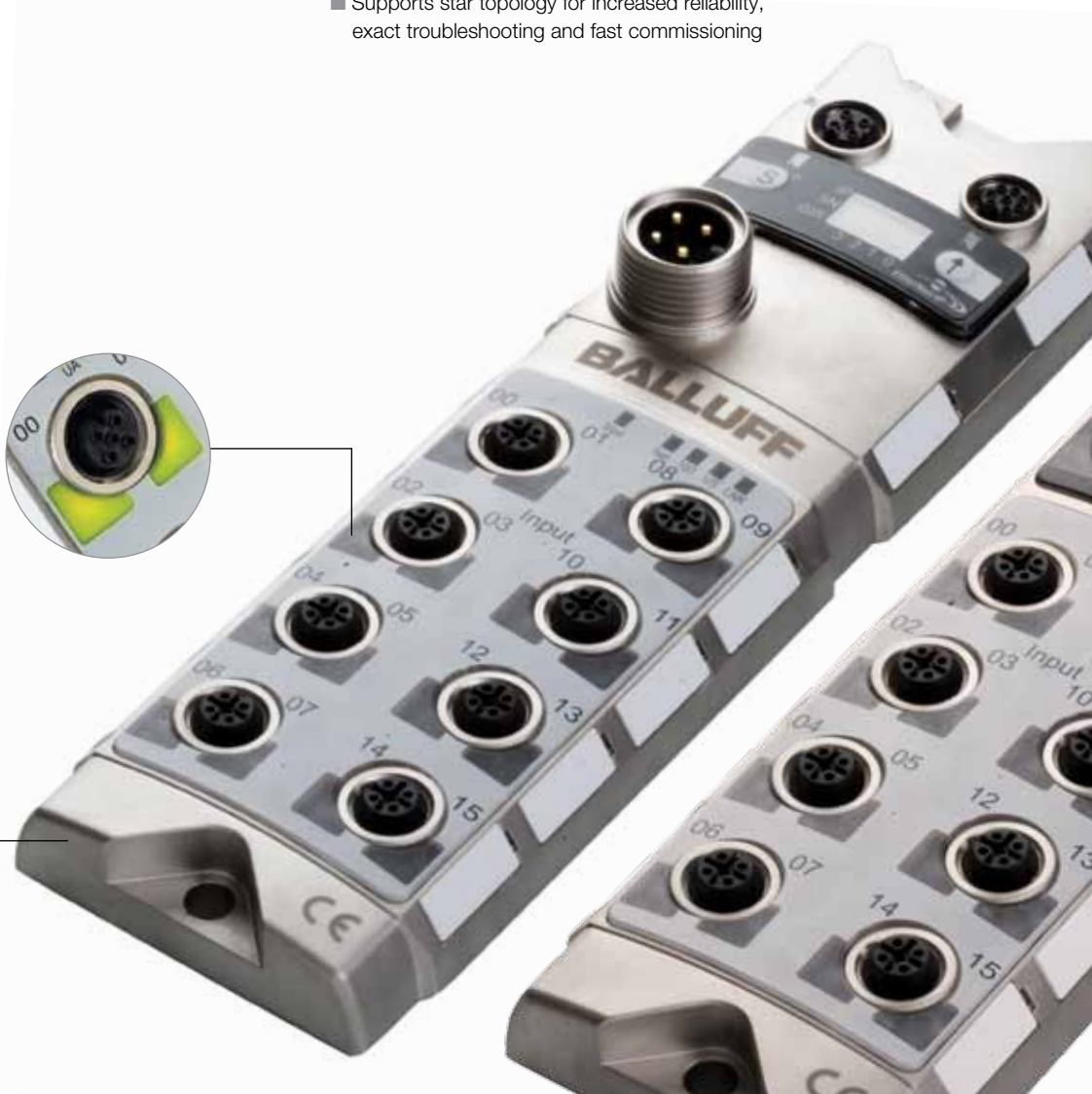

### Innovative housing design

The extra-flat profile reduces potential dangers posed by cables. Rounded corners offer highly visible locations for channel markers and two mounting points are sufficient to secure the robust metal housing.





- Profibus
- Profinet
- CC-Link
- Devicenet
- Ethernet/IP
- Product topology
- IO-Link modules
- Modules
- Power tee
- Power cables
- Power connectors
- Bus connection cables
- Bus couplings
- Bus connectors
- Accessories
- Bitmaps
- Technical data
- Display
- Unmanaged switches

### Powerful and safe outputs

With an output current of up to **2 amps**, Balluff output modules are capable of driving almost any load. Each output also offers an overload protection with LED indicator and a memory feature for easy troubleshooting.



### User-defined LEDs (100 series)

Like the IPAP, the display has red and green LEDs for simplifying possible troubleshooting.

### Addressable display (Series 100 only)

IP address, subnet mask and gateway address appear on the illuminated display. Push buttons can be used to set each octet of the addresses specified above. The display can be disabled via the PLC (controller).



## High-density XXL-I/O blocks reduce costs

High-density I/O blocks reduce per point costs because they consolidate communication hardware costs in a single unit. For example, if two 16-point input blocks are replaced by a 32-point input block, the cost for each point is reduced by 30% for the I/O blocks alone!

### More savings

- Switch utilization reduced by 13% – renders one port superfluous
- No network cable required
- Without auxiliary power cable
- 20% less installation space

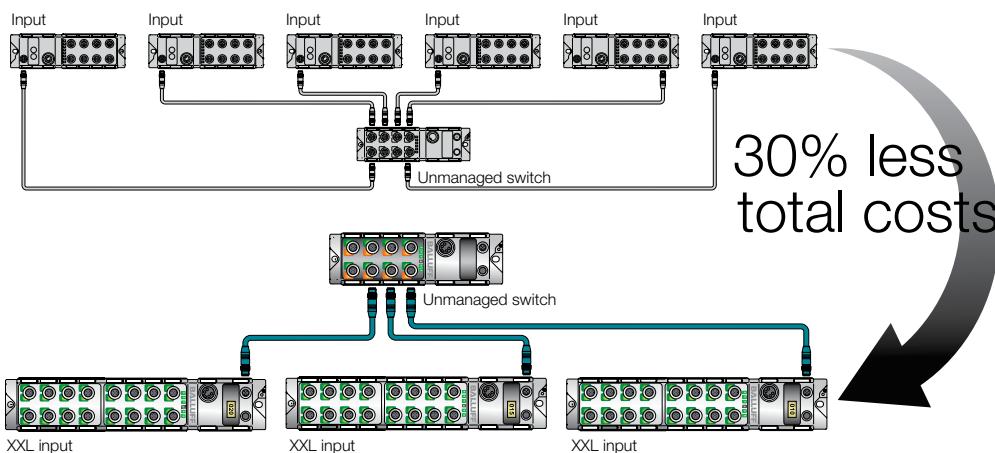





**Webserver**

For anyone that prefers a web interface, the Ethernet modules from Balluff have a simple integrated webserver. This web page can be used to program the module addresses and configure several of the user-defined functions.



A simple browser provides immediate access to the integrated webserver, which has been implemented in all Ethernet/IP modules of Gen IV.

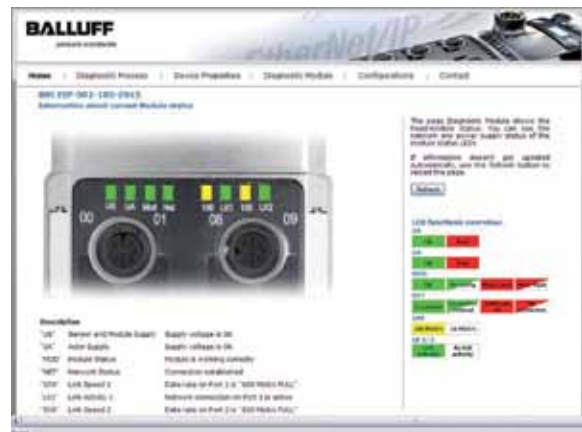

Extensive diagnostics functions are available here, such as displaying all module LEDs, including all representations in plain text.



In the "Device Properties" area you have the option, for example, of configuring devices connected to the IO-Link port.



The module configuration, such as assigning or displaying the IP address, is hidden behind the "Configurations" function.

### 136 IOs on a module

#### Balluff IO-Link solutions save cash money

Until now, at least nine fieldbus modules had to be used in order to be able to activate 136 IOs. Today, a single Profinet module is sufficient.

In connection with the extremely cost-effective sensor/actuator hubs from Balluff, now up to 136 IO signals are offered which can be processed in a most efficient manner. In this way, compared to the stan-

ard fieldbus modules, there is a high cost savings of 15 to 20% per input. If you add the savings from the fieldbus and power cables to that, you get 30 to 40%. A cost-effective M12 standard cable BCC is sufficient to switch on a sensor/actuator hub. Furthermore, sensor hubs need just one bus address, can variably group sensor signals together within an area of 20 m and ensure exceptional efficiency.

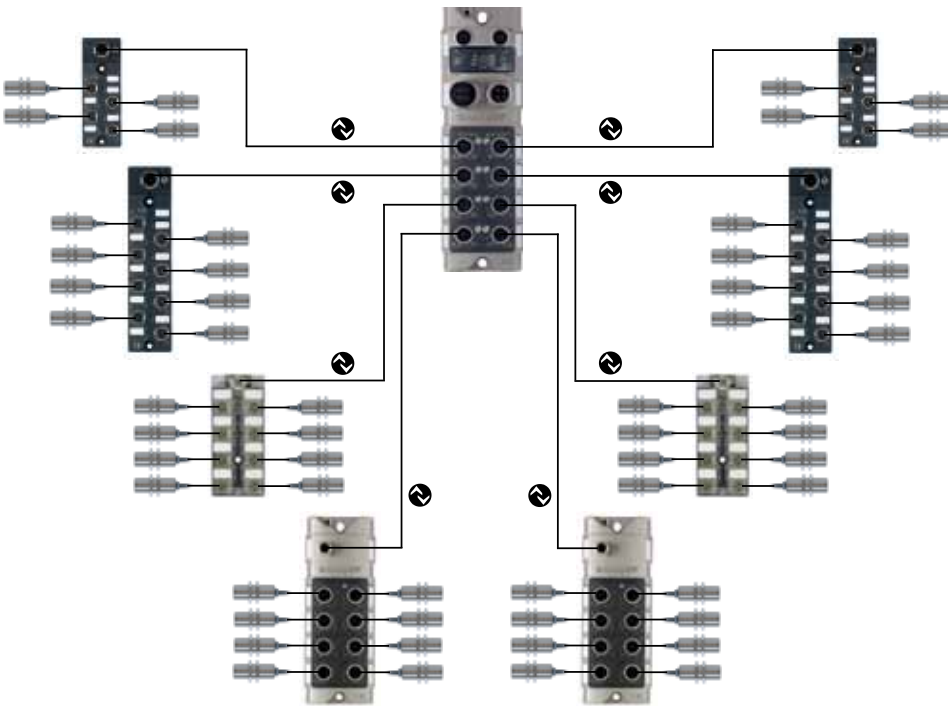

### 1000 tasks, one module:

#### The Ethernet module with eight IO-Link ports

Whether position measurement, object detection, identification, fluid sensor applications, temperature or pressure measurement: through IO-Link, the Ethernet module is suitable for every job.

IO-Link not only has advantages for installing standard sensors, but also can integrate intelligent devices via the same interface. With that, the module provides a uniform interface from the signal to the control level.

During field installation of intelligent devices, there are frequently high costs, as shielded cable and intelligent interface cards such as analog input cards are used in the controller. IO-Link not only makes error-prone analog inputs superfluous, it also reduces the wiring, inspection and hardware effort. With simple plug-and-play of unshielded, cost-effective M12 lines, the system is quickly and securely brought into operation.

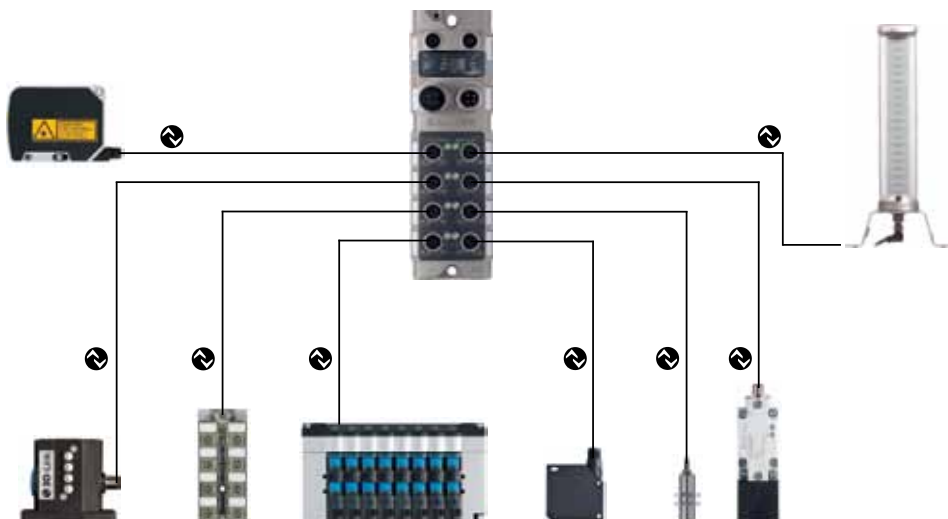

- Profibus
- Profinet
- CC-Link
- Devicenet
- Ethernet/IP
- Product topology
- IO-Link modules**
- Modules
- Power tee
- Power cables
- Power connectors
- Bus connection cables
- Bus couplings
- Bus connectors
- Accessories
- Bitmaps
- Technical data
- Display
- Unmanaged switch



## Ethernet/IP with IO-Link functionality

IO-Link does not just communicate with Profibus, Profinet and CC-Link now. At Balluff, IO-Link now communicates with Ethernet/IP so that all the benefits of IO-Link are available right down to the second lowest level.

IO-Link not only ensures freedom of installation, but also guarantees simplified wiring, integrated diagnostics and central configuration. System failures can be prevented more reliably and systems restarted quickly if a failure occurs.

Ethernet/IP with IO-Link guarantees efficient operation. Users gain time, save costs and incorporate intelligent connection technology to improve process quality.

The Ethernet/IP module with IO-Link includes four IO-Link master ports that can be configured and used fully independently of one another. This provides four additional, freely configurable standard I/O ports that offer a further eight inputs/outputs for standard sensors and actuators.



**IO-Link**



**IO-Link**

Fieldbus Version	Ethernet/IP 4x IO-Link, 16 DI/DO PNP	Ethernet/IP 8x IO-Link, 16 DI/DO PNP
<b>Ordering code</b>	<b>BNI004A</b>	<b>BNI006A</b>
Part number	BNI EIP-502-105-Z015	BNI EIP-508-105-Z015
Supply voltage $U_B$	18...30 V DC	18...30 V DC
Module current consumption	120...130 mA	120...130 mA
AUX input/output power status UA LED	US /no	US /no
Module status indicator: Mod LED	Yes	Yes
Network status indicator: Net LED	Yes	Yes
Port status indicator	Black, red, yellow	Black, red, yellow
Connection: Fieldbus	M12, D-coded, female	M12, D-coded, female
Connection: AUX power	7/8", male, 4-pin	7/8", male, 4-pin
Connection: I/O ports	M12, A-coded, female	M12, A-coded, female
No. of I/O ports	8	8
Number of inputs	max. 16 PNP	max. 16 PNP
Number of outputs	max. 16 PNP	max. 16 PNP
Configurable inputs/outputs	Yes	Yes
Max. load current, sensors/channel	200 mA	200 mA
Max. load current, output	1.6 A/2 A	1.6 A/2 A
Port status indicator (signal status)	Yellow LED	Yellow LED
Port diagnostic indicator (overload)	Red LED	Red LED
Total current $U_{Actuator}$	$\leq 9$ A	$\leq 9$ A
Total current $U_{Sensor}$	$\leq 9$ A	$\leq 9$ A
Degree of protection as per IEC 60529	IP 67 (when screwed into place)	IP 67 (when screwed into place)
Operating temperature $T_a$	-5...+70 °C	-5...+70 °C
Storage temperature	-25...+70 °C	-25...+70 °C
Fastener	2 mounting holes	2 mounting holes
Dimensions (LxWxH)	225x68x36.9 mm	225x68x36.9 mm
Housing material	Nickel-plated GdZn	Nickel-plated GdZn

### IO-Link Version 1.1

No. of IO-Link master ports	4x master	8x master
Operating modes (3-wire)	SIO, COM 1, COM 2, COM 3	SIO, COM 1, COM 2, COM 3
Indicators Communication	Green LED	Green LED
Error	Red LED	Red LED
Max. load current for IO-Link device	1.6 A	1.6 A

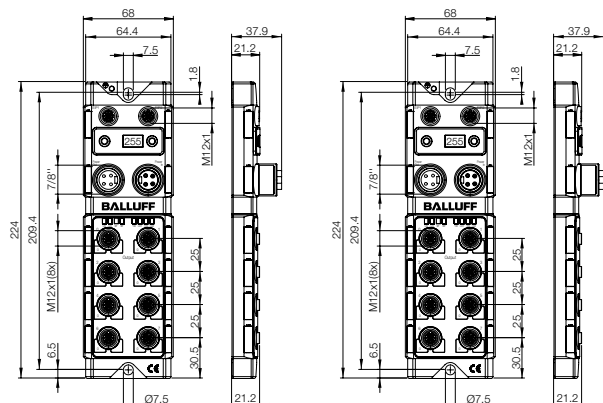

# Ethernet/IP Modules



Profibus  
Profinet  
CC-Link  
Devicenet  
Ethernet/IP

Product topology  
IO-Link modules  
Modules  
Power tee  
Power cables  
Power connectors  
Bus connection cables  
Bus couplings  
Bus connectors  
Accessories  
Bitmaps  
Technical data  
Display  
Unmanaged switch

Ethernet/IP	Ethernet/IP	Ethernet/IP	Ethernet/IP
16 DI/DO PNP configurable	16 DI PNP	8 DO PNP	8 DI/DO PNP configurable
<b>BNI004F</b>	<b>BNI004M</b>	<b>BNI005J</b>	<b>BNI0044</b>
BNI EIP-302-105-Z015	BNI EIP-104-105-Z015	BNI EIP-202-105-Z015	BNI EIP-307-100-Z014
18...30 V DC	18...30 V DC	18...30 V DC	18...30 V DC
120...130 mA	120...130 mA	BUS/RUN	120...130 mA
US /no	US /no	Display/pushbutton	US /no
Yes	Yes	Yes	Yes
Yes	Yes	Yes	Yes
Black, red, yellow	Black, red, yellow	Black, red, yellow	Black, red, yellow
M12, D-coded, female	M12, D-coded, female	M12, D-coded, female	M12, D-coded, female
7/8", male, 4-pin	7/8", male, 4-pin	7/8", male, 4-pin	7/8", male, 4-pin
M12, A-coded, female	M12, A-coded, female	M12, A-coded, female	M12, A-coded, female
8	8	8	4
max. 16 PNP	max. 16 PNP	8	max. 8 PNP
max. 16 PNP	No	No	max. 8 PNP
Yes	200 mA	200 mA	Yes
200 mA	200 mA	200 mA	200 mA
1.6 A/2 A	1.6 A/2 A	1.6 A/2 A	1.6 A/2 A
Yellow LED	Yellow LED	Yellow LED	Yellow LED
Red LED	Red LED	Red LED	Red LED
≤ 9 A	≤ 9 A	≤ 9 A	≤ 9 A
≤ 9 A	≤ 9 A	≤ 9 A	≤ 9 A
IP 67 (when screwed into place)	IP 67 (when screwed into place)	IP 67 (when screwed into place)	IP 67 (when screwed into place)
-5...+70 °C	-5...+70 °C	-5...+70 °C	-5...+70 °C
-25...+70 °C	-25...+70 °C	-25...+70 °C	-25...+70 °C
2 mounting holes	2 mounting holes	2 mounting holes	2 mounting holes
225×68×36.9 mm	225×68×36.9 mm	175×68×36.9 mm	175×68×36.9 mm
Nickel-plated GdZn	Nickel-plated GdZn	Nickel-plated GdZn	Nickel-plated GdZn

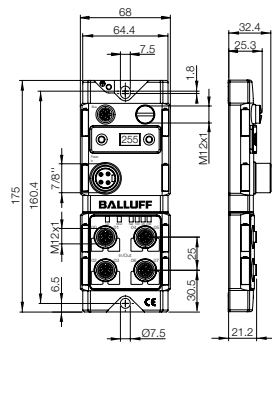
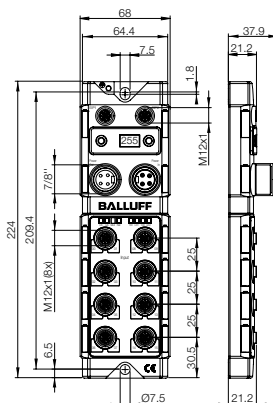
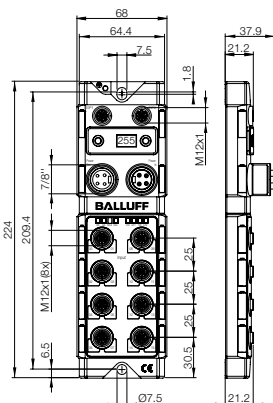
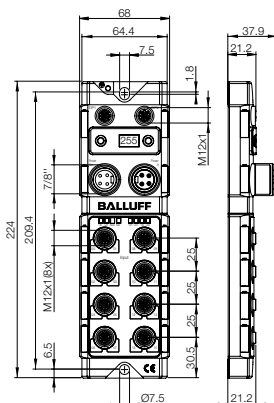





Type	16 DI	16 DI + 16 DO	32 DI
Display	Yes		Yes
<b>Ordering code</b>	<b>BNI0014</b>	<b>BNI0019</b>	<b>BNI0018</b>
Part number	BNI EIP-104-100-Z016	BNI EIP-306-100-Z010	BNI EIP-105-100-Z010
Supply voltage $U_B$	24 V DC	24 V DC	24 V DC
Module current consumption	120...130 mA	120...130 mA	120...130 mA
AUX input/output power status: $U_o$ LED	$U_T$ /no	Yes	$U_T$ /no
Module status indicator: Mod LED	Yes	Yes	Yes
Network status indicator:	Yes	Yes	Yes
Net LED			
Port status indicator	Black, red, yellow		Black, red, yellow
Connection: Fieldbus	M12, D-coded, female	M12, D-coded, female	M12, D-coded, female
Connection: AUX power	7/8", male, 4-pin	7/8", male, 4-pin	7/8", male, 4-pin
Connection: I/O ports	M12, A-coded, female	M12, A-coded, female	M12, A-coded, female
No. of I/O ports	8	16	16
Number of inputs	16 PNP	16 PNP	32 PNP
Number of outputs		16 PNP	
Max. load current, sensors/channel	200 mA	200 mA	200 mA
Max. load current actuators/channel		2 A	
Sensor total current $U_{Sensor}$	9 A	9 A	9 A
Actuator total current/ $U_{Actuator}$		9 A	
Degree of protection	IP 67	IP 67	IP 67
Operating temperature	-5...+55 °C	-5...+55 °C	-5...+55 °C
Storage temperature	-25...+70 °C	-25...+70 °C	-25...+70 °C
Housing material	Nickel-plated GdZn	Nickel-plated GdZn	Nickel-plated GdZn
Transfer rates			
IP address space	IPv4	IPv4	IPv4
Addressing methods	BOOTP, DHCP, IP address plug, USB tool, function block, display	BOOTP, DHCP, IP address plug, USB tool, function block, display	BOOTP, DHCP, IP address plug, USB tool, function block, display
Max. switching frequency	100 Hz ohm active load, 1...10 Hz inductive load		
Outputs can be reset using software		Yes	
Overload protection		Yes	
Short-circuit protected	Yes	Yes	Yes
Input/output type	PNP inputs	PNP	PNP inputs
Approvals	ODVA, UL-CUL, CSA, CE	ODVA, UL-CUL, CSA, CE	ODVA, UL-CUL, CSA, CE

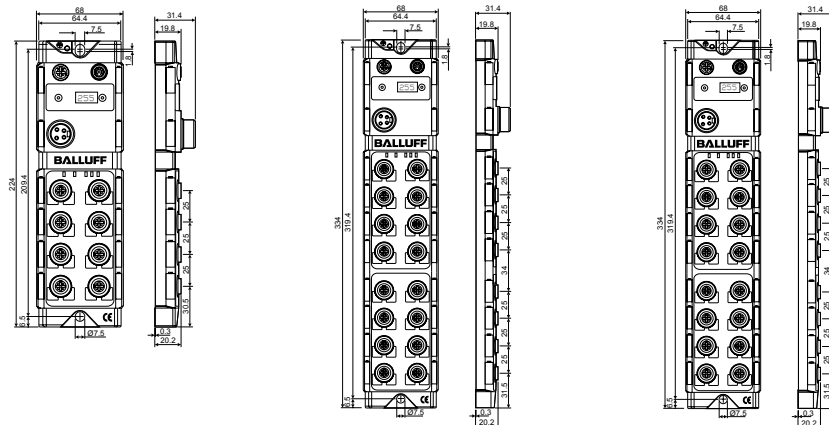

All modules include four screw plugs and a label set.

# Ethernet/IP Modules



IP-  
SN-  
GW-  
3 2 1 0



IP-  
SN-  
GW-  
3 2 1 0



IP-  
SN-  
GW-  
3 2 1 0

	8 DO	16 DO	8 DI + 8 DO	
	Yes	Yes	Yes	
	<b>BNI0015</b>	<b>BNI0016</b>	<b>BNI0017</b>	
	BNI EIP-202-100-Z016	BNI EIP-206-100-Z016	BNI EIP-305-100-Z016	
	24 V DC	24 V DC	24 V DC	
	120...130 mA	120...130 mA	120...130 mA	
	Yes	Yes	Yes	
	Yes	Yes	Yes	
	Yes	Yes	Yes	
	Black, red, yellow	Black, red, yellow	Black, red, yellow	
	M12, D-coded, female	M12, D-coded, female	M12, D-coded, female	
	7/8", male, 4-pin	7/8", male, 4-pin	7/8", male, 4-pin	
	M12, A-coded, female	M12, A-coded, female	M12, A-coded, female	
	8	8	8	
	8 PNP	16 PNP	8 PNP	
	2 A	2 A	2 A	
	9 A	9 A	9 A	
	9 A	9 A	9 A	
	IP 67	IP 67	IP 67	
	-5...+55 °C	-5...+55 °C	-5...+55 °C	
	-25...+70 °C	-25...+70 °C	-25...+70 °C	
	Nickel-plated GdZn	Nickel-plated GdZn	Nickel-plated GdZn	
	10/100 Mbps, automatic detection, full-duplex	10/100 Mbps, automatic detection, full-duplex	10/100 Mbps, automatic detection, full-duplex	
	IPv4	IPv4	IPv4	
	BOOTP, DHCP, IP address plug, USB tool, function block, display	BOOTP, DHCP, IP address plug, USB tool, function block, display	BOOTP, DHCP, IP address plug, USB tool, function block, display	
	100 Hz ohm active load, 1...10 Hz inductive load			
	Yes	Yes	Yes	
	Yes	Yes	Yes	
	Outputs	Outputs	PNP inputs/outputs	
	ODVA, UL-CUL, CSA, CE	ODVA, UL-CUL, CSA, CE	ODVA, UL-CUL, CSA, CE	



Profibus  
Profinet  
CC-Link  
Devicenet  
Ethernet/IP

Product topology  
IO-Link modules  
**Modules**  
Power tee  
Power cables  
Power connectors  
Bus connection cables  
Bus couplings  
Bus connectors  
Accessories  
Bitmaps  
Technical data  
Display  
Unmanaged switch

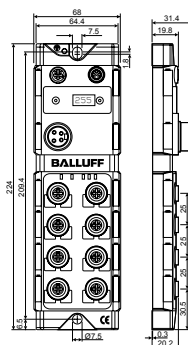
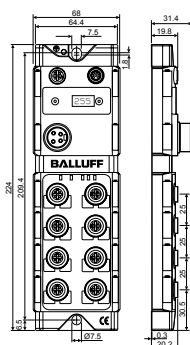
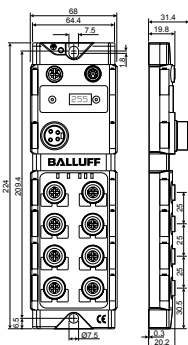

# Ethernet/IP

## M12 bus connection cable, shielded



Connector diagram and wiring	
Type	M12 male straight/M12 male straight
Supply voltage $U_b$	250 V AC/DC
Number of conductors $\times$ conductor cross-section	2 $\times$ 2 $\times$ 24 AWG
Degree of protection as per IEC 60529	IP 67
Ambient temperature $T_a$	-25...+75 °C

Cable material	Color	Length	Ordering code
TPE shielded	blue-green	0.6 m	Part number <b>BCC09NL</b>
TPE shielded	blue-green	2 m	BCC M414-M414-6D-338-ES64N9-006
TPE shielded	blue-green	5 m	<b>BCC09NN</b> BCC M414-M414-6D-338-ES64N9-020
TPE shielded	blue-green	10 m	<b>BCC09NP</b> BCC M414-M414-6D-338-ES64N9-050
TPE shielded	blue-green	15 m	<b>BCC09NR</b> BCC M414-M414-6D-338-ES64N9-100
TPE shielded	blue-green	15 m	<b>BCC09NT</b> BCC M414-M414-6D-338-ES64N9-150

Other cable materials, colors and lengths on request.

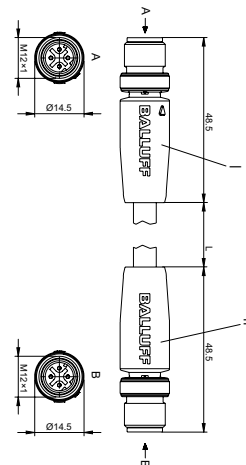

# Ethernet/IP

## M12 and RJ45 bus connection cables, shielded

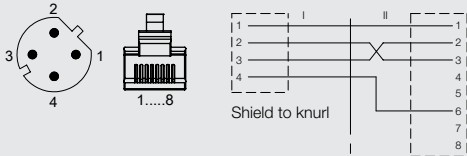
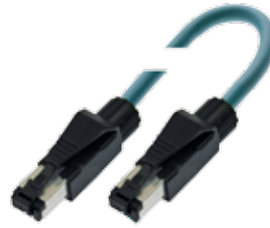

- Profibus
- Profinet
- CC-Link
- Devicenet
- Ethernet/IP
- Product topology
- IO-Link modules
- Modules
- Power tee
- Power cables
- Power connectors
- Bus connection cable**
- Bus couplings
- Bus connectors
- Accessories
- Bitmaps
- Technical data
- Display
- Unmanaged switch

M12 male straight/RJ45 male straight  
 60 V AC/DC  
 2x2x24 AWG  
 IP 67/IP 20  
 -25...+70 °C

RJ45 male straight/RJ45 male straight  
 60 V AC/DC  
 2x2x24 AWG  
 IP 20/IP 20  
 -25...+70 °C

Ordering code	
Part number	
<b>BCC0CZA</b>	<b>BCC0CZJ</b>
BCC M414-E834-8G-672-ES64N9-006	BCC E834-E834-90-339-ES64N9-006
<b>BCC0CZC</b>	<b>BCC0CZK</b>
BCC M414-E834-8G-672-ES64N9-020	BCC E834-E834-90-339-ES64N9-020
<b>BCC0CZE</b>	<b>BCC0CZL</b>
BCC M414-E834-8G-672-ES64N9-050	BCC E834-E834-90-339-ES64N9-050
<b>BCC0CFZ</b>	<b>BCC0CZM</b>
BCC M414-E834-8G-672-ES64N9-100	BCC E834-E834-90-339-ES64N9-100
<b>BCC0CZH</b>	<b>BCC0CZN</b>
BCC M414-E834-8G-672-ES64N9-150	BCC E834-E834-90-339-ES64N9-150

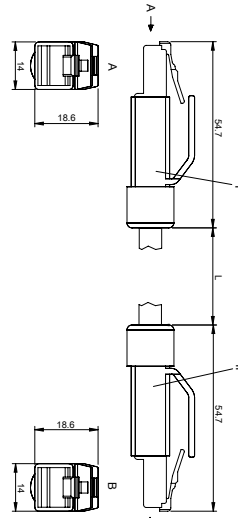
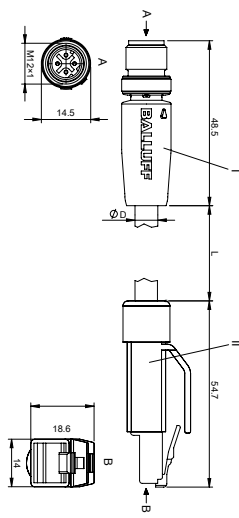

Ethernet/IP  
**M12 bus connection cable,  
 unshielded**



Connector diagram and wiring	
Type	M12 male straight/M12 male straight
Supply voltage $U_b$	60 V AC/DC
Number of conductors $\times$ conductor cross-section	2 $\times$ 2 $\times$ 24 AWG
Degree of protection as per IEC 60529	IP 67
Ambient temperature $T_a$	-40...+75 °C

Cable material	Color	Length	Ordering code
TPE unshielded	blue-green	0.6 m	Part number <b>BCC0E08</b> BCC M414-M414-6D-366-EX64N9-006
TPE unshielded	blue-green	2 m	<b>BCC0CLZ</b> BCC M414-M414-6D-366-EX64N9-020
TPE unshielded	blue-green	5 m	<b>BCC0CM1</b> BCC M414-M414-6D-366-EX64N9-050
TPE unshielded	blue-green	10 m	<b>BCC0CM3</b> BCC M414-M414-6D-366-EX64N9-100
TPE unshielded	blue-green	15 m	<b>BCC0E09</b> BCC M414-M414-6D-366-EX64N9-150

Other cable materials, colors and lengths on request.

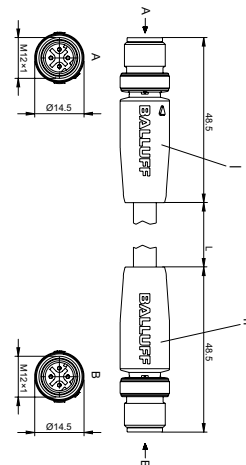

# Ethernet/IP

## M12 and RJ45 bus connection cables, unshielded

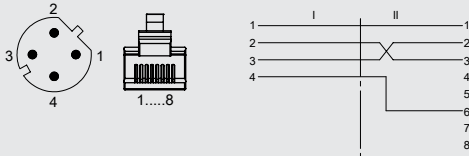
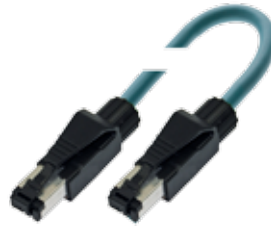

M12 male straight/RJ45 male straight  
60 V AC/DC  
2×2×24 AWG  
IP 67/IP 20  
-40...+70 °C



RJ45 male straight/RJ45 male straight  
60 V AC/DC  
2×2×24 AWG  
IP 20/IP 20  
-40...+70 °C

### Ordering code

Part number

#### BCC0E0A

BCC M414-E834-8G-695-EX64N9-006

#### BCC0E0C

BCC M414-E834-8G-695-EX64N9-020

#### BCC0CNP

BCC M414-E834-8G-695-EX64N9-050

#### BCC0CNR

BCC M414-E834-8G-695-EX64N9-100

#### BCC0CNT

BCC M414-E834-8G-695-EX64N9-150

#### BCC0CZP

BCC E834-E834-90-367-EX64N9-006

#### BCC0CZR

BCC E834-E834-90-367-EX64N9-020

#### BCC0CZT

BCC E834-E834-90-367-EX64N9-050

#### BCC0CZU

BCC E834-E834-90-367-EX64N9-100

#### BCC0CZU

BCC E834-E834-90-367-EX64N9-150

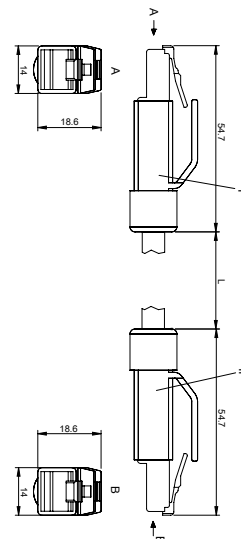
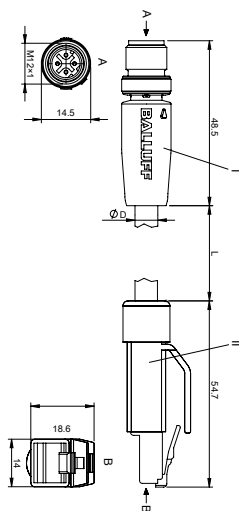

Profibus  
Profinet  
CC-Link  
Devicenet  
Ethernet/IP

Product topology  
IO-Link modules  
Modules  
Power tee  
Power cables  
Power connectors

**Bus connection cable**  
Bus couplings  
Bus connectors  
Accessories  
Bitmaps  
Technical data  
Display  
Unmanaged switch



Connector diagram and wiring		
Type	M12 female straight/RJ45 straight, pass-thru	M12 female straight/RJ45 right angle, pass-thru
Coding	D-coded/no coding	D-coded/no coding
Supply voltage $U_b$	60 V AC/DC	60 V AC/DC
Degree of protection	IP 20	IP 20
Ambient temperature $T_a$	-25...+85 °C	-25...+85 °C
Mounting thread	M16	M16

Ordering code	
Part number	
<b>BCC085F</b>	<b>BCC085H</b>
BCC M414-E814-BG-RM013-000	BCC M424-E814-BG-RM013-000

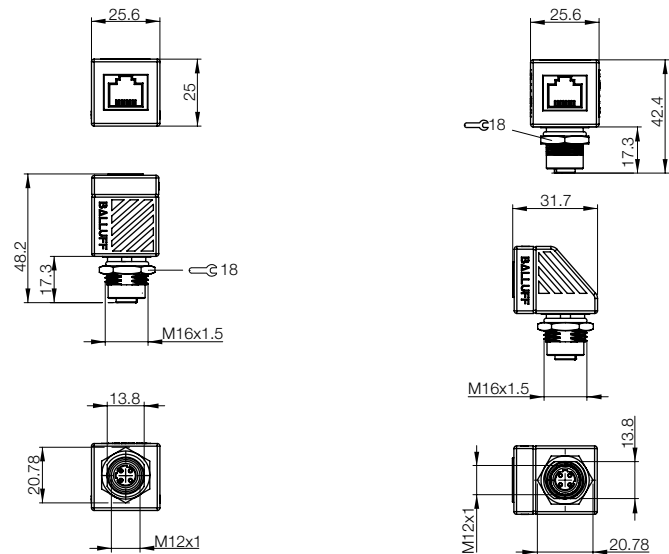

# Ethernet/IP

## Bus couplings and pass-thrus



- Profibus
- Profinet
- CC-Link
- Devicenet
- Ethernet/IP
- Product topology
- IO-Link modules
- Modules
- Power tee
- Power cables
- Power connectors
- Bus connection cable
- Bus couplings**
- Bus connectors
- Accessories
- Bitmaps
- Technical data
- Display
- Unmanaged switch

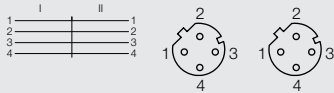

M12 female straight/M12 female straight,  
pass-thru  
D-coded  
60 V AC/DC  
IP 67  
-25...+80 °C  
M16

### Ordering code

Part number

**BCC06YP**

BCC M454-M454-5D-RM002-000

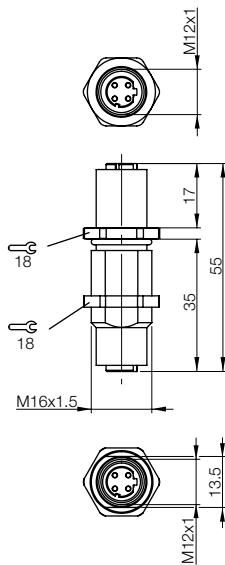



**Bus connector M12, 4-pin, D-coded,  
User-fabricated, shieldable**

Connector diagram and wiring			
Connector	M12 male, straight	M12 male, right-angle	
Version	4-pin, D-coded	4-pin, D-coded	
<b>Ordering code</b>	<b>BCC03WZ</b>	<b>BCC03Y0</b>	
Part number	BCC M474-0000-2D-000-51X475-000	BCC M484-0000-2D-000-51X475-000	
Nominal voltage	60 V AC/DC	60 V AC/DC	
Number of connections	4	4	
Number of conductors × Cross-section	4×0.75 mm <sup>2</sup>	4×0.75 mm <sup>2</sup>	
Cable diameter	Max. 8 mm	Max. 8 mm	
Connection	Cage clamp	Screw plug	
Degree of protection as per IEC 60529	IP 67	IP 67	
Ambient temperature T <sub>a</sub>	-25...+85 °C	-25...+85 °C	
Housing material	CuZn	CuZn	
Shielded design	Yes	Yes	

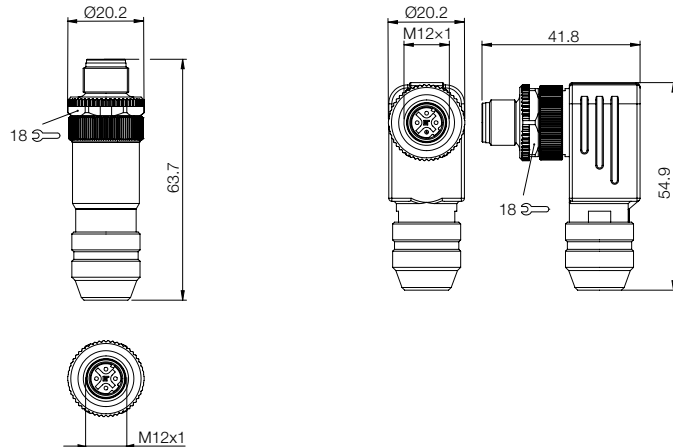

# Ethernet/IP

## Bus connector M12, 4-pin, D-coded, User-fabricated, shieldable



Profibus  
Profinet  
CC-Link  
Devicenet  
Ethernet/IP

Product topology  
IO-Link modules  
Modules  
Power tee  
Power cables  
Power connectors  
Bus connection cable  
Bus couplings  
**Bus connectors**  
Accessories  
Bitmaps  
Technical data  
Display  
Unmanaged switch

M12 female, straight 4-pin, D-coded	M12 female, right-angle 4-pin, D-coded	RJ45 male, straight No coding
<b>BCC03Y1</b> BCC M474-0000-1D-000-51X475-000	<b>BCC03Y2</b> BCC M484-0000-1D-000-51X475-000	<b>BCC06FH</b> BCC E834-0000-20-000-53X4T2-000
60 V AC/DC 4 4x0.75 mm <sup>2</sup>	60 V AC/DC 4 4x0.75 mm <sup>2</sup>	60 V AC/DC 4 244x max. AWG 22
Max. 8 mm Cage clamp IP 67 -25...+85 °C CuZn Yes	Max. 8 mm Screw plug IP 67 -25...+85 °C CuZn Yes	Max. 9 mm Insulation displacement connector technology IP 20 -40...+70 °C Yes

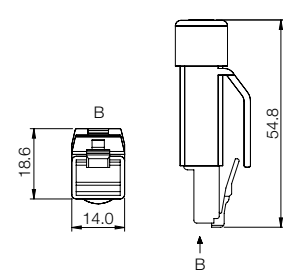
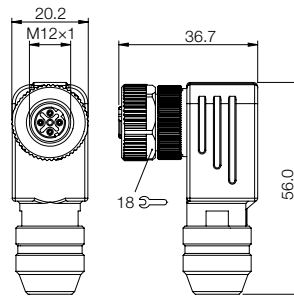
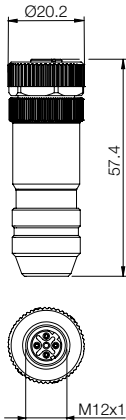

# Ethernet/IP

## Power tee, 7/8", 4-pin



Connector diagram and wiring		
Configuration	7/8" power distributor Mini pass-thru, mini drop	
Version	Female/male, 4-pin mini size A 7/8"	
Type	Female/male	
<b>Ordering code</b>	<b>BCC0AA6</b>	
Part number	BCC A314-A314-A314-T0022-000	
Supply voltage $U_b$	50 V	
Degree of protection as per IEC 60529	IP 67	
Ambient temperature $T_a$	-20...+80 °C	
Housing material	TPE	

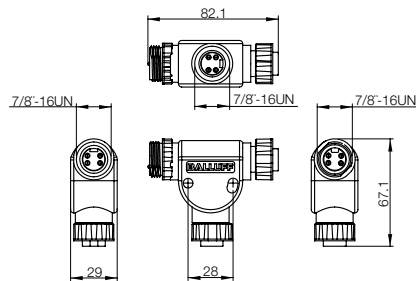



- Profibus
- Profinet
- CC-Link
- Devicenet
- Ethernet/IP
- Product topology
- IO-Link modules
- Modules
- Power tee**
- Power cables
- Power connectors
- Bus connection cable
- Bus couplings
- Bus connectors
- Accessories
- Bitmaps
- Technical data
- Display
- Unmanaged switch

# Ethernet/IP

## Power cables 7/8", 4-pin

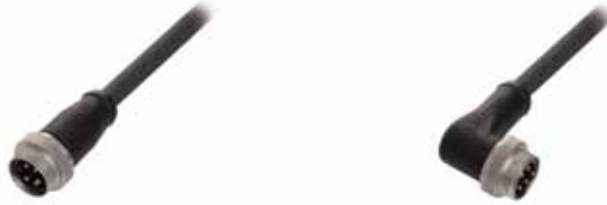

Connector diagram and wiring	<p>PIN 1: brown PIN 2: white PIN 3: blue PIN 4: black</p>	<p>PIN 1: brown PIN 2: white PIN 3: blue PIN 4: black</p>
Type	Male	Male
Supply voltage $U_B$	300 V DC	300 V DC
Number of conductors × conductor cross-section	4×1.5 mm <sup>2</sup>	4×1.5 mm <sup>2</sup>
Degree of protection as per IEC 60529	IP 68	IP 68
Ambient temperature $T_a$	-25...+80° C	-25...+80° C

Cable material	Color	Length	Ordering code		
			Part number		
PUR		Black	2 m	<b>BCC06HL</b>	<b>BCC06HP</b>
				BCC A314-000-20-003-PX04A5-020	BCC A324-0000-20-003-PX04A5-020
PUR		Black	5 m	<b>BCC06HM</b>	<b>BCC06HR</b>
				BCC A314-000-20-003-PX04A5-050	BCC A324-0000-20-003-PX04A5-050
PUR		Black	10 m	<b>BCC06HN</b>	<b>BCC06HT</b>
				BCC A314-000-20-003-PX04A5-100	BCC A324-0000-20-003-PX04A5-100

Other cable materials, colors, and lengths on request.

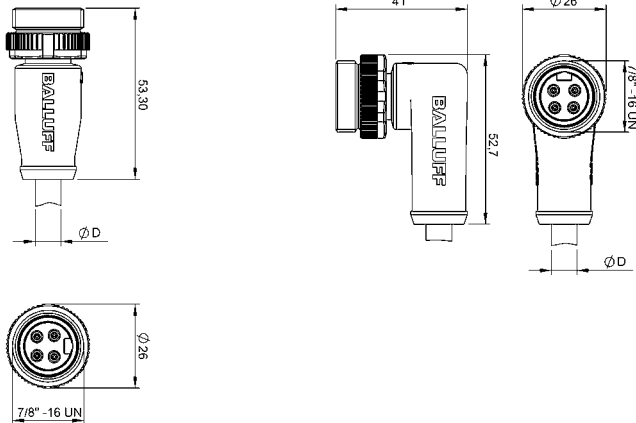

# Ethernet/IP

## Power cables 7/8", 4-pin



Profibus  
Profinet  
CC-Link  
Devicenet  
Ethernet/IP

Product topology  
IO-Link modules  
Modules  
Power tee

**Power cables**  
Power connectors  
Bus connection cable  
Bus couplings  
Bus connectors  
Accessories  
Bitmaps  
Technical data  
Display  
Unmanaged switch

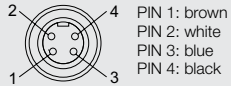

PIN 1: brown  
PIN 2: white  
PIN 3: blue  
PIN 4: black

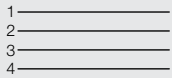

Female  
300 V DC  
4x1.5 mm<sup>2</sup>  
IP 68  
-25...+80° C

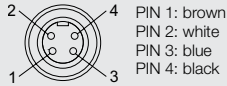

PIN 1: brown  
PIN 2: white  
PIN 3: blue  
PIN 4: black

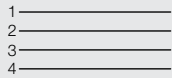

Female  
300 V DC  
4x1.5 mm<sup>2</sup>  
IP 68  
-25...+80° C

### Ordering code

Part number

#### BCC06HU

BCC A314-0000-10-003-PX04A5-020

#### BCC06HZ

BCC A324-0000-10-003-PX04A5-020

#### BCC06HW

BCC A314-0000-10-003-PX04A5-050

#### BCC06J0

BCC A324-0000-10-003-PX04A5-050

#### BCC06HY

BCC A314-0000-10-003-PX04A5-100

#### BCC06J1

BCC A324-0000-10-003-PX04A5-100

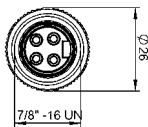
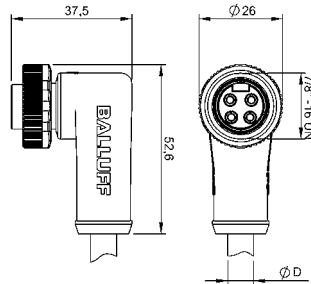
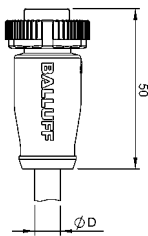

## Power connection cables 7/8", 4-pin



Connector diagram and wiring	<p>PIN 1: brown PIN 2: white PIN 3: blue PIN 4: black</p>	<p>PIN 1: brown PIN 2: white PIN 3: blue PIN 4: black</p>
Type	Female/male	Female/male
Supply voltage $U_b$	300 V DC	300 V DC
Number of conductors × conductor cross-section	4×1.5 mm <sup>2</sup>	4×1.5 mm <sup>2</sup>
Degree of protection as per IEC 60529	IP 68	IP 68
Ambient temperature $T_a$	-25...+80° C	-25...+80° C

Cable material	Color	Length	Ordering code
PUR	Black	0.6 m	<b>BCC06J2</b> BCC A314-A314-30-304-PX04A5-006
PUR	Black	2 m	<b>BCC06J3</b> BCC A314-A314-30-304-PX04A5-020
PUR	Black	5 m	<b>BCC06J4</b> BCC A314-A314-30-304-PX04A5-050
PUR	Black	10 m	<b>BCC06J5</b> BCC A314-A314-30-304-PX04A5-100
PUR	Black	15 m	<b>BCC06J6</b> BCC A314-A314-30-304-PX04A5-150
			<b>BCC06J7</b> BCC A314-A324-30-304-PX04A5-006
			<b>BCC06J8</b> BCC A314-A324-30-304-PX04A5-020
			<b>BCC06J9</b> BCC A314-A324-30-304-PX04A5-050
			<b>BCC06JA</b> BCC A314-A324-30-304-PX04A5-100
			<b>BCC06JC</b> BCC A314-A324-30-304-PX04A5-150

Other cable materials, colors, and lengths on request.

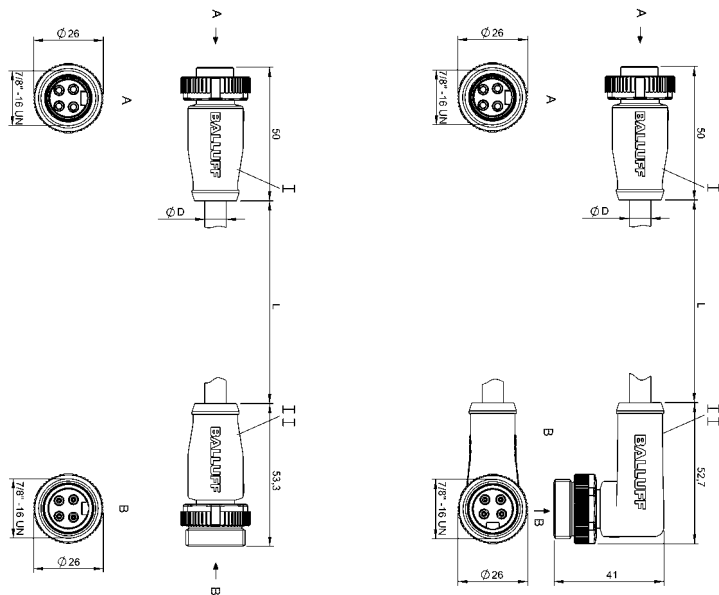

# Ethernet/IP

## Power connection cables 7/8", 4-pin



Profibus  
Profinet  
CC-Link  
Devicenet  
Ethernet/IP

Product topology  
IO-Link modules  
Modules  
Power tee  
**Power cables**  
Power connectors  
Bus connection cable  
Bus couplings  
Bus connectors  
Accessories  
Bitmaps  
Technical data  
Display  
Unmanaged switch

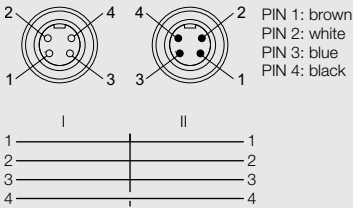

PIN 1: brown  
PIN 2: white  
PIN 3: blue  
PIN 4: black

Female/male  
300 V DC  
4×1.5 mm<sup>2</sup>  
IP 68  
-25...+80° C

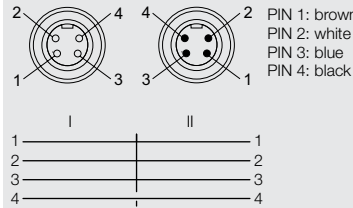

PIN 1: brown  
PIN 2: white  
PIN 3: blue  
PIN 4: black

Female/male  
300 V DC  
4×1.5 mm<sup>2</sup>  
IP 68  
-25...+80° C

### Ordering code

Part number

#### BCC06JE

BCC A324-A314-30-304-PX04A5-006

#### BCC06JF

BCC A324-A314-30-304-PX04A5-020

#### BCC06JH

BCC A324-A314-30-304-PX04A5-050

#### BCC06JJ

BCC A324-A314-30-304-PX04A5-100

#### BCC06JK

BCC A324-A314-30-304-PX04A5-150

#### BCC06JL

BCC A324-A324-30-304-PX04A5-006

#### BCC06JM

BCC A324-A324-30-304-PX04A5-020

#### BCC06JN

BCC A324-A324-30-304-PX04A5-050

#### BCC06JP

BCC A324-A324-30-304-PX04A5-100

#### BCC06JR

BCC A324-A324-30-304-PX04A5-150

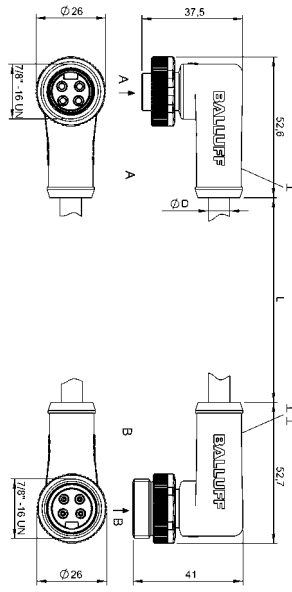
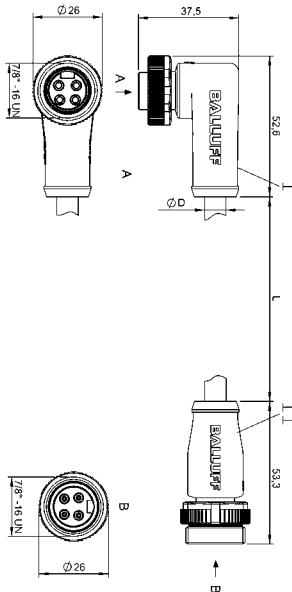



Power plug connector, 7/8", 4-pin



Connector diagram and wiring		
Type	Female	Male
Supply voltage U <sub>B</sub>	250 V	250 V
Number of conductors × conductor cross-section	4 × max. 1.5 mm <sup>2</sup>	4 × 1.5 mm <sup>2</sup>
Degree of protection as per IEC 60529	IP 67	IP 67
Ambient temperature T <sub>a</sub>	-25...+80 °C	-25...+80 °C

Cable material	Color	Ordering code	
Cable dia.		Part number	
PUR	Black	<b>BCC0706</b>	<b>BCC0709</b>
6...8 mm		BCC A334-0000-10-000-51X4A5-000	BCC A334-0000-20-000-51X4A5-000
PUR	Black	<b>BCC0707</b>	<b>BCC070A</b>
8...10 mm		BCC A334-0000-10-000-61X4A5-000	BCC A334-0000-20-000-61X4A5-000
PUR	Black	<b>BCC0708</b>	<b>BCC070C</b>
10...12 mm		BCC A334-0000-10-000-71X4A5-000	BCC A334-0000-20-000-71X4A5-000

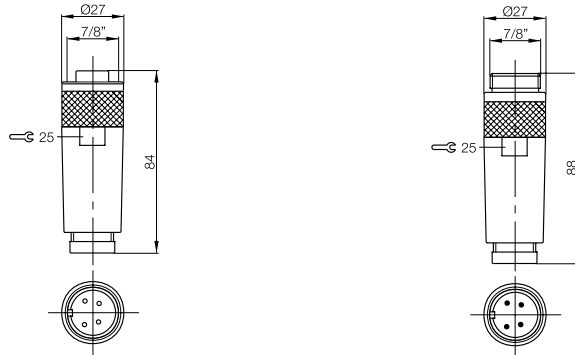



- Profibus
- Profinet
- CC-Link
- Devicenet
- Ethernet/IP
- Product topology
- IO-Link modules
- Modules
- Power tee
- Power cables
- Power connectors**
- Bus connection cable
- Bus couplings
- Bus connectors
- Accessories
- Bitmaps
- Technical data
- Display
- Unmanaged switch





Connector diagram and wiring			
Description	T splitter	Screw plug 7/8"	Screw plug 7/8"
Use	2x M12 female to 1x M12 male	Cover for the power ports	Cover for the power ports
<b>Ordering code</b>	<b>BCC089P</b>	<b>BAM012T</b>	<b>BAM012U</b>
Part number	BCC M415-M415-M415-U0003-000	BKS-7/8-CS-00-A	BKS-7/8-CS-00-I
Supply voltage $U_b$	125 V		
Rated operating current $I_o$	4 A		
Degree of protection as per IEC 60529	IP 67		
Ambient temperature $T_a$	-25...+80 °C	-20...+80 °C	-20...+80 °C
Housing material	PA 6.6 + GF	Nickel-plated CuZn	Nickel-plated CuZn

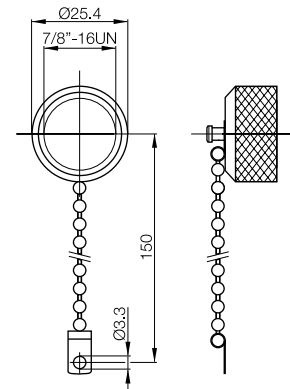
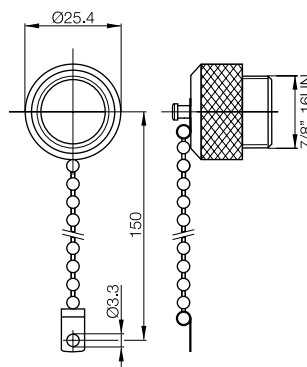
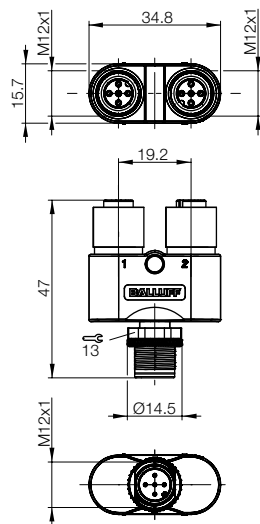

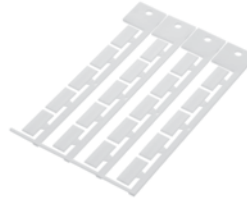

Profibus  
Profinet  
CC-Link  
Devicenet  
Ethernet/IP

Product topology  
IO-Link modules  
Modules  
Power tee  
Power cables  
Power connectors  
Bus connection cable  
Bus couplings  
Bus connectors  
**Accessories**  
Bitmaps  
Technical data  
Display  
Unmanaged switch

Description	M12 locking screw	Marking sleeve	Label set	
Use	IP 65 threaded cover for unused ports	For labeling connectors	Labeling the ports for modules BNI PBS..., BNI PNT..., BNI DNT..., BNI EIP..., BNI CCL...	
<b>Ordering code</b>	<b>BAM01C2</b>		<b>BAM01AT</b>	
Part number	BAM CS-XA-002-M12-A	BAM IA-CC-002-01	BNI ACC-L01-000	
Ambient temperature T <sub>a</sub>	-20...+80 °C			
Housing material	Plastic		Plastic	

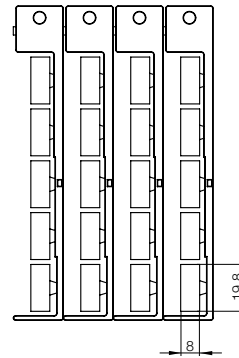
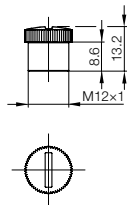

## 16 inputs

		Bit 7	Bit 6	Bit 5	Bit 4	Bit 3	Bit 2	Bit 1	Bit 0	Bit 7	Bit 6	Bit 5	Bit 4	Bit 3	Bit 2	Bit 1	Bit 0
IN	Byte 1/Byte 0	I-15	I-14	I-13	I-12	I-11	I-10	I-9	I-8	I-7	I-6	I-5	I-4	I-3	I-2	I-1	I-0
	Byte 3/Byte 2	S-15	S-14	S-13	S-12	S-11	S-10	S-9	S-8	S-7	S-6	S-5	S-4	S-3	S-2	S-1	S-0
	Byte 4															SP	
OUT	Byte 1/Byte 0	Display (Series 100 only)								IPAP							

## 8 outputs

		Bit 7	Bit 6	Bit 5	Bit 4	Bit 3	Bit 2	Bit 1	Bit 0	Bit 7	Bit 6	Bit 5	Bit 4	Bit 3	Bit 2	Bit 1	Bit 0
IN	Byte 1/Byte 0	OL-7	OL-6	OL-5	OL-4	OL-3	OL-2	OL-1	OL-0	HS-7	HS-6	HS-5	HS-4	HS-3	HS-2	HS-1	HS-0
	Byte 2																AP
OUT	Byte 1/Byte 0	R-7	R-6	R-5	R-4	R-3	R-2	R-1	R-0	O-7	O-6	O-5	O-4	O-3	O-2	O-1	O-0
	Byte 3/Byte 2	Display								IPAP							

## 16 outputs

		Bit 7	Bit 6	Bit 5	Bit 4	Bit 3	Bit 2	Bit 1	Bit 0	Bit 7	Bit 6	Bit 5	Bit 4	Bit 3	Bit 2	Bit 1	Bit 0
IN	Byte 1/Byte 0	HS-15	HS-14	HS-13	HS-12	HS-11	HS-10	HS-9	HS-8	HS-7	HS-6	HS-5	HS-4	HS-3	HS-2	HS-1	HS-0
	Byte 3/Byte 2	OL-15	OL-14	OL-13	OL-12	OL-11	OL-10	OL-9	OL-8	OL-7	OL-6	OL-5	OL-4	OL-3	OL-2	OL-1	OL-0
	Byte 4																AP
OUT	Byte 1/Byte 0	O-15	O-14	O-13	O-12	O-11	O-10	O-9	O-8	O-7	O-6	O-5	O-4	O-3	O-2	O-1	O-0
	Byte 3/Byte 2	R-15	R-14	R-13	R-12	R-11	R-10	R-9	R-8	R-7	R-6	R-5	R-4	R-3	R-2	R-1	R-0
	Byte 5/Byte 4	Display								IPAP							

## 8 inputs/8 outputs

		Bit 7	Bit 6	Bit 5	Bit 4	Bit 3	Bit 2	Bit 1	Bit 0	Bit 7	Bit 6	Bit 5	Bit 4	Bit 3	Bit 2	Bit 1	Bit 0
IN	Byte 1/Byte 0	S-7	S-6	S-5	S-4	S-3	S-2	S-1	S-0	I-7	I-6	I-5	I-4	I-3	I-2	I-1	I-0
	Byte 3/Byte 2	OL-7	OL-6	OL-5	OL-4	OL-3	OL-2	OL-1	OL-0	HS-7	HS-6	HS-5	HS-4	HS-3	HS-2	HS-1	HS-0
	Byte 4															SP	AP
OUT	Byte 1/Byte 0	R-7	R-6	R-5	R-4	R-3	R-2	R-1	R-0	O-7	O-6	O-5	O-4	O-3	O-2	O-1	O-0
	Byte 3/Byte 2	Display								IPAP							

## 32 inputs

		Bit 7	Bit 6	Bit 5	Bit 4	Bit 3	Bit 2	Bit 1	Bit 0	Bit 7	Bit 6	Bit 5	Bit 4	Bit 3	Bit 2	Bit 1	Bit 0
IN	Byte 1/Byte 0	I-15	I-14	I-13	I-12	I-11	I-10	I-9	I-8	I-7	I-6	I-5	I-4	I-3	I-2	I-1	I-0
	Byte 3/Byte 2	I-31	I-30	I-29	I-28	I-27	I-26	I-25	I-24	I-23	I-22	I-21	I-20	I-19	I-18	I-17	I-16
	Byte 5/Byte 4	S-15	S-14	S-13	S-12	S-11	S-10	S-9	S-8	S-7	S-6	S-5	S-4	S-3	S-2	S-1	S-0
	Byte 7/Byte 6	S-31	S-30	S-29	S-28	S-27	S-26	S-25	S-24	S-23	S-22	S-21	S-20	S-19	S-18	S-17	S-16
	Byte 8															SP	
OUT	Byte 1/Byte 0	Display								IPAP							

## 8 inputs/8 outputs

		Bit 7	Bit 6	Bit 5	Bit 4	Bit 3	Bit 2	Bit 1	Bit 0	Bit 7	Bit 6	Bit 5	Bit 4	Bit 3	Bit 2	Bit 1	Bit 0
IN	Byte 1/Byte 0	I-15	I-14	I-13	I-12	I-11	I-10	I-9	I-8	I-7	I-6	I-5	I-4	I-3	I-2	I-1	I-0
	Byte 3/Byte 2	S-15	S-14	S-13	S-12	S-11	S-10	S-9	S-8	S-7	S-6	S-5	S-4	S-3	S-2	S-1	S-0
	Byte 5/Byte 4	HS-15	HS-14	HS-13	HS-12	HS-11	HS-10	HS-9	HS-8	HS-7	HS-6	HS-5	HS-4	HS-3	HS-2	HS-1	HS-0
	Byte 7/Byte 6	OL-15	OL-14	OL-13	OL-12	OL-11	OL-10	OL-9	OL-8	OL-7	OL-6	OL-5	OL-4	OL-3	OL-2	OL-1	OL-0
	Byte 8															SP	AP
OUT	Byte 1/Byte 0	O-15	O-14	O-13	O-12	O-11	O-10	O-9	O-8	O-7	O-6	O-5	O-4	O-3	O-2	O-1	O-0
	Byte 3/Byte 2	R-15	R-14	R-13	R-12	R-11	R-10	R-9	R-8	R-7	R-6	R-5	R-4	R-3	R-2	R-1	R-0
	Byte 5/Byte 4	Display								IPAP							

Bitmap legend	
I	Input
O	Output
R	Output reset
S	Input short-circuit
OL	Output overload status
HS	Output handshake
AP	Actuator power status
SP	Sensor/network power status

Output control byte display (Series 100 only)	
Bit 0	Red LED illuminates
Bit 1	Green LED illuminates
Bit 2	Display disable
Bit 3	
Bit 4	
Bit 5	
Bit 6	
Bit 7	

## Pin assignments

### Ethernet

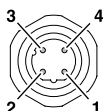

Pin No.	Function
1	TD+
2	RD+
3	TD-
4	RD-

### I/O port

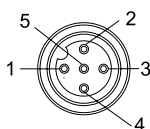

Input port	
Pin No.	Function
1	V+
2	Input
3	0 V
4	Input
5	Ground GND

Output port	
Pin No.	Function
1	
2	Output
3	0 V
4	Output
5	Ground GND

### Auxiliary power

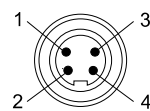

Pin No.	Function
1	Actuator (+24 V)
2	Sensor (+24 V)
3	GND sensor
4	GND actuator

## Information on grounding

With a standard European grounding connection, use a joint ground point for all blocks (see first illustration). All blocks remain within the same grounding potential. Grounding straps are included for mounting on a painted surface.

If a single-point grounding system is not implemented, it is possible to use a varying grounding potential. However, the shield then generates an equalizing current that has a negative effect on data transmission since it can cause interruptions to communication.

With most grounding connections in North America, local machines with completely shielded cables are each connected to a separate ground. This is described in ODVA publication PUB00148RO, "Ethernet/IP Media Planning and Installation Manual."

ODVA recommends that the shield be connected to ground at the switch and not at the network device. Ethernet specification IEEE802.3 also permits the use of unshielded cables.

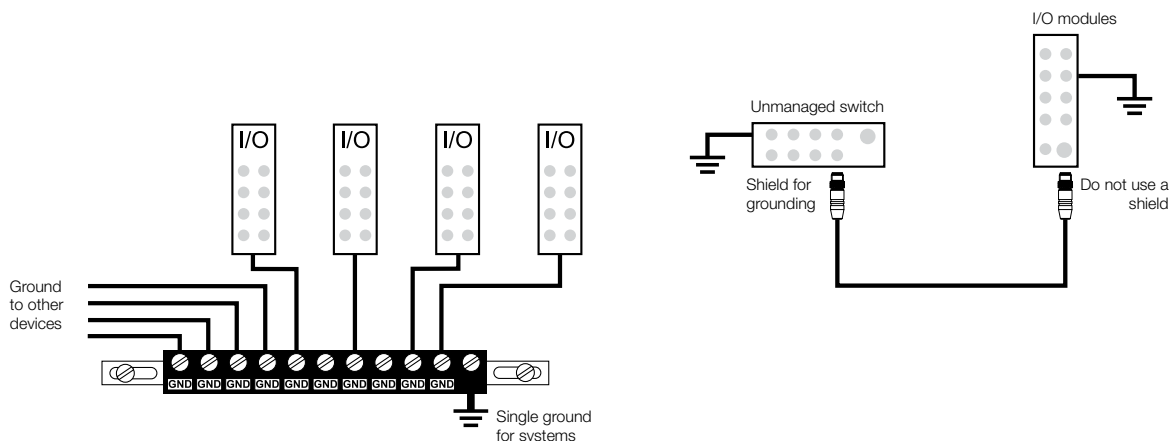

## Ethernet/IP modules Display with operating buttons

The Balluff Series 100 modules feature a digital display with two operating buttons that can be used to program the IP address, subnet and gateway address. You can also view the hardware and software versions from the module. When unused, octet 0 of the IP address is displayed by default.

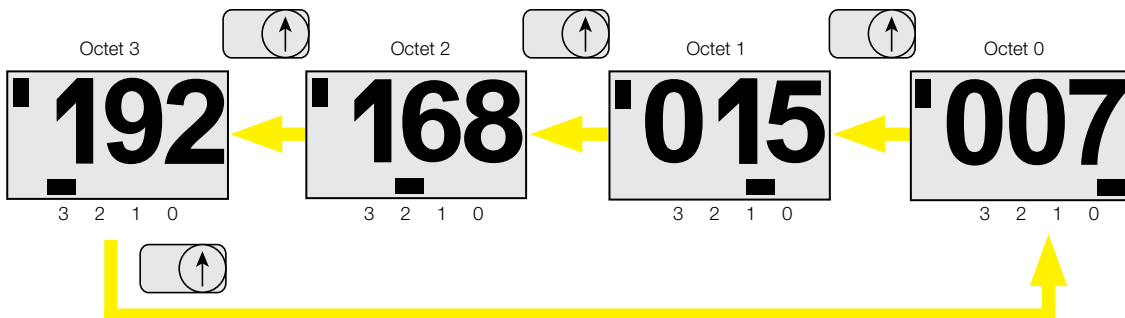
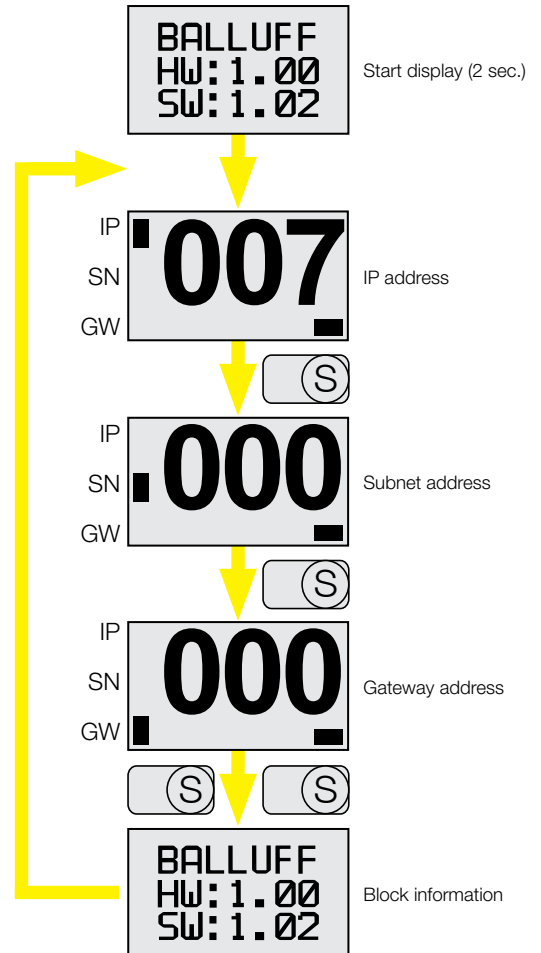
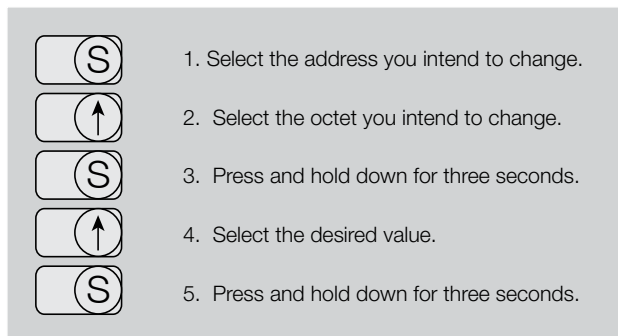
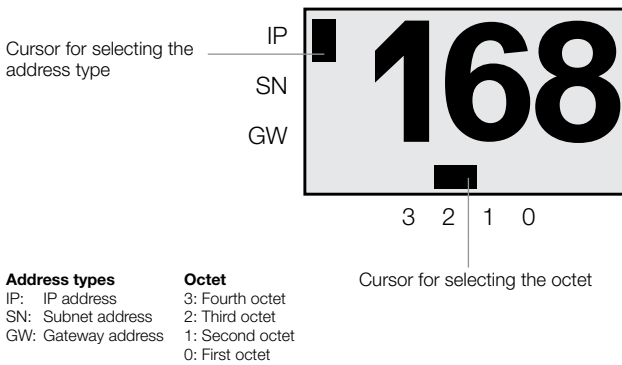



### User-defined functions

#### User-defined LEDs

The green and red LEDs indicate errors and provide the user with assistance when troubleshooting during maintenance.



#### Disable buttons

Using the controller as an interface, the operating buttons can be disabled in order to prevent unauthorized access.

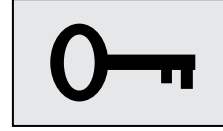

- Profibus
- Profinet
- CC-Link
- Devicenet
- Ethernet/IP
- Product topology
- IO-Link modules
- Modules
- Power tee
- Power cables
- Power connectors
- Bus connection cable**
- Bus couplings
- Bus connectors
- Accessories
- Bitmaps
- Technical data
- Display**
- Unmanaged switch

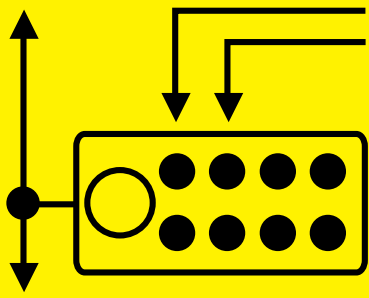

# Fieldbus Systems

Fieldbus System: Unmanaged Switches



# Unmanaged Switches

## Contents

Port switches  
Ethernet switches

130  
131

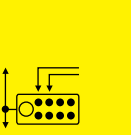

# Unmanaged Switches

## Port switches

### Ethernet 5-port switch IP 20

### Ethernet 8-port switch IP 20

### Ethernet 9-port switch IP 67

Ethernet-based network systems are gaining more and more importance in industrial automation. Balluff provides a wide variety of Ethernet-based systems and network components such as Profinet or Ethernet/IP for machine and plant equipment.

With Balluff, you receive a complete system so that you can use Ethernet to link Ethernet system components easily. The Ethernet product line was expanded with the addition of 5-port and 8-port Ethernet switches for this reason.

The switch makes it possible to connect 5-port and 8-port Ethernet devices to a component radially. The RJ45 ports and the 10 and 100 Mbps transmission rates support this. The transfer speed is automatically set via the auto-negotiation function. Wiring errors are reliably ruled out by the autocrossing function. This is because the module does not identify on its own what type of cable is being used.



Communication	Unmanaged switch
Version	No display
<b>Ordering code</b>	<b>BNI000F</b>
Part number	BNI EIP-950-000-Z009
Supply voltage $U_B$	24 V DC
Module current consumption	80...100 mA
Module status indicator: Mod LED	Yes
Network status indicator: Net LED	Yes
Network data transfer rate: link LED	Yes
Port status indicator	Black, red, yellow, green
Connection: Fieldbus	M12, D-coded, female
Connection: AUX power	7/8", male, 4-pin
Number of Ethernet ports	9
Degree of protection as per IEC 60529	IP 67
Operating temperature	0...+55 °C
Storage temperature	-25...+70 °C
Housing material	Nickel-plated GdZn
Transfer rates	10/100 Mbps, automatic detection, full-duplex
Degree of protection	IP 67
Max. switching frequency	32 gigabyte
Overload protection	IEEE 802.3
IP address space	IPv4
Approvals	ODVA, UL-CUL, CSA, CE

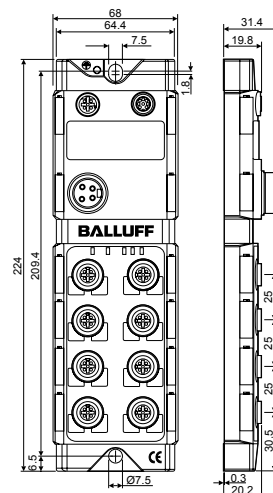

# Unmanaged Switches

## Ethernet switches



Profibus  
 Profinet  
 CC-Link  
 Devicenet  
 Ethernet/IP  
 Unmanaged switches  
**Port switches**  
**Ethernet switches**

Communication	Ethernet	Ethernet
Version	Ethernet switch	Ethernet switch
<b>Ordering code</b>	<b>BNI005E</b>	<b>BNI0067</b>
Part number	BNI TCP-951-000-E028	BNI TCP-952-000-E029
Ports	5×RJ45	8×RJ45
	Spring force clamp	Spring force clamp
System power supply	0.2...2.5 mm <sup>2</sup>	0.2...2.5 mm <sup>2</sup>
Supply voltage U <sub>B</sub>	12...48 V DC	2×12...30 V DC, redundant
Transfer rate	10/100 Mbps full duplex	10/100 Mbps full duplex
	Auto crossing	Auto crossing
Operating modes	Auto negotiation	Auto negotiation
Communication status	Link/run LED, (yellow/green)	Link/run LED, (yellow/green)
Supply voltage	LED (green), power	LED (green), power
Degree of protection	IP 20	IP 20
Housing	Black plastic	Black plastic
Temperature range	-10...+60 °C	-10...+60 °C
	(storage temperature -25...+70 °C)	(storage temperature -25...+70 °C)
Fastener	Snaps onto support rail TH35 (EN60715)	Snaps onto support rail TH35 (EN60715)
Weight	152 g	363 g

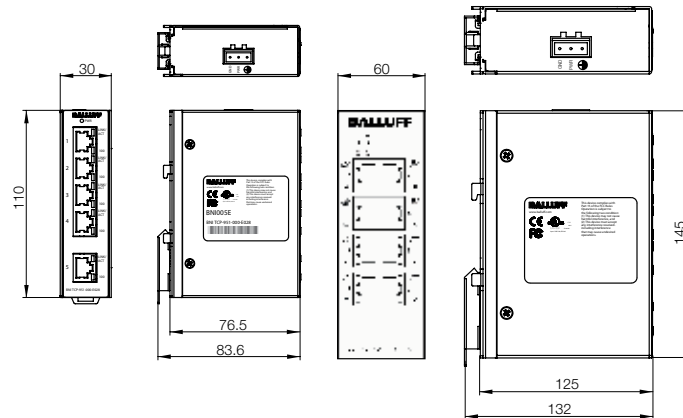

# IO-Link

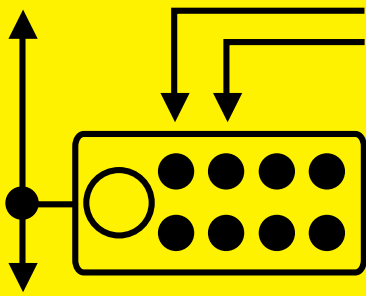

# IO-Link

## IO-Link interface

IO-Link is the first standardized, uniform, universally applicable interface in control technology to transmit all sensor and actuator signals to the controller. Likewise, IO-Link passes control data down to the lowest sensor level. All of this makes automation even more powerful than ever before. And it does it by simple means.

### IO-Link advantages at a glance

- Easy to get started, time-saving installation
- Automatic adjustment during ongoing operation
- Continuous monitoring



## **IO-Link**

Product topology			138
IO-Link sensor hub	M8 plastic	3-pin	140, 142
	M8 plastic	4-pin	141, 143
	M12 metal		145
	M12 plastic		150
IO-Link sensor/actuator hub			146, 154
IO-Link actuator hub	M12 metal		148
IO-Link sensors			156
IO-Link master			188
Accessories			190

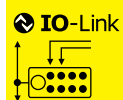

Profibus IO-Link modules starting on **page 22**  
 Profinet IO-Link modules starting on **page 46**  
 Connection cables BCC starting on **page 274**



# IO-Link

## Network technology for reliable data transfer and more efficiency

### More efficiency, lower costs

#### IO-Link saves time and money in overall production

IO-Link is all you need to make automation even more high-performance. This is because IO-Link provides substantial optimization and cost reduction potential for overall production.

The uniform, simple wiring, continuous diagnostics, and central configuration via the controller consequently provide an all-encompassing effect. And they do this in entirely different ways.

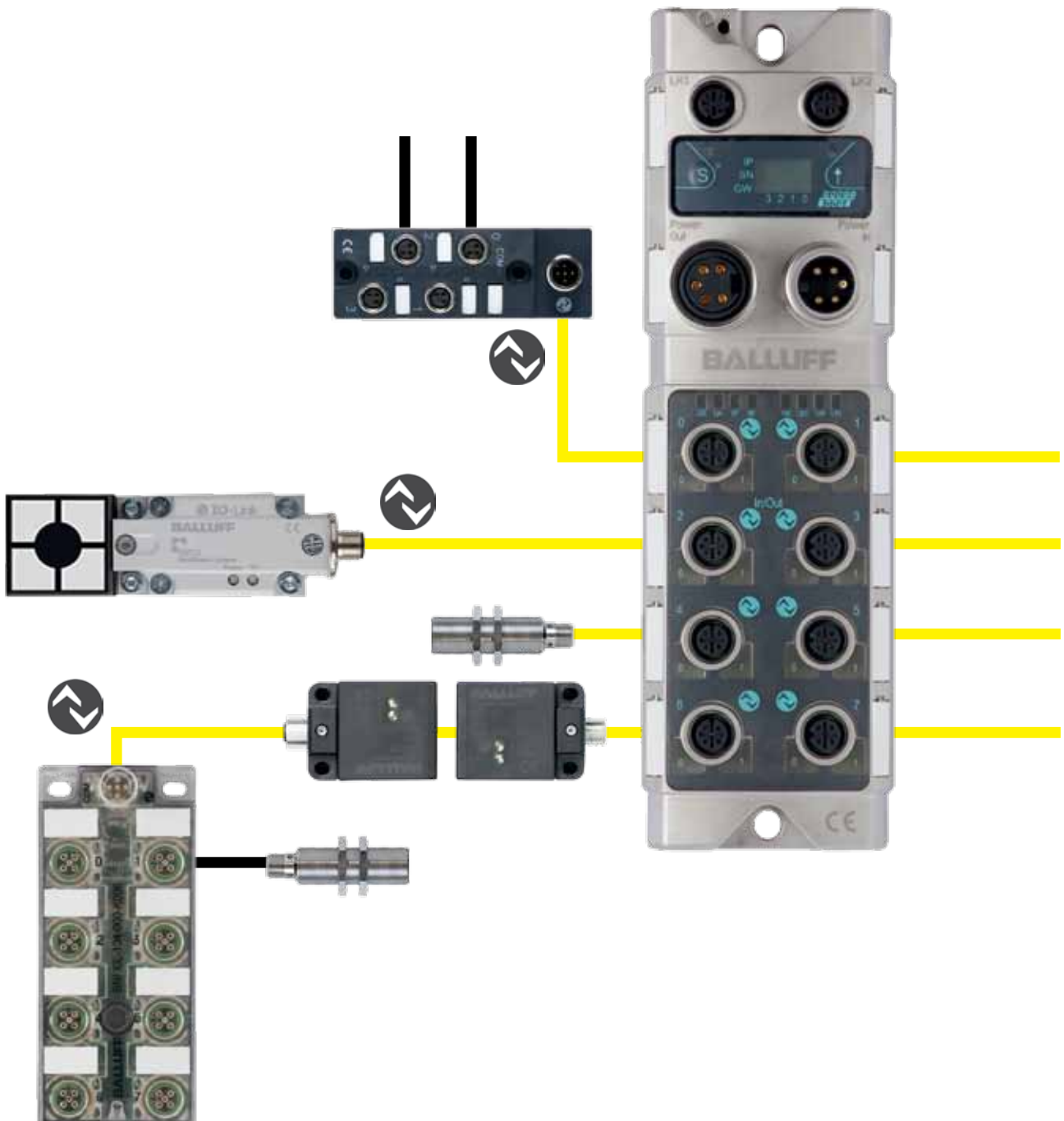



# IO-Link

## Network technology for reliable data transfer and more efficiency

### Simplification of installation

- Faster, simpler connection to an unshielded, three-core standard cable
- Standard sensors can also be integrated into the fieldbus level
- 8-fold IO-Link master for eight different IO-Link devices or eight hubs, each with up to 16 binary sensors
- Cost-saving due to fewer mechanical installations
- High security against interference thanks to digital communication



### Requirements-based maintenance

- Continuous diagnostics
- Automatic readjustment via the controller
- Predictive error detection
- Longer maintenance intervals

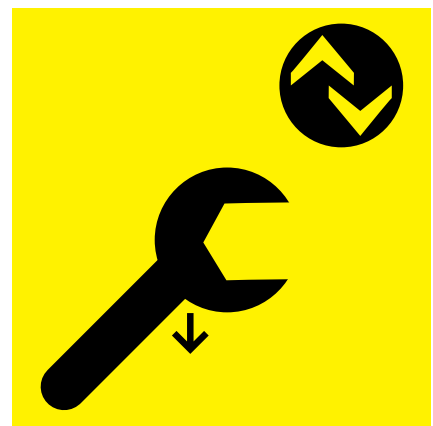

### More efficient operation

- Positioning of the sensors right where the action is
- Process monitoring, configuration and error analysis of the IO-Link devices via the controller
- Fast, high-performance data transmission
- Time-optimized machine processes
- High security against interference by means of digital communication
- A selection of sensors that is highly suited to the particular application because of the simultaneous use of binary, analog, and IO-Link sensors

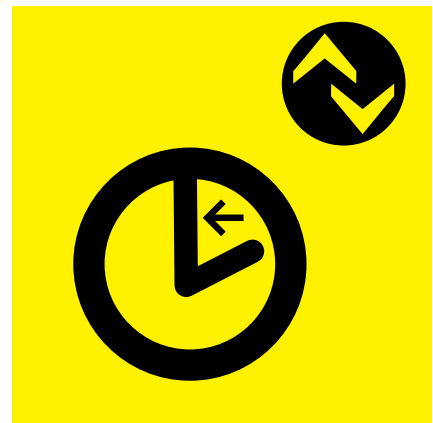

### Highest machine availability

- Faster, error-free sensor replacement and prompt commissioning
- Automatic configuration of an IO-Link sensor
- Prompt format changes and recipe changes centrally via the controller
- Additional security from clearly identifiable IO-Link devices

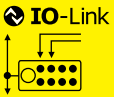
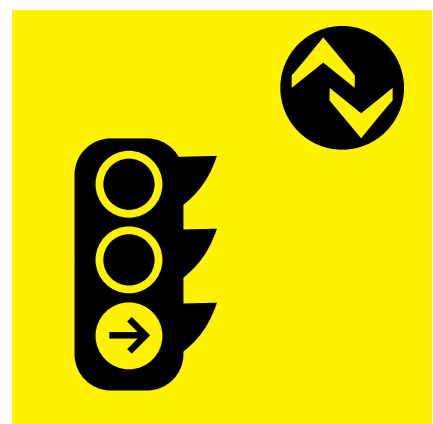

## Network technology for flexible installation and reliable data transfer

### Flexible installation of Profibus and Profinet with IO-Link

- Quick
- Low cost thanks to the use of economical components and standard cables
- Shorter downtimes during installation, maintenance and operation

Depending on model type, the ports of the Balluff IO-Link distributor modules can be configured as a (diagnostic) input, output or IO-Link port. For each port, pin 2 or pin 4 can be used as input and output or for diagnostics.

IO-Link ports are labeled with the IO-Link symbol.

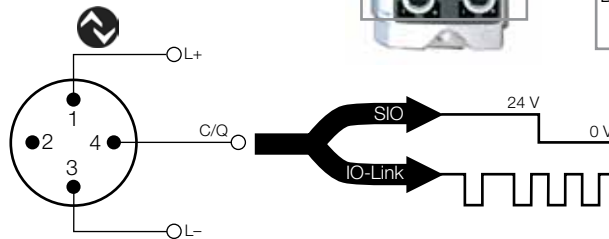
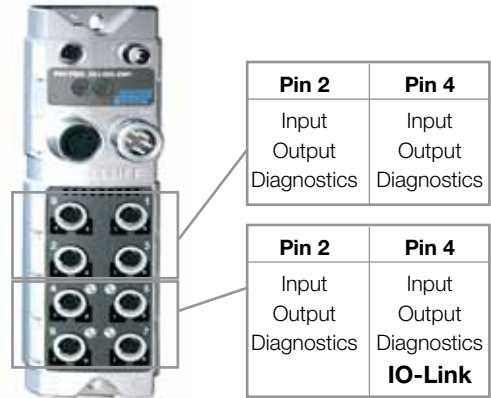

### End-of-arm tooling

See the actual advantages of IO-Link in use

Modern robot systems require numerous sensors – particularly robot arms, which only tolerate lightweight sensors. High-performance Balluff sensor hubs prove their worth not only with their low weight, but also their ability to bundle and transmit sensor signals easily via IO-Link and a standard 3-core cable.

Balluff also offers economical, drag chain-compatible M12 standard cables BCC that are ideal for robots.

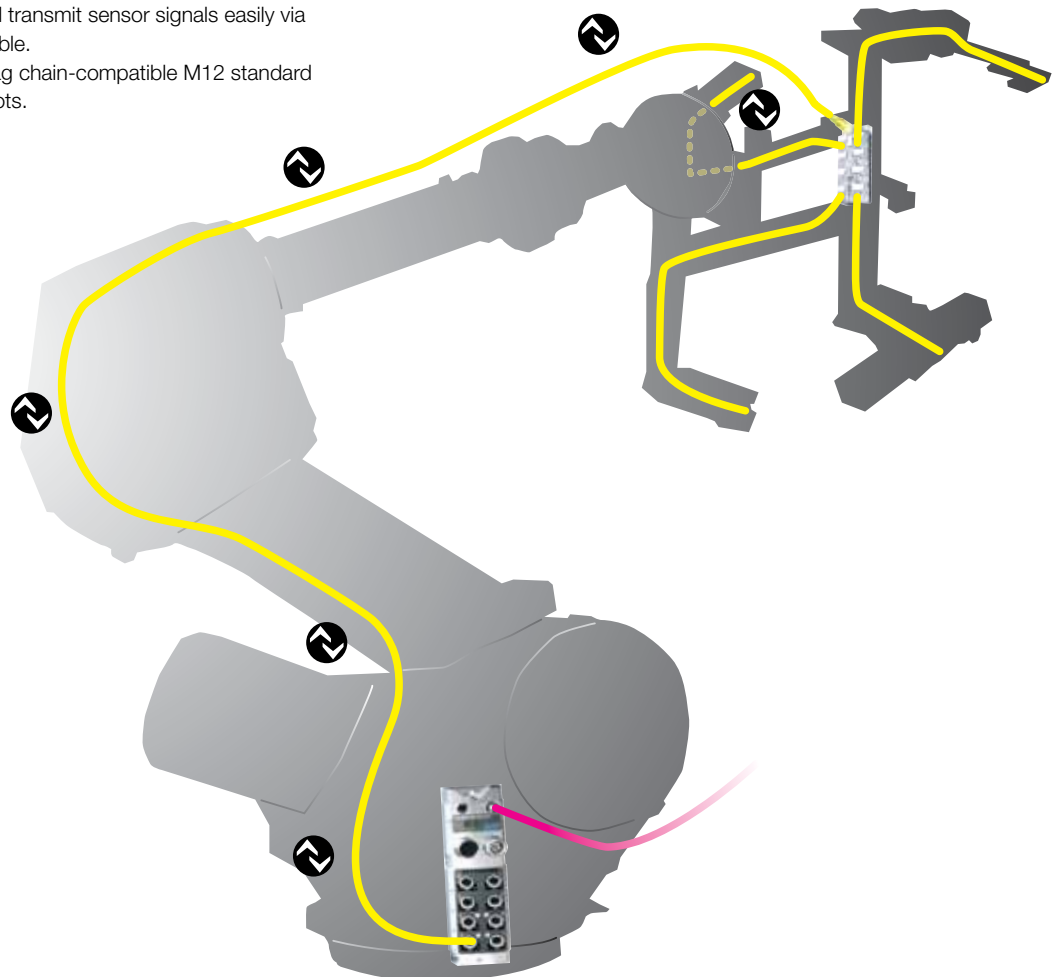

# IO-Link

## Network technology for reduced costs and greater efficiency

### Balluff IO-Link sensor hubs save money

You save a great deal of money during the installation of IO-Link sensor hubs: 15 to 20% per input compared to Profibus and Profinet.

If you add the savings from Profibus and power cables, the cost savings are as much as 30 to 40%. One inexpensive M12 standard cable BCC suffices. Furthermore, sensor hubs need just one bus address to variably group sensor signals together within an area of 20 m and to ensure exceptional efficiency.

### Cost-effective installation with high functionality

The high costs of field installations can be attributed to shielded cables and analog input cards. IO-Link sensor hubs not only solve the problem of fault-prone analog inputs, but also reduce wiring, testing and hardware costs. Thanks to simple plug-and-play of unshielded, economical M12 cables, you can

### Standard Profibus/Profinet

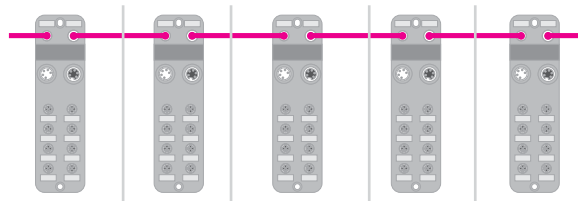

50...60% reduction    50...60% reduction    40...60% increase    50...60% reduction    50...60% reduction

Total cost savings 30...40%

### IO-Link solution

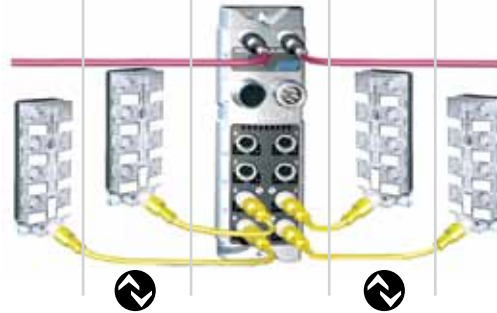

conveniently set up the system in just one minute without so much as screwdriver. For a standard connection, you would need around 30 minutes. Clear IO-Link advantages that speak for themselves.

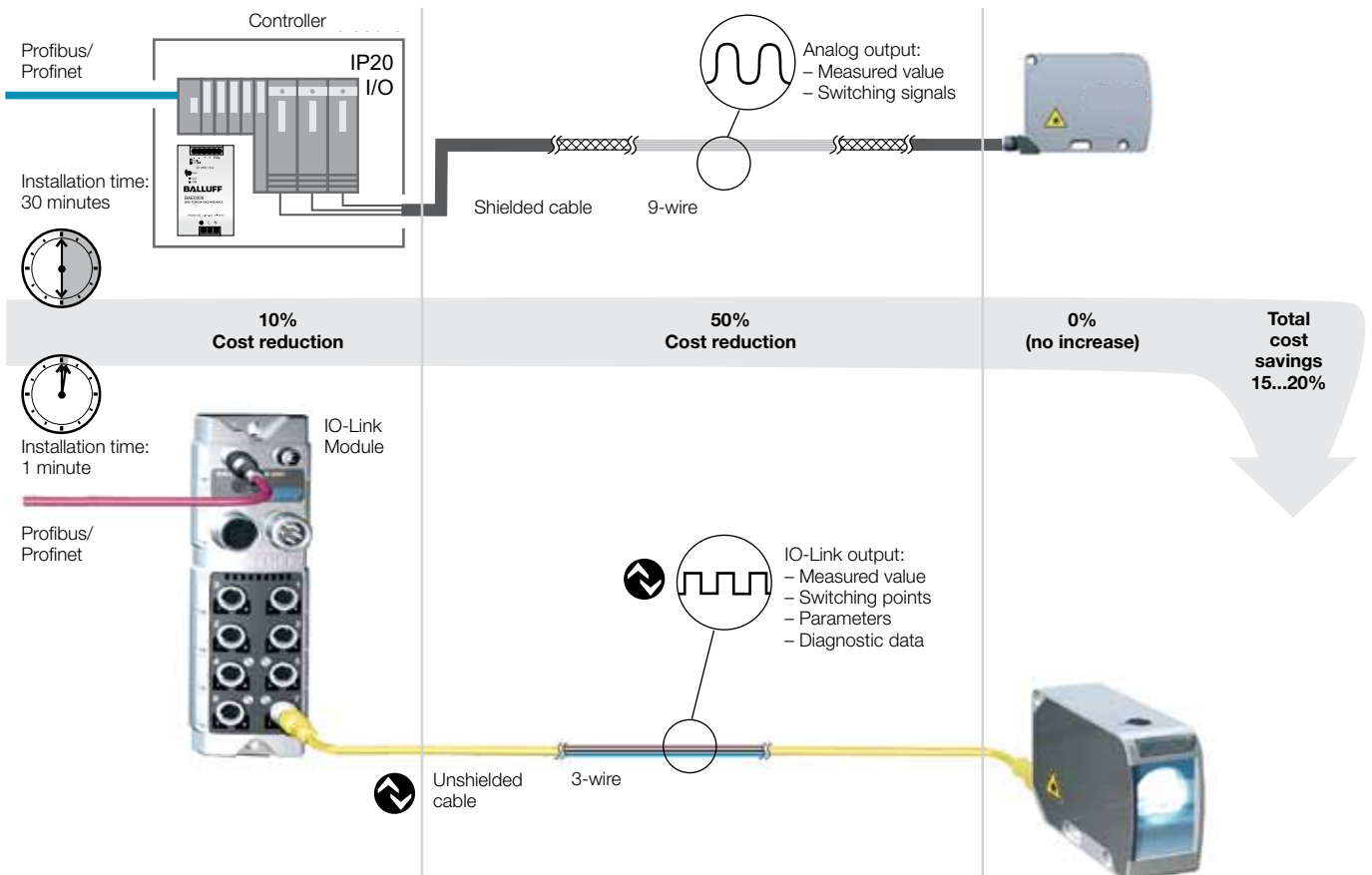

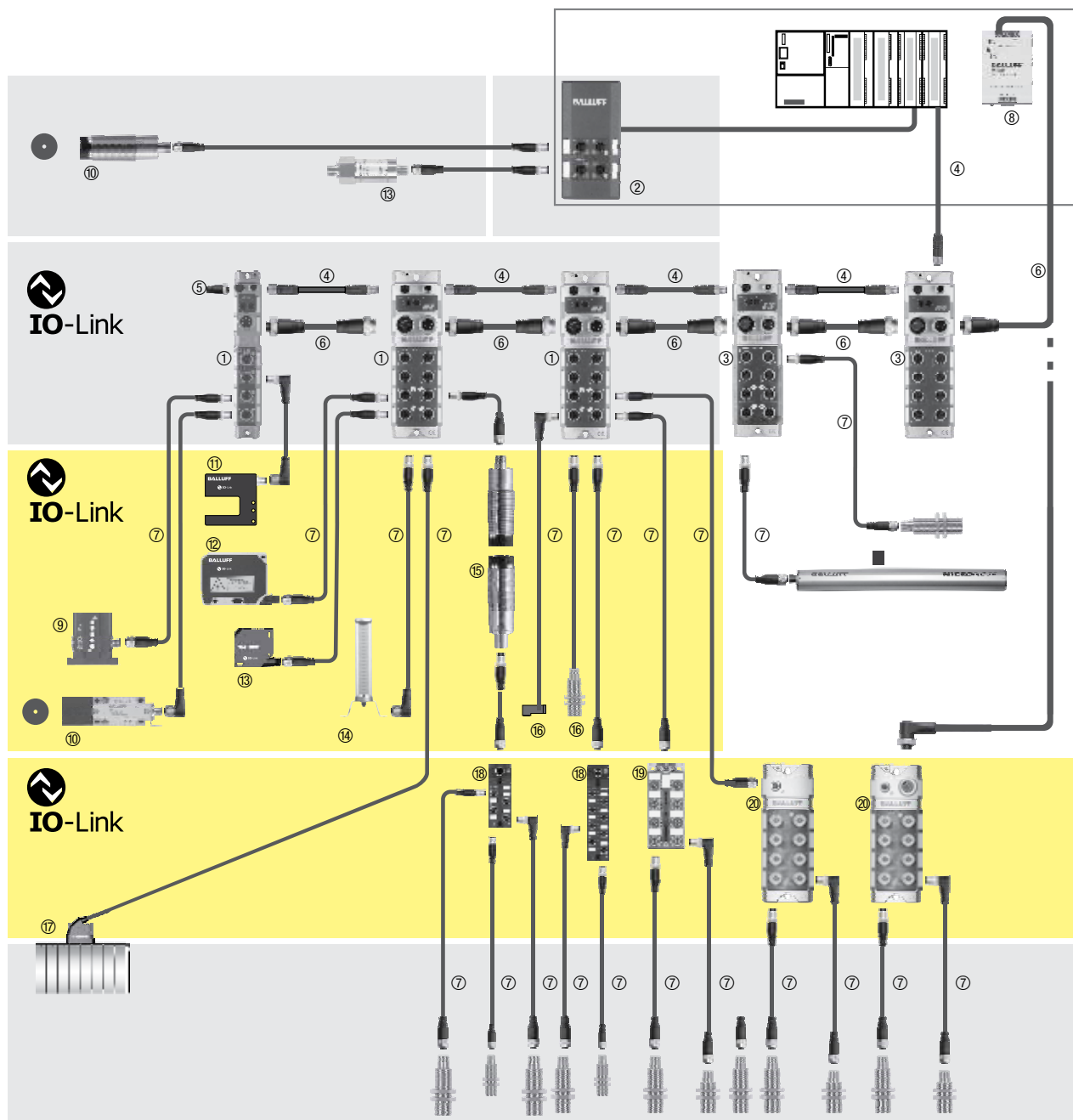

## IO-Link

- |  |             |  |          |
|--|-------------|--|----------|
| ① Profibus/Profinet IO-Link module BNI | Page 22, 46 | ⑨ IO-Link multiple position switches BNS | Page 171 |
| ② Profibus IO-Link panel module BNI    | Page 27     | ⑩ IO-Link RFID system BIS                | Page 164 |
| ③ Profibus/Profinet module BNI         | Page 23, 47 | ⑪ IO-Link fork sensor BGL                | Page 157 |
| ④ Bus cable BCC                        | Page 30     | ⑫ IO-Link laser distance sensor BOD      | Page 159 |
| ⑤ Terminating resistor                 | Page 36     | ⑬ IO-Link color sensor BFS               | Page 158 |
| ⑥ Power cable BCC                      | Page 28     | ⑭ IO-Link SmartLight                     | Page 187 |
| ⑦ Connection cable BCC                 | Page 336    | ⑮ IO-Link inductive couplers BIC         | Page 210 |
| ⑧ Power supplies BAE                   | Page 365    | ⑯ IO-Link inductive distance sensors BAW | Page 160 |
|  |             | ⑰ IO-Link valve terminal connector BNI   | Page 180 |
|  |             | ⑱ IO-Link sensor hub BNI M8              | Page 140 |
|  |             | ⑲ IO-Link sensor hub BNI M12             | Page 145 |
|  |             | ⑳ Metal IO-Link sensor hub               | Page 146 |

With IO-Link modules, you can quickly and reliably simplify your network and save costs through reduced hardware, easy handling, high flexibility and greater efficiency.

### Fieldbus modules

#### Reduce wiring costs

- Easily expand fieldbus modules with up to 8 sensor hubs. Everything according to your needs. You can connect up to 128 inputs/outputs per node and save costs

#### Simple integration

- Only the bus module needs an address

#### Flexible adaptation

- Whether input/output or IO-Link port – you configure the device yourself and design your system with complete flexibility

#### Compact and efficient

- Compact design with high function density: up to two sensors/actuators can be connected to each M12 connector

### The advantages for your network

- **Quick and easy network setup and modification**
- **Simple expansion of your network with the same number of fieldbus nodes**
- **Reliably reduce fieldbus nodes**

### Sensor hubs

#### Simple integration

- Sensor hubs can be configured easily via fieldbus

#### Low space requirements

- Smaller in size than a bus splitter

#### Flexible adaptation

- Each of the 16 inputs can be configured as NC or NO

#### Ready to use immediately

- One sensor hub provides 16 additional inputs/outputs

#### Low costs

- Simple Plug-and-Play of inexpensive, industrial-quality, unshielded 3-pin M12 cables

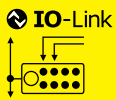

IO-Link

#### Product topology

M8 plastic IO-Link sensor hubs

M12 metal IO-Link sensor hubs

M12 plastic IO-Link sensor hubs

IO-Link sensor/actuator hubs

M12 metal IO-Link actuator hubs

IO-Link sensors

IO-Link master

Accessories

Profibus IO-Link modules starting on **page 22!**

Profinet IO-Link modules starting on **page 46!**



**Simple handling, fast data, four variants**

The space-saving M8 sensor hubs with IO-Link interface are the first choice wherever space is limited, because they offer up to 16 inputs in the tightest of spaces. And their low weight makes them recommended for weight-critical applications. M8 sensor hubs are easy to install and save time, because a 3-pin standard cable is sufficient for the connection. M8 sensor hubs are time and cost saving, even during maintenance and in system operation. This is because, like all IO-Link products, they ensure consistent diagnostics and can be configured centrally. M8 sensor hubs are also particularly fast. Transmission of 16 sensor signals, for example, takes just 2.5 ms. This ensures that the controller always receives current information. Each individual channel can be programmed to function as normally closed (NC) or normally open (NO), which allows the connection of complementary sensors (DESINA).

M8 sensor hubs with IO-Link port are available in four variants.



IO-Link Version	Device 4× DI	Device 8× DI
<b>Ordering code</b>	<b>BNI000P</b>	<b>BNI000R</b>
Part number	BNI IOL-101-000-K018	BNI IOL-102-000-K019
Supply voltage $U_B$	18...30 V DC	18...30 V DC
Power-on indicator	Green LED	Green LED
Connection: I/O ports	M8, 3-pin, female	M8, 3-pin, female
Connection: IO-Link port	M12, A-coded, male	M12, A-coded, male
No. of I/O ports	4	8
Number of inputs	4 PNP	8 PNP
Configurable	NC/NO	NC/NO
Input status indicator	Yellow LED	Yellow LED
Total current $U_T$	max. 800 mA	max. 800 mA
Degree of protection as per IEC 60529	IP 67 (when screwed into place)	IP 67 (when screwed into place)
Operating temperature $T_a$	-5...+55 °C	-5...+55 °C
Storage temperature	-25...+70 °C	-25...+70 °C
Weight	Approx. 86 g	Approx. 103 g
Fastener	2 mounting holes	2 mounting holes
Dimensions (L×W×H)	85×30×23.7 mm	129.5×30×23.7 mm
Housing material	Plastic	Plastic

**IO-Link**

No. of IO-Link ports	1× device	1× device
Operating mode	COM 2	COM 2
IO-Link process data length	1 input byte	1 input byte
Indicators	Communication Green LED, pulsing	Green LED, pulsing
Error	Red LED	Red LED
Parameter	NC/NO per input	NC/NO per input

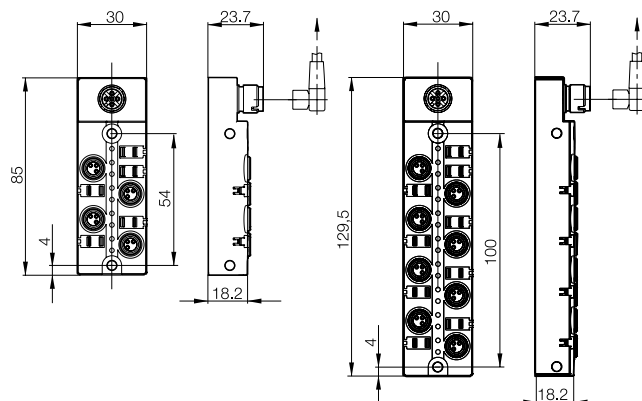

**All hubs include four screw plugs and a label set.**

# IO-Link

## M8 sensor hubs, IP 67, 4-pin

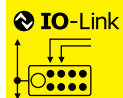

IO-Link	Device		
Version	16× DI		
<b>Ordering code</b>	<b>BNI0021</b>		
Part number	BNI IOL-104-000-K021		
Supply voltage $U_b$	18...30 V DC		
Power-on indicator	Green LED		
Connection: I/O ports	M8, 4-pin, female		
Connection: IO-Link port	M12, A-coded, male		
No. of I/O ports	8		
Number of inputs	16 PNP		
Configurable	NC/NO		
Input status indicator	Yellow LED		
Total current $U_T$	max. 800 mA		
Degree of protection as per IEC 60529	IP 67 (when screwed into place)		
Operating temperature $T_a$	-5...+55 °C		
Storage temperature	-25...+70 °C		
Weight	Approx. 103 g		
Fastener	2 mounting holes		
Dimensions (L×W×H)	129.5×30×23.7 mm		
Housing material	Plastic		

IO-Link  
Product topology  
**M8 plastic IO-Link sensor hubs**  
M12 metal IO-Link sensor hubs  
M12 plastic IO-Link sensor hubs  
IO-Link sensor/actuator hubs  
M12 metal IO-Link actuator hubs  
IO-Link sensors  
IO-Link master  
Accessories

### IO-Link

No. of IO-Link ports	1× device		
Operating mode	COM 2		
IO-Link process data length	2 input bytes		
Indicators	Communication	Green LED, pulsing	
	Error	Red LED	
Parameter	NC/NO per input		

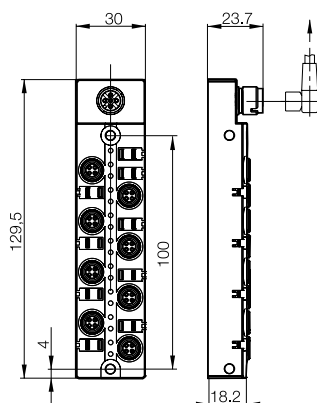

**Fast, detailed diagnostics on individual channels**

The lightweight, space-saving M8 sensor hubs with IO-Link port are also available with single-channel monitoring, which means that all the time and cost-saving benefits of IO-Link, including simple installation, central configuration and integrated diagnostics, are enhanced by this additional technical feature. The single-channel monitoring function provides detailed diagnostic results extremely fast. The single-channel monitoring function enables port-specific diagnostics of short circuits, overloading and cable breaks separately for each single channel. The diagnostic data is transferred with the process data, rendering acyclic services superfluous as a result. The extra benefit: Maximum diagnostic capability is achieved with minimal integration effort and diagnostics are performed in no time at all because the diagnostic data is included with the process data.



IO-Link Version	Device 4x DI	Device 8x DI
<b>Ordering code</b>	<b>BNI001W</b>	<b>BNI001Y</b>
Part number	BNI IOL-101-S01-K018	BNI IOL-102-S01-K019
Supply voltage $U_B$	18...30 V DC	18...30 V DC
Power-on indicator	Green LED	Green LED
Connection: I/O ports	M8, 3-pin, female	M8, 3-pin, female
Connection: IO-Link port	M12, A-coded, male	M12, A-coded, male
No. of I/O ports	4	8
Number of inputs	4 PNP	8 PNP
Configurable	NC/NO	NC/NO
Input status indicator	Yellow LED	Yellow LED
Total current $U_T$	max. 800 mA	max. 800 mA
Degree of protection as per IEC 60529	IP 67 (when screwed into place)	IP 67 (when screwed into place)
Operating temperature $T_a$	-5...+55 °C	-5...+55 °C
Storage temperature	-25...+70 °C	-25...+70 °C
Weight	Approx. 86 g	Approx. 103 g
Fastener	2 mounting holes	2 mounting holes
Dimensions (LxWxH)	85x30x23.7 mm	129.5x30x23.7 mm
Housing material	Plastic	Plastic

**IO-Link**

No. of IO-Link ports	1x device	1x device
Operating mode	COM 2	COM 2
IO-Link process data length	2 input bytes	2 input bytes
Indicators	Communication Green LED, pulsing	Green LED, pulsing
Error	Red LED	Red LED
Parameter	NC/NO per input	NC/NO per input

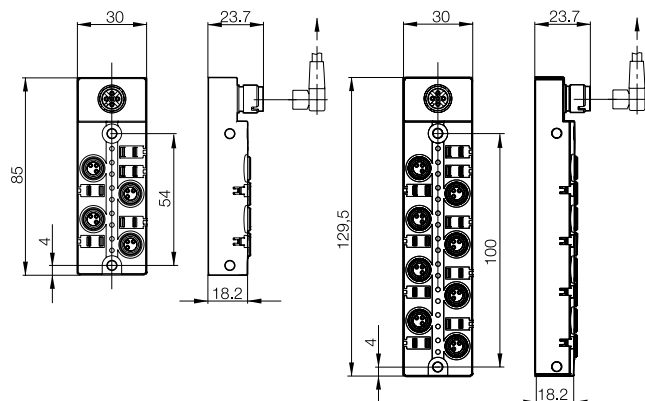

All hubs include four screw plugs and a label set.



# IO-Link

## M8 sensor hubs, IP 67, 4-pin, single-channel monitoring

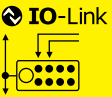

IO-Link  
Product topology  
**M8 plastic IO-Link sensor hubs**  
M12 metal IO-Link sensor hubs  
M12 plastic IO-Link sensor hubs  
IO-Link sensor/actuator hubs  
M12 metal IO-Link actuator hubs  
IO-Link sensors  
IO-Link master  
Accessories

IO-Link	Device		
Version	16x DI		
<b>Ordering code</b>	<b>BNI0022</b>		
Part number	BNI IOL-104-S01-K021		
Supply voltage $U_b$	18...30 V DC		
Power-on indicator	Green LED		
Connection: I/O ports	M8, 4-pin, female		
Connection: IO-Link port	M12, A-coded, male		
No. of I/O ports	8		
Number of inputs	16 PNP		
Configurable	NC/NO		
Input status indicator	Yellow LED		
Total current $U_T$	max. 800 mA		
Degree of protection as per IEC 60529	IP 67 (when screwed into place)		
Operating temperature $T_a$	-5...+55 °C		
Storage temperature	-25...+70 °C		
Weight	Approx. 103 g		
Fastener	2 mounting holes		
Dimensions (LxWxH)	129.5x30x23.7 mm		
Housing material	Plastic		

### IO-Link

No. of IO-Link ports	1x device		
Operating mode	COM 2		
IO-Link process data length	4 input bytes		
Indicators	Communication	Green LED, pulsing	
	Error	Red LED	
Parameter	NC/NO per input		

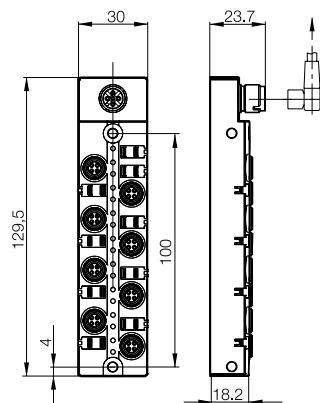

- Robust housing
- Powerful inputs
- Powerful outputs
- Extended temperature range

The metal sensor hubs in a robust housing are suitable for installation in extremely harsh industrial environments such as machine tool plants, steel works and so on. Based on M12 connectors, metal sensor hubs are simple to install and fulfill the requirements for cost-effective installation and maintenance.

Port-specific single-channel monitoring detects short circuits, overloading and cable breaks at the port and offers a completely unique degree of selective diagnostics for devices with this functionality. Each input can be programmed as normally closed or normally open using a parameter set, increasing the flexibility of your installation. Complementary DESINA sensors can also be connected to the DI16 sensor hub with ease.

The BNI IOL-302... version combines two modules in one while achieving the best functionality and flexibility. The maximum sensor load current is 500 mA, which is suitable for operating sensors with a high degree of consumption. If configured as an output, up to 2 A is available at the port. This is ideal for the use of hydraulic valves with a high consumption level.

**Clearly visible status LEDs**

Low-quality LEDs that are often difficult to identify under demanding production conditions perform poorly when used in high-speed applications. Unlike Balluff status LEDs, which are large, bright, highly visible and provide maximum assistance. Balluff quality will help you complete setup and maintenance tasks and reduce machine downtimes with ease.

**Powerful and safe outputs**

With an output current of up to **2 amps**, Balluff output modules are capable of driving almost any load. Each output also offers an overload protection with LED indicator and a memory feature for easy troubleshooting.

**Robust, full-metal housing**

The fully encapsulated housing can withstand impacts, shaking, corrosive fluids, as well as people stepping on it and costs the same as a plastic housing.

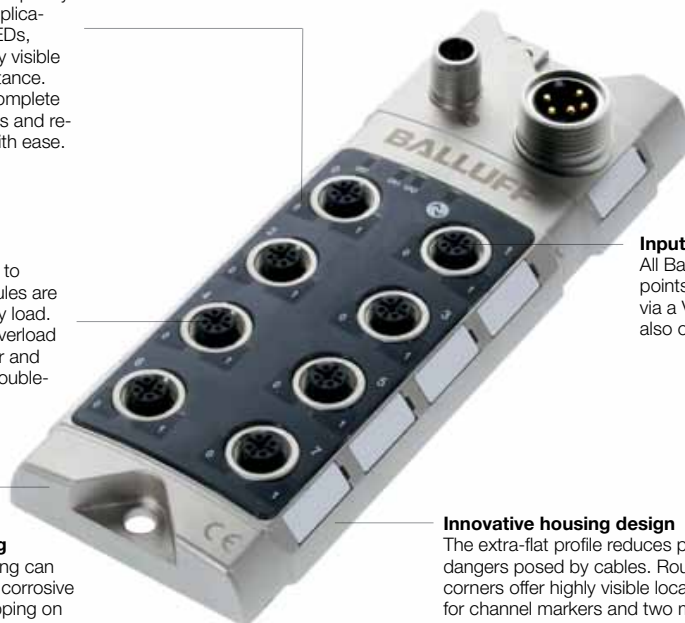

**Inputs with high density**

All Balluff input blocks offer two input points for each connector, accessed via a V splitter. A DESINA output is also optionally available via pin 2.

**Innovative housing design**

The extra-flat profile reduces potential dangers posed by cables. Rounded corners offer highly visible locations for channel markers and two mounting points are sufficient to secure the robust metal housing.



IO-Link	
Version	
<b>Ordering code</b>	
Part number	
Supply voltage $U_B$	
Function indicator IO-Link RUN	
Power-on indicator	
Connection: IO-Link	
Connection: I/O ports	
Connection $U_O$	
Connection $U_A$	
No. of I/O ports	
Number of inputs	
Number of outputs	
Configurable	
Single-channel monitoring	
Max. load current, sensors/channel	
Max. load current actuators/channel	
Port status indicator	
Total current $U_T$	
Total current $U_O$	
Degree of protection as per IEC 60529	
Operating temperature $T_a$	
Storage temperature	
Fastener	
Dimensions (LxWxH)	
Housing material	

**IO-Link**

No. of IO-Link ports	
Max. cycle time	
IO-Link process data length	
Indicators	Communication
	Error



NPN

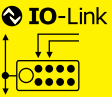

IO-Link  
Product topology  
M8 plastic IO-Link sensor hubs  
**M12 metal IO-Link sensor hubs**  
M12 plastic IO-Link sensor hubs  
IO-Link sensor/actuator hubs  
M12 metal IO-Link actuator hubs  
IO-Link sensors  
IO-Link master  
Accessories

Device	Device	Device	Device
16× DI	16× DI	16× DI/DO	16× DI/DO
<b>BNI0032</b>	<b>BNI0063</b>	<b>BNI003U</b>	<b>BNI0035</b>
BNI IOL-104-000-Z012	BNI IOL-106-000-Z012	BNI IOL-302-000-Z012	BNI IOL-302-000-Z013
18...30 V DC	18...30 V DC	18...30 V DC	18...30 V DC
Green LED	Green LED	Green LED	Green LED
Green LED	Green LED	Green LED	Green LED
M12, A-coded, male	M12, A-coded, male	M12, A-coded, male	M12, A-coded, male
M12, A-coded, female	M12, A-coded, female	M12, A-coded, female	M12, A-coded, female
via IO-Link interface	via IO-Link interface	via IO-Link interface	via IO-Link interface
8	8	8	8
16	16	max. 16	max. 16
No	No	Yes	Yes
No	Yes	No	No
100 mA	100 mA	100 mA	500 mA
		0.5 A	2 A
Yellow/red LED	Yellow/red LED	Yellow/red LED	Yellow/red LED
< 1.4 A	< 1.4 A	< 1.4 A	9 A
		< 1.4 A	9 A
IP 67 (when screwed into place)	IP 67 (when screwed into place)	IP 67 (when screwed into place)	IP 67 (when screwed into place)
-5...+70 °C	-5...+70 °C	-5...+70 °C	-5...+70 °C
-25...+70 °C	-25...+70 °C	-25...+70 °C	-25...+70 °C
2 mounting holes	2 mounting holes	2 mounting holes	2 mounting holes
181×68×36.9 mm	181×68×36.9 mm	181×68×36.9 mm	181×68×36.9 mm
Nickel-plated GdZn	Nickel-plated GdZn	Nickel-plated GdZn	Nickel-plated GdZn

1× device	1× device	1× device	1× device
2.5 ms	10 ms	10 ms	10 ms
2 input bytes	4 input bytes	2 input bytes/2 output bytes	2 input bytes/2 output bytes
Green LED, pulsing	Green LED, pulsing	Green LED, pulsing	Green LED, pulsing
Red LED	Red LED	Red LED	Red LED

All hubs include four screw plugs and a label set.

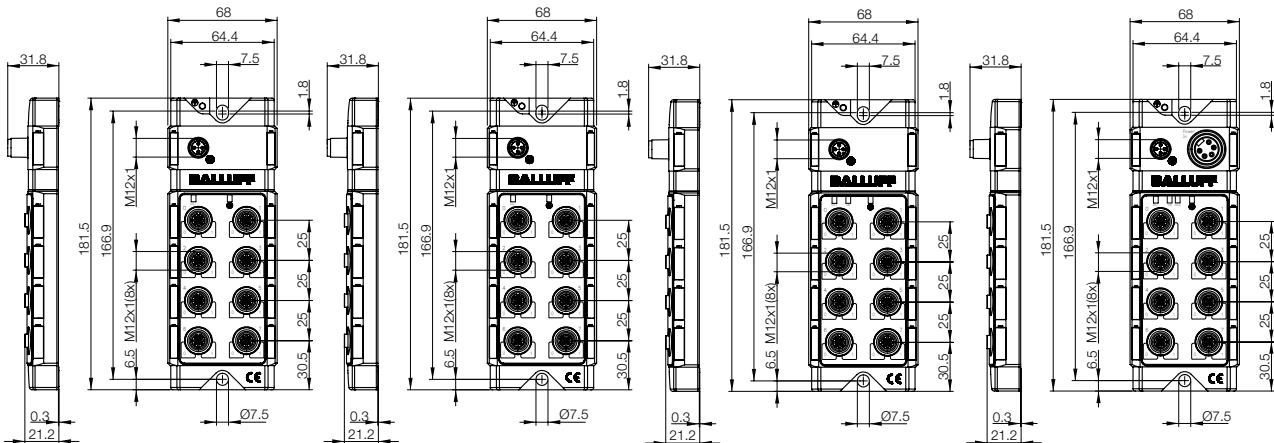

**Selectable IO-Link sensor hubs**

**Simple handling – lower costs – universal use**

Selectable IO-Link sensor hubs from Balluff are a market innovation. The user can write and read his own, user-defined identification data. They are, therefore, particularly economical when it is necessary to encode tools. In addition, they are easy to use.

**As an interface for interchangeable tools, they offer clearly calculable benefits:**

- Fast, cost-effective installation using 3-core unshielded cables
- Quick, reliable format changes
- Centrally available data for continuous process control
- Simple tool replacement with hub and data
- Speedy setup
- Simple encoding for new tools via controller

**Additional advantages**

- Universal sensor hub in IP 67
- Each hub has 16 inputs with single-channel monitoring
- Convenient LED display of power supply and function
- Detailed diagnostics (overload, short-circuit or cable break)
- Reduced downtimes

Selectable sensor hubs from Balluff represent lower costs, less work and reduced idle periods and ensure the highest efficiency.



selectable

IO-Link Version	Device 16× DI	Device 16× DI	
<b>Ordering code</b>	<b>BNI0039</b>	<b>BNI003T</b>	
Part number	BNI IOL-104-S01-Z012	BNI IOL-104-S01-Z012-C01	
Supply voltage $U_b$	18...30 V DC	18...30 V DC	
Function indicator IO-Link RUN	Green LED	Green LED	
Power-on indicator	Green LED	Green LED	
Connection: IO-Link	M12, A-coded, male	M12, A-coded, male	
Connection: I/O ports	M12, A-coded, female	M12, A-coded, female	
Connection $U_o$	via IO-Link interface	via IO-Link interface	
Connection $U_A$			
No. of I/O ports	8	8	
Number of inputs	16	16	
Number of outputs	0	0	
Configurable			
Single-channel monitoring	Yes	Yes	
Max. load current, sensors/channel	100 mA	100 mA	
Max. load current actuators/channel			
Port status indicator	Yellow/red LED	Yellow/red LED	
Total current $U_T$	< 1.4 A	< 1.4 A	
Total current $U_o$			
Degree of protection as per IEC 60529	IP 67 (when screwed into place)	IP 67 (when screwed into place)	
Operating temperature $T_a$	-5...+70 °C	-5...+70 °C	
Storage temperature	-25...+70 °C	-25...+70 °C	
Fastener	2 mounting holes	2 mounting holes	
Dimensions (L×W×H)	181×68×36.9 mm	181×68×36.9 mm	
Housing material	Nickel-plated GdZn	Nickel-plated GdZn	

**IO-Link**

Max. cycle time	10 ms	15 ms	
IO-Link process data length	4 input bytes	6 input bytes	
Indicators Communication	Green LED, pulsing	Green LED, pulsing	
Error	Red LED	Red LED	

All hubs include four screw plugs and a label set.

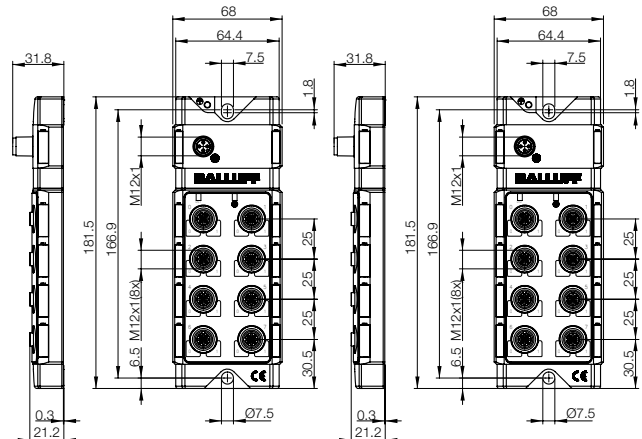



selectable

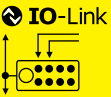

IO-Link  
Product topology  
M8 plastic IO-Link sensor hubs  
M12 metal IO-Link sensor hubs  
M12 plastic IO-Link sensor hubs  
IO-Link sensor/actuator hubs  
M12 metal IO-Link actuator hubs  
IO-Link sensors  
IO-Link master  
Accessories

Device	Device	Device	Device
16x DI/DO	16x DI/DO	16x DI/DO	16x DI/DO
<b>BNI003C</b>	<b>BNI005P</b>	<b>BNI003A</b>	<b>BNI0048</b>
BNI IOL-302-S01-Z012	BNI IOL-104-S01-Z012-C02	BNI IOL-302-S01-Z013	BNI IOL-302-S01-Z013-C01
18...30 V DC	18...30 V DC	18...30 V DC	18...30 V DC
Green LED	Green LED	Green LED	Green LED
Green LED	Green LED	Green LED	Green LED
M12, A-coded, male	M12, A-coded, male	M12, A-coded, male	M12, A-coded, male
M12, A-coded, female	M12, A-coded, female	M12, A-coded, female	M12, A-coded, female
via IO-Link interface	via IO-Link interface	via 7/8" connector	via 7/8" connector
via IO-Link interface	via IO-Link interface	via 7/8" connector	via 7/8" connector
8	8	8	8
max. 16	max. 16	max. 16	max. 16
max. 16	max. 16	max. 16	max. 16
Yes	Yes	Yes	Yes
Yes	Yes	Yes	Yes
100 mA	100 mA	500 mA	500 mA
0.5 A	0.5 A	2 A	2 A
Yellow/red LED	Yellow/red LED	Yellow/red LED	Yellow/red LED
< 1.4 A	< 1.4 A	9 A	9 A
< 1.4 A	< 1.4 A	9 A	9 A
IP 67 (when screwed into place)	IP 67 (when screwed into place)	IP 67 (when screwed into place)	IP 67 (when screwed into place)
-5...+70 °C	-5...+70 °C	-5...+70 °C	-5...+70 °C
-25...+70 °C	-25...+70 °C	-25...+70 °C	-25...+70 °C
2 mounting holes	2 mounting holes	2 mounting holes	2 mounting holes
181x68x36.9 mm	181x68x36.9 mm	181x68x36.9 mm	181x68x36.9 mm
Nickel-plated GdZn	Nickel-plated GdZn	Nickel-plated GdZn	Nickel-plated GdZn
25 ms	25 ms	25 ms	30 ms
8 input bytes/2 output bytes	8 input bytes/2 output bytes	8 input bytes/2 output bytes	10 input bytes/2 output bytes
Green LED, pulsing	Green LED, pulsing	Green LED, pulsing	Green LED, pulsing
Red LED	Red LED	Red LED	Red LED

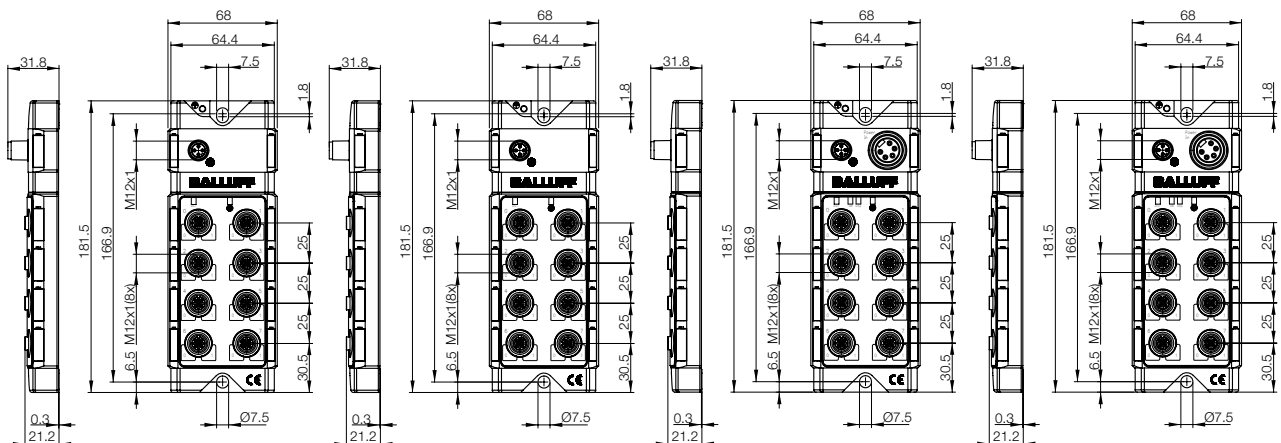

- Robust housing
- Powerful inputs
- Powerful outputs
- Extended temperature range
- Modules with reliable deactivation mechanism

If you wish to depict standard I/Os or safety I/Os in a fieldbus topology, the issue of safety becomes increasingly important for network/system integration.

Type BNI IOL-252/256 IO-Link actuator hubs fulfill requirements relating to the "passive safety" of outputs following safe deactivation in accordance with Machinery Directive 2006/42/EC, EN 954-1 category 3, EN 13849-1, EN 62061 SIL2.

The I/O block is divided into two galvanically isolated segments in order that two separately switching safety circuits can be implemented using one module.

The functions of the IO-Link system concept are extended considerably as a result. The IO-Link fulfills the requirements for a holistic approach and simultaneously reduces the number of components and guarantees simpler installation.

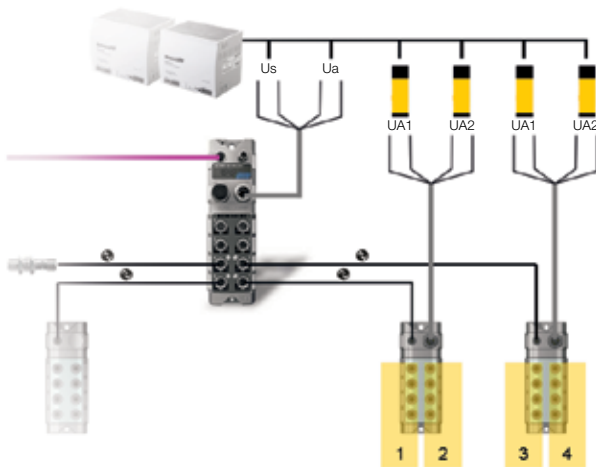

IO-Link	
Version	
<b>Ordering code</b>	
Part number	
Supply voltage $U_b$	
Function indicator IO-Link RUN	
Power-on indicator	
Connection: IO-Link	
Connection: I/O ports	
Connection $U_o$	
Connection $U_a$	
No. of I/O ports	
Number of outputs	
Configurable	
Single-channel monitoring	
Number of output circuits	
Outputs per output circuit	
Single-channel monitoring	
Max. load current, sensors/channel	
Max. load current actuators/channel	
Port status indicator	
Total current $U_T$	
Total current $U_o$	
Degree of protection as per IEC 60529	
Operating temperature $T_a$	
Storage temperature	
Fastener	
Dimensions (LxWxH)	
Housing material	

<b>IO-Link</b>	
Max. cycle time	
IO-Link process data length	
Indicators	Communication
	Error

**All hubs include four screw plugs and a label set.**

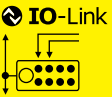

IO-Link  
Product topology  
M8 plastic IO-Link sensor hubs  
M12 metal IO-Link sensor hubs  
M12 plastic IO-Link sensor hubs  
IO-Link sensor/actuator hubs  
**M12 metal IO-Link actuator hubs**  
IO-Link sensors  
IO-Link master  
Accessories

Device	Device	Device	Device
2x 4xDO	2x 4xDO	2x 8xDO	2x 8xDO
<b>BNI0033</b>	<b>BNI0034</b>	<b>BNI003W</b>	<b>BNI003Y</b>
BNI IOL-252-000-Z013	BNI IOL-256-000-Z013	BNI IOL-252-S01-Z013	BNI IOL-256-S01-Z013
18...30 V DC	18...30 V DC	18...30 V DC	18...30 V DC
Green LED	Green LED	Green LED	Green LED
Green LED	Green LED	Green LED	Green LED
M12, A-coded, male	M12, A-coded, male	M12, A-coded, male	M12, A-coded, male
M12, A-coded, female	M12, A-coded, female	M12, A-coded, female	M12, A-coded, female
via 7/8" connector	via 7/8" connector	via 7/8" connector	via 7/8" connector
via 7/8" connector	via 7/8" connector	via 7/8" connector	via 7/8" connector
8	8	8	8
8	16	8	16
No	No	No	No
No	No	Yes	Yes
2	2	2	2
4	8	4	8
No	No	Yes	Yes
2 A	2 A	2 A	2 A
Yellow/red LED	Yellow/red LED	Yellow/red LED	Yellow/red LED
9 A	9 A	9 A	9 A
9 A	9 A	9 A	9 A
IP 67 (when screwed into place)	IP 67 (when screwed into place)	IP 67 (when screwed into place)	IP 67 (when screwed into place)
-5...+70 °C	-5...+70 °C	-5...+70 °C	-5...+70 °C
-25...+70 °C	-25...+70 °C	-25...+70 °C	-25...+70 °C
2 mounting holes	2 mounting holes	2 mounting holes	2 mounting holes
181x68x36.9 mm	181x68x36.9 mm	181x68x36.9 mm	181x68x36.9 mm
Nickel-plated GdZn	Nickel-plated GdZn	Nickel-plated GdZn	Nickel-plated GdZn

2.5 ms	5 ms	15 ms	20 ms
1 output byte	2 output byte	3 input bytes/1 output byte	5 input bytes/2 output bytes
Green LED, pulsing	Green LED, pulsing	Green LED, pulsing	Green LED, pulsing
Red LED	Red LED	Red LED	Red LED

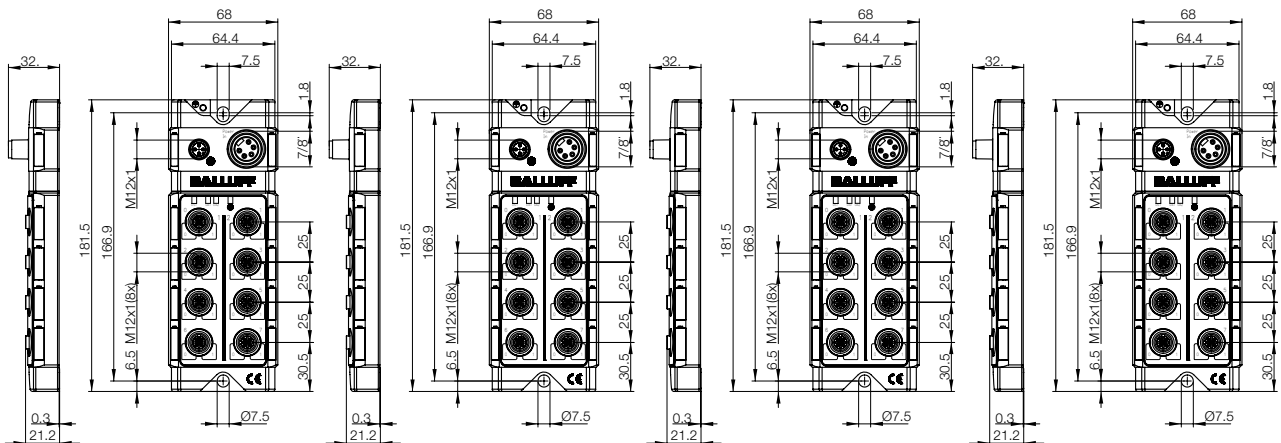





**NPN**

IO-Link	Device	Device	Device
Version	8× DI	16× DI	16× DI
<b>Ordering code</b>	<b>BNI0005</b>	<b>BNI0006</b>	<b>BNI0074</b>
Part number	BNI IOL-102-000-K006	BNI IOL-104-000-K006	BNI IOL-106-000-K006
Supply voltage $U_b$	18...30 V DC	18...30 V DC	18...30 V
Function indicator IO-Link RUN	Green LED	Green LED	Green LED
Power-on indicator	Green LED	Green LED	Green LED
Connection: IO-Link	M12, A-coded, male	M12, A-coded, male	M12, A-coded, male
Connection: I/O ports	M12, A-coded, female	M12, A-coded, female	M12, A-coded, female
No. of I/O ports	8	8	8
Number of inputs	8 PNP	16 PNP	16 NPN
Configurable/parameterizable	No	No	NC/NO
Max. load current, sensors/channel	100 mA	100 mA	200 mA
Port status indicator	Yellow LED	Yellow LED	Yellow LED
Total current $I_T$	< 1.2 A	< 1.2 A	< 1.2 A
Degree of protection as per IEC 60529	IP 67 (when screwed into place)	IP 67 (when screwed into place)	IP 67 (when screwed into place)
Operating temperature $T_a$	-5...+55 °C	-5...+55 °C	-5...+55 °C
Storage temperature	-25...+85 °C	-25...+85 °C	-25...+85 °C
Weight	Approx. 86 g	Approx. 86 g	
Fastener	3 mounting holes	3 mounting holes	3 mounting holes
Dimensions (L×W×H)	115×50×31 mm	115×50×31 mm	115×50×31 mm
Housing material	Trogamid	Trogamid	PC

**IO-Link**

No. of IO-Link ports	1× device	1× device	1× device
Max. cycle time	3 ms	3 ms	3 ms
IO-Link process data length	2 input bytes	2 input bytes	2 input bytes
Indicators	Communication	Green LED	Green LED
	Error	Red LED	Red LED

**All hubs include four screw plugs and a label set.**

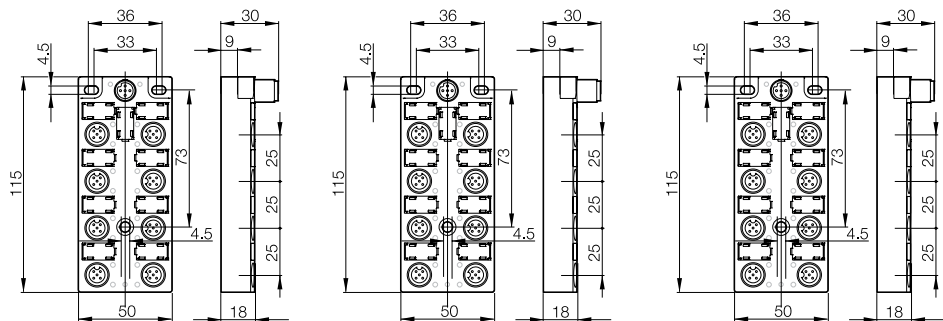

The sensor hub is a particularly efficient complement to your machine installation. You can conveniently connect standard sensors using 8 or 16 standard inputs.

Each input can be programmed as normally closed or normally open using a parameter set. to increase the flexibility of your installation.

Complementary DESINA sensors can be easily connected to the DI16 sensor hub.

Communication with the IO-Link master takes place in COM2 mode (38.4 kbaud) on the standard 3-conductor cable and gives you a complete process representation in as little as 2 ms.



# IO-Link

## M12 sensor hubs, IP 67, 4-pin Analog

With the analog sensor hub, you can select from two additional variants with current and voltage interface, allowing you to connect non-IO-Link capable sensors with maximum reliability. Four existing analog channels can be supplemented with four additional dual-use standard input ports per IEC 61131. The analog channels have a resolution of 10 bits.

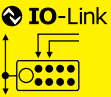

IO-Link  
Product topology  
M8 plastic sensor hubs  
M12 metal IO-Link sensor hubs  
M12 plastic IO-Link sensor hubs  
IO-Link sensor/actuator hubs  
M12 metal IO-Link actuator hubs  
IO-Link sensors  
IO-Link master  
Accessories

IO-Link Version	Device	Device
Ordering code	<b>BNI0007</b>	<b>BNI0008</b>
Part number	BNI IOL-709-000-K006	BNI IOL-710-000-K006
Supply voltage $U_B$	18...30 V DC	18...30 V DC
Function indicator IO-Link RUN	Green LED	Green LED
Power-on indicator	Green LED	Green LED
Connection: IO-Link	M12, A-coded, male	M12, A-coded, male
Connection: I/O ports	M12, A-coded, female	M12, A-coded, female
No. of I/O ports	8	8
Number of digital inputs	8 PNP	8 PNP
Configurable	NC/NO	NC/NO
Max. load current, sensors/channel	200 mA	200 mA
Port status indicator	Yellow LED	Yellow LED
Total current $U_T$	< 1.2 A	< 1.2 A
Degree of protection as per IEC 60529	IP 67 (when screwed into place)	IP 67 (when screwed into place)
Operating temperature $T_a$	-5...+55 °C	-5...+55 °C
Storage temperature	-25...+85 °C	-25...+85 °C
Weight	Approx. 86 g	Approx. 86 g
Fastener	3 mounting holes	3 mounting holes
Dimensions (LxWxH)	115x50x31 mm	115x50x31 mm
Housing material	Trogamid	Trogamid

### Analog ports

Number of analog ports	4	4
Interface	4...20 mA	0...10 V DC
Resolution	10 bit	10 bit
Analog signal indicator	Green LED	Green LED

### IO-Link

No. of IO-Link ports	1x device	1x device
Operating mode	COM 2 (3-wire)	COM 2 (3-wire)
IO-Link process data length	10 input bytes	10 input bytes
Indicators	Communication	Green LED
	Error	Red LED
Max. load current	< 1.2 A	< 1.2 A
Parameter	NC/NO per input, 1 switching point per analog channel	NC/NO per input, 1 switching point per analog channel

All hubs include four screw plugs and a label set.

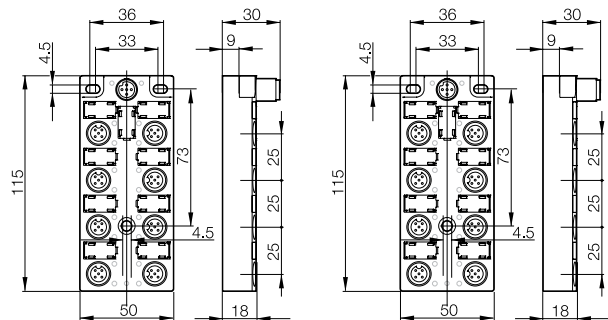

- Every port can be freely configured and used as an output or input
- Inputs can be programmed as normally closed or normally open, depending on requirements, via the configuration
- Max. load current 350 mA per port
- Max. load current 1.2 A overall
- Connected to a 1.1 IO-Link master, they provide full 1.1 functionality, such as data storage and an expanded data frame

**Simple handling, fast data, four variants**

Space-saving M12 sensor hubs with IO-Link interface are the first choice wherever space is limited, because they provide up to 16 inputs in the tightest of spaces. And their low weight makes them recommended for weight-critical applications.

M12 sensor hubs are easy to install and save time, because a simple 3-pin standard cable is sufficient for the connection. M12 sensor hubs are time and cost saving, even during maintenance and in system operation.

This is because, like all IO-Link products, they ensure consistent diagnostics and can be configured centrally. M12 sensor hubs are also particularly fast. Sending 16 sensor signals, for example, takes 2.5 ms. This ensures that the controller always receives current information. Each individual channel can be programmed to function as normally closed (NC) or normally open (NO), which allows the connection of complementary sensors (DESINA).

M12 sensor hubs with IO-Link port are available in four variants.

**M12 plastic sensor hubs now also have output functionality**

The maximum 16 channels of the M12 plastic sensors are freely configurable (input/output) and fulfill the requirements according to cost-effective, flexible wiring. IO-Link 1.1 is connected using a 4-pin standard sensor cable.



IO-Link	
Description	
Version	
<b>Ordering code</b>	
Part number	
Supply voltage $U_B$	
Function indicator IO-Link RUN	
Power-on indicator	
Connection: IO-Link	
Connection: I/O ports	
Connection $U_O$	
Connection $U_A$	
No. of I/O ports	
Number of inputs	
Number of outputs	
Configurable	
Single-channel monitoring	
Codeable via IO-Link	
Max. load current, sensors/channel	
Max. load current actuators/channel	
Port status indicator	
Total current $U_T$	
Total current $U_O$	
Degree of protection as per IEC 60529	
Operating temperature $T_a$	
Storage temperature	
Fastener	
Dimensions (LxWxH)	
Housing material	

**IO-Link Version 1.1**

Max. cycle time	
IO-Link process data length	
Indicators	Communication Error

**All hubs include four screw plugs and a label set.**

# IO-Link

## M12 sensor hubs, configurable

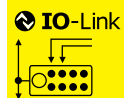

IO-Link  
Product topology  
M8 plastic IO-Link sensor hubs  
M12 metal IO-Link sensor hubs  
**M12 plastic IO-Link sensor hubs**  
IO-Link sensor/actuator hubs  
M12 metal IO-Link actuator hubs  
IO-Link sensors  
IO-Link master  
Accessories

Device	Device	Device	Device
Standard module	Single-channel diagnostics	selectable	Single-channel diagnostics and codeable
16× DI/DO	16× DI/DO	16× DI/DO	16× DI/DO
<b>BNI005L</b>	<b>BNI005T</b>	<b>BNI005U</b>	<b>BNI005W</b>
BNI IOL-302-000-K006	BNI IOL-302-S01-K006	BNI IOL-302-000-K006-C01	BNI IOL-302-S01-K006-C01
18...30 V	18...30 V	18...30 V	18...30 V
Green LED	Green LED	Green LED	Green LED
Green LED	Green LED	Green LED	Green LED
M12, A-coded, male	M12, A-coded, male	M12, A-coded, male	M12, A-coded, male
M12, A-coded, female	M12, A-coded, female	M12, A-coded, female	M12, A-coded, female
via IO-Link interface	via IO-Link interface	via IO-Link interface	via IO-Link interface
via IO-Link interface	via IO-Link interface	via IO-Link interface	via IO-Link interface
8	8	8	8
16 max.	16 max.	16 max.	16 max.
16 max.	16 max.	16 max.	16 max.
Yes	Yes	Yes	Yes
No	Yes	No	Yes
No	No	Yes	Yes
100 mA	100 mA	100 mA	100 mA
0.35 A	0.35 A	0.35 A	0.35 A
Yellow/red LED	Yellow/red LED	Yellow/red LED	Yellow/red LED
< 1.3 A	< 1.3 A	< 1.3 A	< 1.3 A
< 1.6 A	< 1.6 A	< 1.6 A	< 1.6 A
IP 67	IP 67	IP 67	IP 67
-5...+55 °C	-5...+55 °C	-5...+55 °C	-5...+55 °C
-25...+70 °C	-25...+70 °C	-25...+70 °C	-25...+70 °C
2 mounting holes	2 mounting holes	2 mounting holes	2 mounting holes
115×50×31	115×50×31 mm	115×50×31 mm	115×50×31 mm
PC	PC	PC	PC

3.5 ms	5 ms	4 ms	5.5 ms
2 byte input/2 byte output	8 byte input/2 byte output	4 byte input/2 byte output	10 byte input/2 byte output
Green LED	Green LED	Green LED	Green LED
Red LED	Red LED	Red LED	Red LED

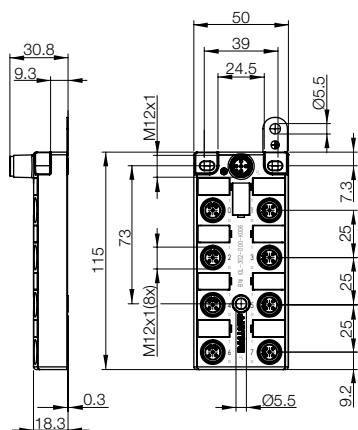
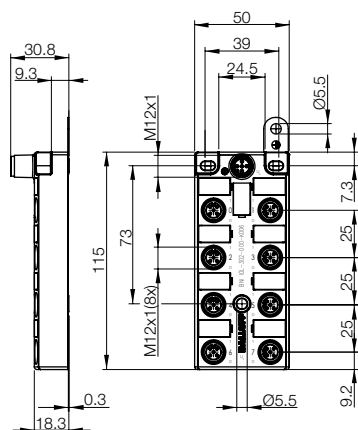

### Easy installation with IO-Link under IP 20 conditions

The maximum 16 channels of the IP 20 IO-Link sensor/actuator hub are user-configurable (input/output) and meet the requirements for inexpensive flexible wiring.

The IO-Link is connected with a 4-pin standard sensor cable. The connection from/to the peripherals is by means of removable screw terminal blocks.

### IO-Link up to the control panel

The compact size enables the simple and straightforward installation in control cabinets, control boxes and control panel housings.

Simply snap the plastic housing onto a mounting rail according to EN 60175 – done.

### IO-Link for integration in devices and device modules

Circuit board variants are available for the integration in spatially limited and complex functional units which can be integrated via spacing bolts.

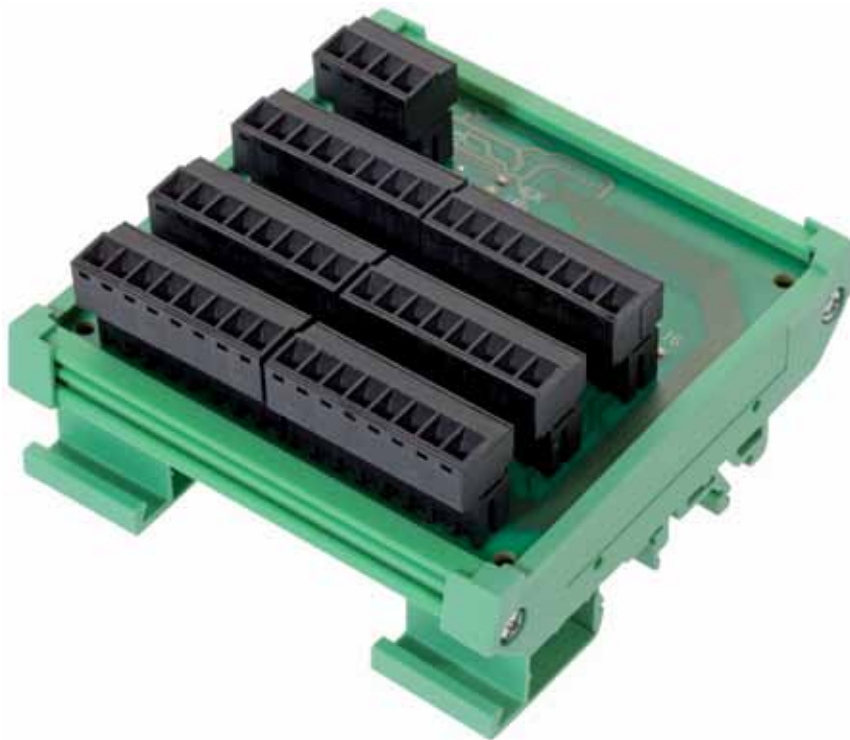

# IO-Link

## Sensor/actuator hubs, IP 20

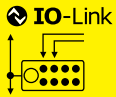

IO-Link  
Product topology  
M8 plastic IO-Link sensor hubs  
M12 metal IO-Link sensor hubs  
M12 plastic IO-Link sensor hubs  
IO-Link sensor/actuator hubs  
M12 metal IO-Link actuator hubs  
IO-Link sensors  
IO-Link master  
Accessories

IO-Link Version	Device	Device
Ordering code	<b>BNI004K</b>	<b>BNI004L</b>
Part number	BNI IOL-309-000-K024	BNI IOL-310-000-K025
Supply voltage $U_B$	18...30 V DC	18...30 V DC
Function indicator IO-Link RUN	Green LED	Green LED
Power-on indicator	Green LED	Green LED
Connection: IO-Link	Spring force or screw terminals, plug-in	Spring force or screw terminals, plug-in
Connection $U_O$	Spring force or screw terminals, plug-in	Spring force or screw terminals, plug-in
Connection $U_A$	Spring force or screw terminals, plug-in	Spring force or screw terminals, plug-in
Connection: I/O ports	Spring force or screw terminals, plug-in	Spring force or screw terminals, plug-in
No. of I/O ports	8	16
Number of inputs	Max. 8	Max. 16
Number of outputs	Max. 8	Max. 16
Configurable/parameterizable	Yes	Yes
Single-channel monitoring	No	No
Max. load current, sensors/channel	100 mA	100 mA
Max. load current actuators/channel	400 mA	400 mA
Port status indicator	Yellow LED	Yellow LED
Total current $U_T$	< 1.4 A	< 1.4 A
Total current $U_O$	< 1.4 A	< 1.4 A
Degree of protection as per IEC 60529	IP 20	IP 20
Operating temperature $T_a$	-5...+50 °C	-5...+50 °C
Storage temperature	-25...+75 °C	-25...+75 °C
Fastener	Top-hat rail fitting over plastic shell	Top-hat rail fitting over plastic shell
Dimensions (LxWxH)	49x84x43 mm	79x84x43 mm

IO-Link		
No. of IO-Link ports	1x device	1x device
Max. cycle time	3 ms	12 ms
IO-Link process data length	1 input byte/1 output byte	2 input bytes/2 output bytes
Indicators	Communication	Green LED, pulsing
	Error	Red LED

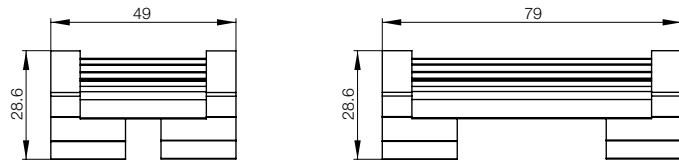

### Accessories:

Screw terminals		
for	Ordering code	<b>BAM01ZF</b>
BNI004K	Part number	BAM IA-NI-008-K024
for	Ordering code	<b>BAM01ZH</b>
BNI004L	Part number	BAM IA-NI-008-K025
Spring terminals		
for	Ordering code	<b>BAM01ZI</b>
BNI004K	Part number	BAM IA-NI-010-K024
for	Ordering code	<b>BAM01ZK</b>
BNI004L	Part number	BAM IA-NI-010-K025

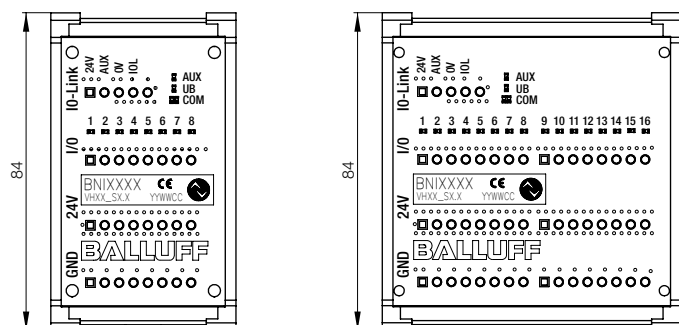

# IO-Link

## Fork sensors BGL

### In-process correction

Thanks to their band of light, fork sensors BGL can detect objects with absolute reliability while determining their position with pin-point accuracy. In-process correction is simplified substantially. Process reliability and product quality are significantly improved, thereby increasing efficiency.

### Technical highlights

- Analog signal proportional to the skin depth of the object
- Constant value, even in the event of height variations
- Fieldbus connection with IO-Link

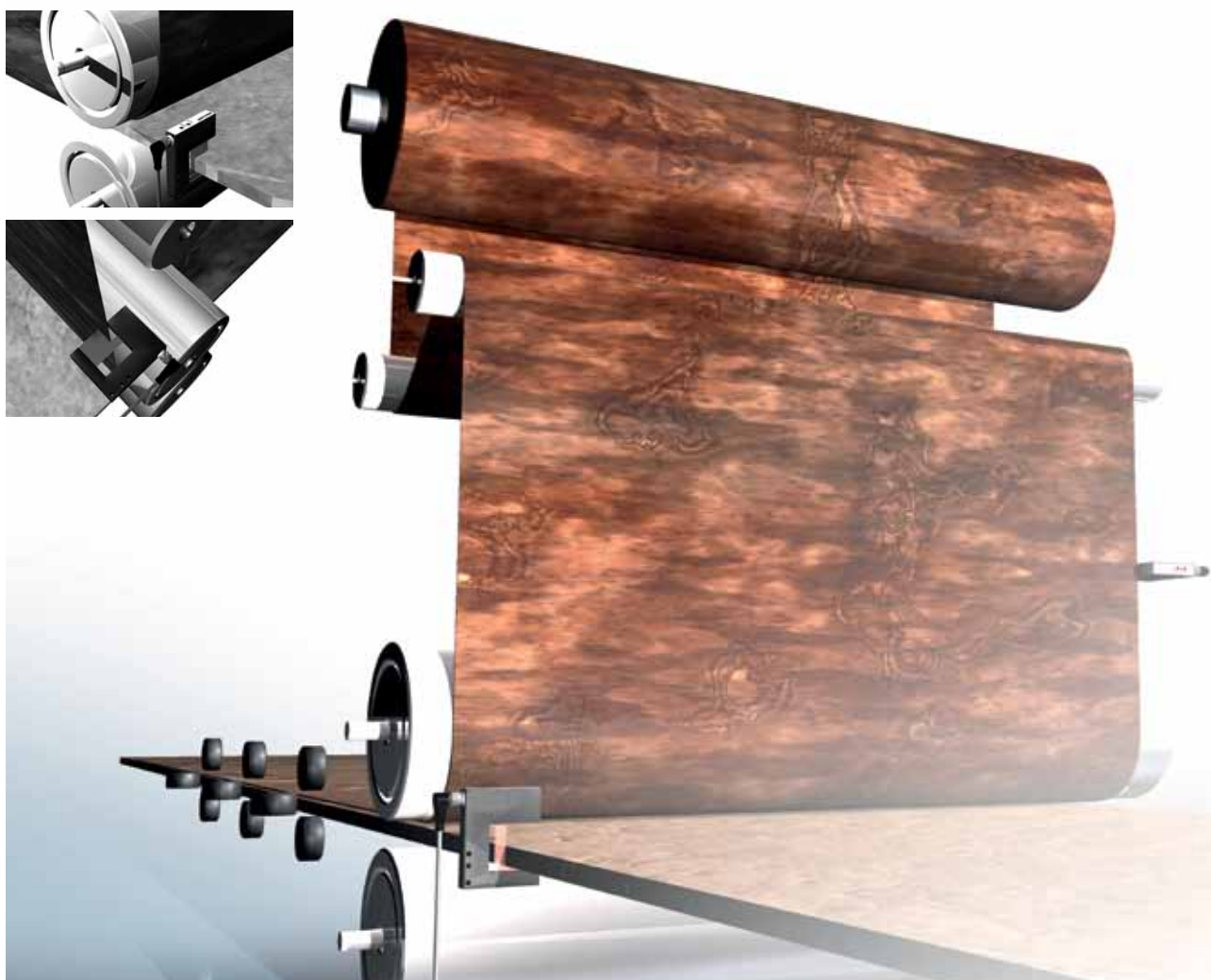

# IO-Link Fork sensors BGL

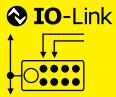

IO-Link  
Product topology  
M8 plastic IO-Link sensor hubs  
M12 metal IO-Link sensor hubs  
M12 plastic IO-Link sensor hubs  
IO-Link sensor/actuator hubs  
M12 metal IO-Link actuator hubs  
**IO-Link sensors**  
IO-Link master  
Accessories

Series	<b>BGL Series C Premium</b>		<b>BGL Series C Premium</b>
Output signal	<b>IO-Link</b>		<b>IO-Link</b>
Fork opening	<b>30 mm</b>		<b>50 mm</b>
Measurement field length	25 mm		25 mm
PNP	<b>Ordering code</b>	<b>BGL0035</b>	<b>BGL003F</b>
	Part number	BGL 30C-007-S4	BGL 50C-007-S4
Supply voltage $U_B$	18...30 V DC		18...30 V DC
No-load supply current $I_0$ max.	≤ 20 mA		≤ 20 mA
Output current	Max. 100 mA per output		Max. 100 mA per output
LED indicators	2 x yellow LED		2 x yellow LED
Response time	≤ 1 ms		≤ 1 ms
Settings	2x teach button		2x teach button
Switching frequency $f$	500 Hz		500 Hz
Light type	Red light 633 nm		Red light 633 nm
Resolution	0.1 mm		0.1 mm
Repeat accuracy	0.25 mm		0.25 mm
Hysteresis	±0.8%		±0.8%
Connection	M12, 4-pin, A-coded		M12, 4-pin, A-coded
Housing material	Anodized aluminum		Anodized aluminum
Weight	155 g		175 g
Degree of protection as per IEC 60529	IP 67		IP 67
Polarity reversal protected	Yes		Yes
Short-circuit protected	Yes		Yes
Ambient temperature $T_a$	-5...+55 °C		-5...+55 °C
Permissible ambient light	≤ 1 klx		≤ 1 klx

<b>IO-Link</b>		
Mode	COM 2	COM 2
Transfer rate	38.4 kbaud	38.4 kbaud
IO-Link process data length	2 input bytes	2 input bytes
Value range	000 H...03FF H	000 H...03FF H
Diagnostics	Contamination	Contamination
Parameter	Switching points/switching range, button disable, NO/NC switch, analog value characteristics	Switching points/switching range, button disable, NO/NC switch, analog value characteristics

Integral air rinsing nozzles to prevent dust from accumulating on the emitter and receiver optics. Simple connection via standard pneumatic system.

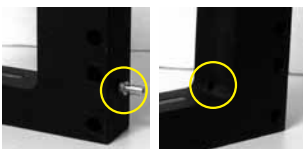
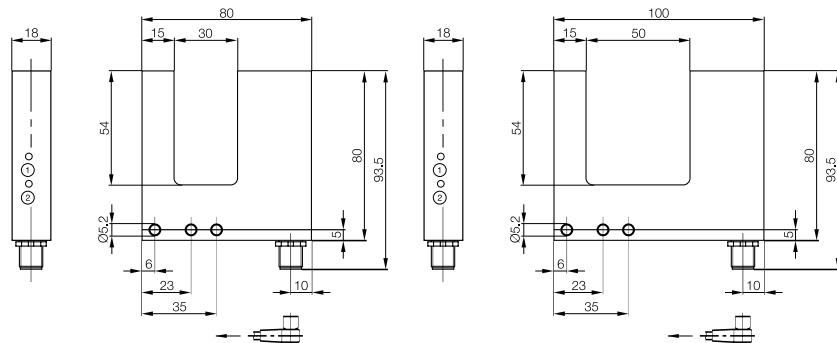



# IO-Link

## Color sensor BFS 26K

Robotics, automation, quality assurance and production processes are among the applications for color sensors. The color sensor **BFS 26K** is suitable for

- Quality assurance
- Selection of components
- Detection of cable wires

The BFS 26K uses white light and is especially insensitive to ambient light. This provides you with reliable data in challenging applications. Making your setting is incredibly easy since the controller handles data configuration via IO-Link.



Series	<b>BFS 26K</b>	
Output signal	<b>IO-Link</b>	
Working range	Key operation	12...32 mm
Measuring range	Reflector mode	50...200 mm
PNP	<b>Ordering code</b>	<b>BFS000F</b>
	Part number	BFS 26K-GI-L04-S92
Supply voltage $U_B$	12...28 V DC	
Residual ripple	10%	
No-load supply current $I_0$ max.	≤ 40 mA	
Switching output	3×PNP transistor	
Output current	100 mA	
Switching type	Light switching	
Voltage drop $U_d$ at $I_e$	≤ 2.4 V	
Settings	Teach-in	
Emitter, light type	Pulsed white light	
Light spot geometry	Round	
Light spot diameter	Ø 4 mm at sensing distance 22 mm	
Sensing distance tolerance	±6 mm at Tol. 3	
Color resolution tolerance	Adjustable in 5 levels	
Power-on indicator	Green LED	
Output function indicator Ch. 1...Ch. 3	3×Yellow LED	
Output function indicator Tol. 1...Tol. 5	3×Red LED	
Ready delay	300 ms	
Response time	1 ms	
Switching frequency $f$	500 Hz	
Time functions	50 ms turn-off delay, switchable	
Dimensions	50×50×17 mm	
Connection	M12 connector, 4-pin	
Housing material	Impact-resistant ABS	
Optical surface	PMMA	
Weight	40 g	
Degree of protection as per IEC 60529	IP 67	
Polarity reversal protected	Yes	
Short-circuit protected	Yes	
Ambient temperature $T_a$	-10...+55 °C	
Ambient light limit according to	EN 60947-5-2	

### IO-Link

Mode	COM 2
Transfer rate	38.4 kbaud
IO-Link process data length	2 input bytes
Parameter	Max. 5 colors, 5 tolerance ranges, NC/NO, button disable

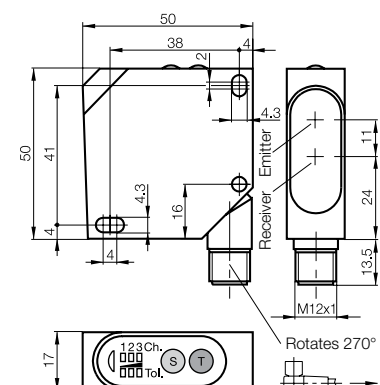



# IO-Link

## Laser distance sensor BOD 63 M

When traditional sensing methods reach their technological and economic limits, laser distance sensors **BOD 63M** step in:

- For detecting small objects over long distances
- In difficult environments, such as high temperatures
- In robot cells

The BOD 63M with rugged metal housing has a working range of 200...6000 mm. Its data is transmitted via IO-Link mode, which makes setup and operation extremely easy: two teach-in buttons are provided for initiating startup. You can set both switching points directly from the controller, deactivate the laser and disable the buttons.

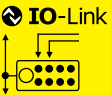
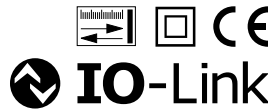

Series	<b>BOD 63M</b>
Output signal	<b>IO-Link</b>
Working range	200...6000 mm
Measuring range	5800 mm
PNP	<b>Ordering code</b>
	Part number
	<b>BOD0012</b>
	BOD 63M-LI06-S4
Supply voltage $U_B$	18...30 V DC
No-load supply current $I_0$ max.	90 mA
Settings	Teach-in
Switching points	2
Emitter, light type	Laser, red light
Wavelength	660 nm
Laser class	2
Light spot diameter	5 mm at 3 m 10 mm at 6 m
Resolution	1 mm
Gray value shift	≤ <b>1.5%</b>
Repeat accuracy	≤ ±4 mm
Temperature drift	≤ 1.5 mm/K
Max. characteristic deviation	± 1% of $W_h$
Switching hysteresis (in % of $S_i$ )	0.3%
On/off delay	≤ 3.3 ms
Ready delay	≤ 20 ms
Switching frequency $f$	≤ 150 Hz
Power-on indicator	Green LED
Output function indicator	Yellow LED
Stability indicator	Red LED
Dimensions	90×70×35 mm
Connection	M12 connector, 4-pin
Housing material	Anodized aluminum
Optical surface	Glass
Weight	270 g
Degree of protection as per IEC 60529	IP 65
Polarity reversal protected	Yes
Short-circuit protected	Yes
Ambient temperature $T_a$	-10...+60 °C
Permissible ambient light	≤ 10 klx

IO-Link  
Product topology  
M8 plastic IO-Link sensor hubs  
M12 metal IO-Link sensor hubs  
M12 plastic IO-Link sensor hubs  
IO-Link sensor/actuator hubs  
M12 metal IO-Link actuator hubs  
**IO-Link sensors**  
IO-Link master  
Accessories

### IO-Link

Mode	COM 2
Transfer rate	38.4 kbaud
IO-Link process data length	3 input bytes/1 output byte
Value range analog	00C8 H...1770 H for Wl...Wh
Diagnostics	Stability indicator
Parameter	Switching points, laser on/off, button disable

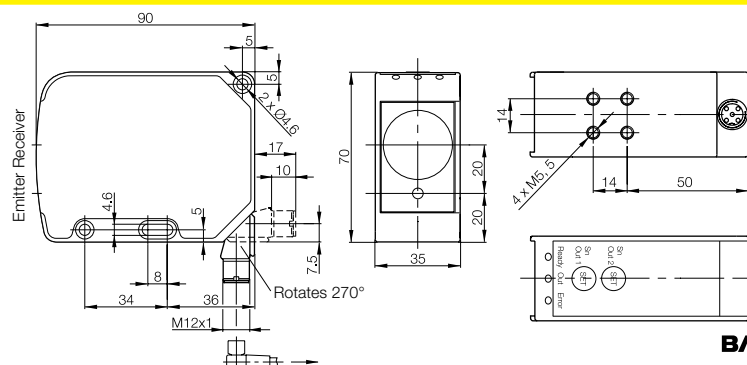

# IO-Link

## Inductive distance sensor

### BAW M18

Our inductive distance sensors can detect positions, distances and material variations with incredible ease.

#### Applications

- Distance sensing (even at high speeds)
- Measurement of film and sheet thicknesses
- Belt center measurement
- Measurement of metal strip widths
- Detection of surface waves
- Counting tasks
- Positioning
- Position checking
- Clamping status detection
- Selection of different sizes and materials

#### Features

- Contactless and absolute measuring principle
- Distance-proportional IO-Link output signal
- High repeat accuracy
- Optimal linearity
- Low temperature drift
- Measuring speed up to 40 m/s
- LED for indicating the working range
- Insensitive to contamination



Size	<b>M18x1</b>
Output signal	<b>IO-Link</b>
Installation type	Flush
Linear range $s_l$	1...5 mm
<b>Ordering code</b>	<b>BAW002F</b>
Part number	BAW M18MI-BLC50B-S04G
Supply voltage $U_B$	18...30 V DC
Residual ripple	$\leq 15\%$ of $U_B$
Rated insulation voltage $U_i$	250 V AC
Effective distance $s_e$	3 mm
Load resistance $R_L$	$\leq 2 \text{ k}\Omega$
Load resistance $R_T$	
No-load supply current $I_0$ at $U_B$	$\leq 10 \text{ mA}$
Polarity reversal protected	Yes
Short-circuit protected	Yes
Ambient temperature $T_a$	$-10...+70 \text{ }^\circ\text{C}$
Repeat accuracy $R_{BWN}$	$\pm 8 \text{ }\mu\text{m}$
Non-linearity	$\leq \pm 120 \text{ }\mu\text{m}$
Measuring speed	$\leq 40 \text{ m/s}$
Response time	2 ms
Temperature coefficient TC	Typical
In the optimum range	Min.
From $+10...+50 \text{ }^\circ\text{C}$	Max.
Degree of protection as per IEC 60529	IP 67
Housing material	Nickel-plated CuZn
Material of sensing face	PBT
Connection	Connector
Recommended connector	BCCM415/BCCM425
Display	Out of range

#### IO-Link

Mode	COM 2
Transfer rate	38.4 kbaud
IO-Link process data length	2 input bytes
Value range	0000 H...03FF H

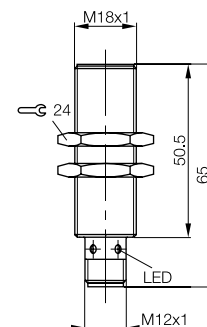

# IO-Link

## Inductive distance sensor

### BAW Z01

The inductive distance sensor BAW Z01... is an accurate distance measurement system for detecting the positions of metallic objects.

- Absolute measuring principle and large measuring range
- Distance-proportional IO-Link output signal
- High repeat accuracy and precision
- Optimal linearity and low temperature drift
- Optimized housing design for clamping distance monitoring

#### Application

In addition to distance detection, thickness and width measurement, part inspection, parts identification and metering tasks, the main application area of the BAW Z01... is linear position monitoring of drive screws for

- Tools
- Workpieces

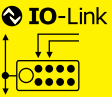

IO-Link  
Product topology  
M8 plastic IO-Link sensor hubs  
M12 metal IO-Link sensor hubs  
M12 plastic IO-Link sensor hubs  
IO-Link sensor/actuator hubs  
M12 metal IO-Link actuator hubs  
**IO-Link sensors**  
IO-Link master  
Accessories

Size	<b>14×38.5×17 mm</b>
Output signal	<b>IO-Link</b>
Installation type	Flush
Linear range $s_i$	1...5 mm
<b>Ordering code</b>	<b>BAW003A</b>
Part number	BAW Z01AC-BLD50B-DP03
Supply voltage $U_B$	18...30 V DC
Residual ripple	≤ 15% of $U_B$
Rated insulation voltage $U_i$	75 V AC
No-load supply current $I_0$ at $U_B$	≤ 12 mA
Polarity reversal protected	Yes
Short-circuit protected	Yes
Ambient temperature $T_a$	-10...+60 °C
Repeat accuracy $R_{BWN}$	±10 μm
Non-linearity	≤ ±150 μm
Response time	5 ms
Degree of protection as per IEC 60529	IP 67
Housing material	Anodized aluminum
Material of sensing face	LCP
Connection	Cable

#### IO-Link

Mode	COM 2
Transfer rate	38.4 kbaud
IO-Link process data length	2 input bytes
Value range	0000 H...03FF H

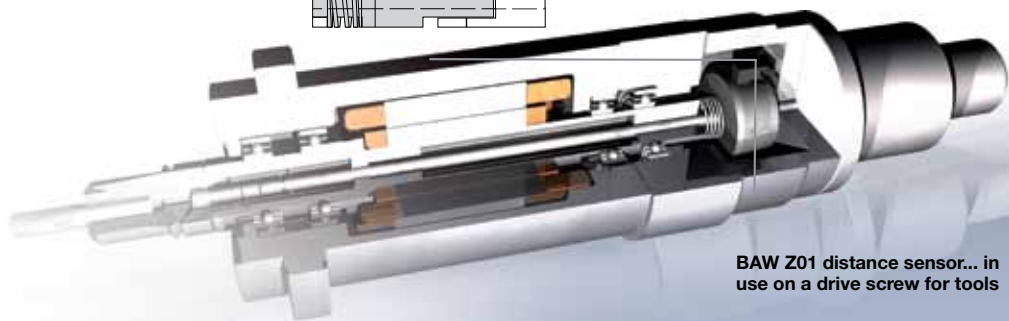
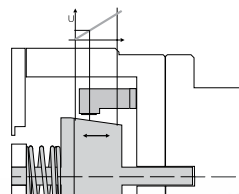
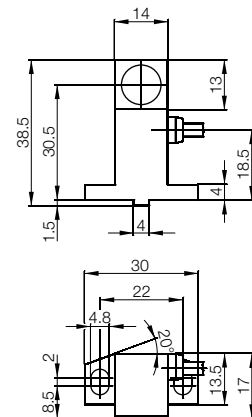

**BAW Z01 distance sensor... in use on a drive screw for tools**

## Industrial RFID system BIS V – The new generation for more efficiency

Typical applications for combining RFID processor units and sensors include identification tasks for material flow control in production systems, for conveyor systems in mechanical engineering, in assembly lines and electric suspension systems or in the entire field of intralogistics.



# IO-Link

## Industrial RFID system BIS V – The new generation for more efficiency



EtherCAT

CC-Link



IO-Link



Description	BIS V RFID processor unit	
Profibus	<b>Ordering code</b>	<b>BIS00T3</b>
	Part number	BIS V-6102-019-C001
EtherCAT	<b>Ordering code</b>	<b>BIS00U9</b>
	Part number	BIS V-6110-063-C002
CC-Link	<b>Ordering code</b>	<b>BIS010P – in preparation</b>
	Part number	BIS V-6111-073-C003
Power supply	24 V DC ±10% LPS Class 2	
Residual ripple	≤ 10%	
Power supply	≤ 2 A	
Ambient temperature T <sub>a</sub>	0...+60 °C	
Degree of protection as per IEC 60529	IP 65	
Housing material	Cast zinc	
Weight	800 g	
Connection H1 - H4	M12 socket, 5-pin, A-coded	
Power connection	7/8" plug, 5-pin	
Application interface	IO-Link 1.1, USB 2.0	
Application with read/write heads	BIS VM-3... and BIS VL-3...	

IO-Link  
Product topology  
M8 plastic sensor hubs  
M12 metal IO-Link sensor hubs  
M12 metal IO-Link sensor hubs  
M12 plastic IO-Link sensor hubs  
IO-Link sensor/actuator hubs  
M12 metal IO-Link actuator hubs  
**IO-Link sensors**  
IO-Link master  
Accessories

CC-Link and EtherNet/IP will be available as additional interfaces in the second half of 2013.

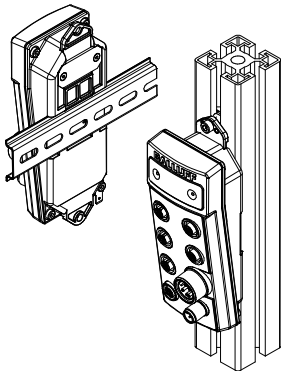
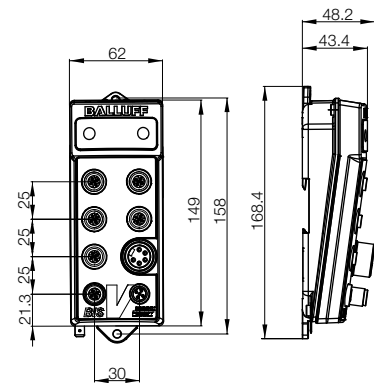

The compact EMC-protected metal housing with small dimensions (170×60×40 mm) is perfectly integrated and simple to mount. In control cabinets or in the field up to IP 65, on a top-hat rail, or on a profile.

The BIS V industrial RFID system was developed and qualified according to the principles of GAMP® 5. Please contact via e-mail for more information: [rfidpharma@balluff.com](mailto:rfidpharma@balluff.com)

The key areas of application for the non-contact

### BIS L-409-045-001-07-S4

identification system are in equipment organization and production, e.g.:

- For controlling material flow
- In workpiece transport on conveyors
- For the detection of safety-relevant data

Information preprogrammed into data carriers can be read and transmitted using non-contact data recognition. This data is transmitted to the IO-Link master via the serial IO-Link port. BIS L-409-045-001-07-S4 is an autonomous unit. No cable-carried power source is required because the energy required is supplied by the integrated read head.



Description/dimensions	<b>40x40x120 mm</b>
Output signal	<b>IO-Link</b>
Housing material	PBT
Antenna type	Round
<b>Ordering code</b>	<b>BIS00CZ</b>
Part number	BIS L-409-045-001-07-S4
Power supply	24 V DC +10%/-20%
Residual ripple	≤ 10%
Power supply	≤ 150 mA
Ambient temperature T <sub>a</sub>	0...+70 °C
Degree of protection as per IEC 60529	IP 67
Mounting in steel	Not flush
LED function indicator	Yes
Connection	M12 connector, 4-pin
Weight	220 g

### IO-Link Version 1.1

Max. cycle time	8.8 ms
IO-Link process data length	8 input bytes/8 output bytes
Communication indicators	Green LED, pulsing

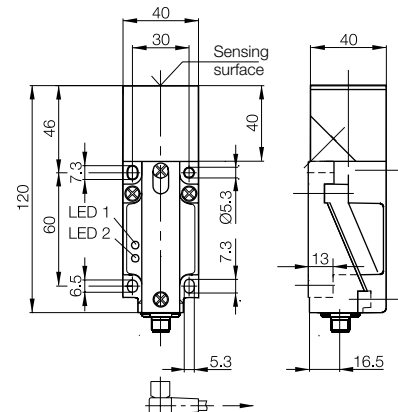

Refer to the Industrial Identification catalog or visit our website for information on data carriers and other identification systems.



■ [www.balluff.com](http://www.balluff.com)

# IO-Link

## Industrial RFID systems BIS L

### Read unit

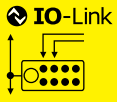

IO-Link  
Product topology  
M8 plastic IO-Link sensor hubs  
M12 metal IO-Link sensor hubs  
M12 plastic IO-Link sensor hubs  
IO-Link sensor/actuator hubs  
IO-Link actuator hubs  
**IO-Link sensors**  
IO-Link master  
Accessories

M12x1 IO-Link	M18x1 IO-Link	25x50x10 mm IO-Link
PBT/nickel-plated brass Round	PBT/nickel-plated brass Round	PBT/ABS Round
<b>BIS00E1</b>	<b>BIS00E0</b>	<b>BIS00E2</b>
BIS L-409-045-003-07-S4	BIS L-409-045-002-07-S4	BIS L-409-045-004-07-S4
24 V DC +10%/-20%	24 V DC +10%/-20%	24 V DC +10%/-20%
≤ 10%	≤ 10%	≤ 10%
≤ 150 mA	≤ 150 mA	≤ 150 mA
0...+70 °C	0...+70 °C	0...+70 °C
IP 67	IP 67	IP 67
Not flush	Not flush	Not flush
Yes	Yes	Yes
M12 connector, 4-pin	M12 connector, 4-pin	M12 connector, 4-pin
170 g	200 g	200 g
8.8 ms	8.8 ms	8.8 ms
8 input bytes/8 output bytes	8 input bytes/8 output bytes	8 input bytes/8 output bytes
Green LED, pulsing	Green LED, pulsing	Green LED, pulsing

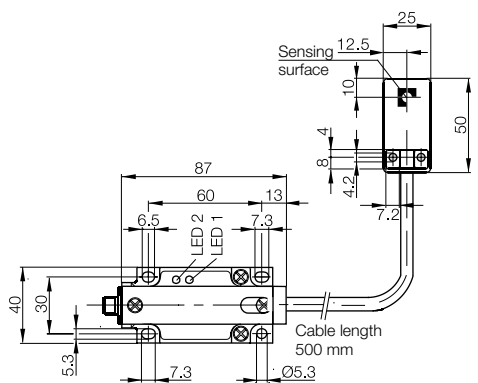
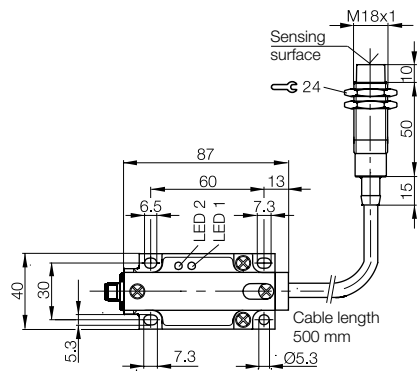
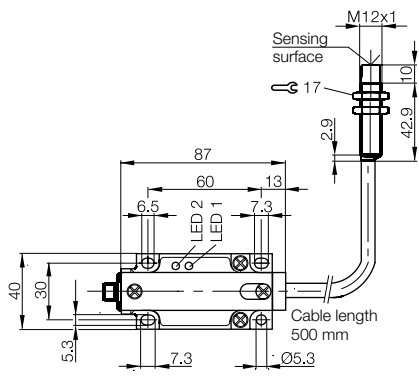

# IO-Link

## Industrial RFID systems BIS M

### Read/write unit



Description/dimensions	<b>M30x1.5</b>	<b>M30x1.5</b>	
Output signal	<b>IO-Link</b>	<b>IO-Link</b>	
Housing material	Nickel-plated CuZn	Nickel-plated CuZn	
Antenna type	Round	Round	
10 bytes	<b>Ordering code</b>	<b>BIS00LH</b>	<b>BIS00LJ</b>
	Part number	BIS M-400-045-001-07-S4	BIS M-400-045-002-07-S4
32 bytes	<b>Ordering code</b>	<b>BIS0102</b>	<b>BIS0103</b>
	Part number	BIS M-401-072-001-07-S4	BIS M-451-072-001-07-S4
Power supply	18...30 V DC	18...30 V DC	
Residual ripple	≤ 1.3 V <sub>pp</sub>	≤ 1.3 V <sub>pp</sub>	
Power supply	≤ 150 mA	≤ 150 mA	
Ambient temperature T <sub>a</sub>	0...+70 °C	0...+70 °C	
Degree of protection as per IEC 60529	IP 67	IP 67	
Mounting in steel	Not flush	Not flush	
LED function indicator	Yes	Yes	
Connection	M12 connector, 4-pin	M12 connector, 4-pin	
Weight	100 g	100 g	

<b>IO-Link</b>			
Communication indicators	Green LED, pulsing	Green LED, pulsing	
<b>10 bytes</b>	Max. cycle time	8.8 ms	8.8 ms
	IO-Link process data length	10 input bytes/10 output bytes	10 input bytes/10 output bytes
<b>32 bytes</b>	Max. cycle time	24 ms	24 ms
	IO-Link process data length	32 input bytes/32 output bytes	32 input bytes/32 output bytes

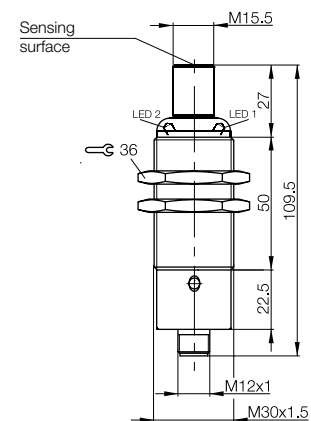
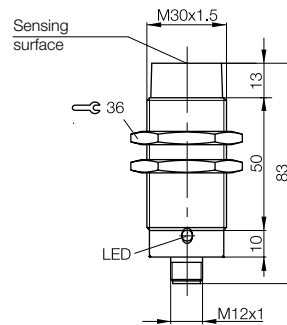

Refer to the Industrial Identification catalog or visit our website for information on data carriers and other identification systems.



www.balluff.com



# IO-Link

## Industrial RFID systems BIS M

### Read/write unit

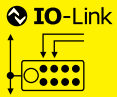

IO-Link  
Product topology  
M8 plastic sensor hubs  
M12 metal IO-Link sensor hubs  
M12 plastic IO-Link sensor hubs  
IO-Link sensor/actuator hubs  
M12 metal IO-Link actuator hubs  
**IO-Link sensors**  
IO-Link master  
Accessories

<b>M18x1</b>	<b>25x50x10 mm</b>
<b>IO-Link</b>	<b>IO-Link</b>
AlMgSi <sub>0.5</sub> /nickel-plated brass	AlMgSi 0.5/ABS-GF16
Round	Round
<b>BIS00LW</b>	<b>BIS00M1</b>
BIS M-402-045-002-07-S4	BIS M-402-045-004-07-S4
<b>BIS0106</b>	<b>BIS0108</b>
BIS M-402-072-004-07-S4	BIS M-400-072-001-07-S4
18...30 V DC	18...30 V DC
≤ 1.3 V <sub>pp</sub>	≤ 1.3 V <sub>pp</sub>
≤ 150 mA	≤ 150 mA
0...+70 °C	0...+70 °C
IP 67	IP 67
Not flush	Not flush
Yes	Yes
M12 connector, 4-pin	M12 connector, 4-pin
220 g	220 g

Green LED, pulsing	Green LED, pulsing
8.8 ms	8.8 ms
10 input bytes/10 output bytes	10 input bytes/10 output bytes
24 ms	24 ms
32 input bytes/32 output bytes	32 input bytes/32 output bytes

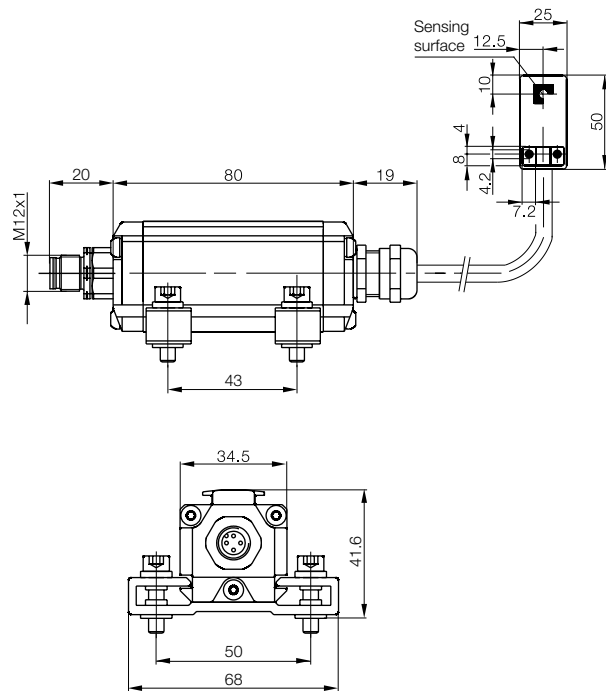
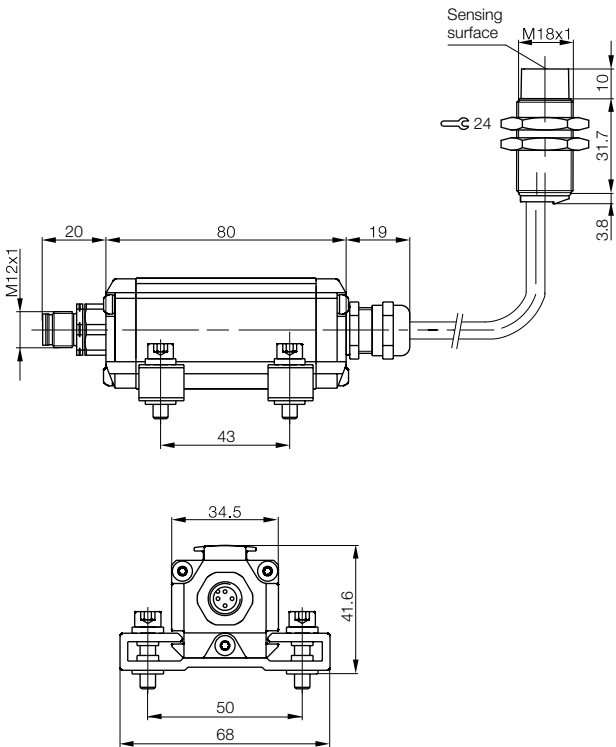

# IO-Link

## Industrial RFID systems BIS M

### Read/write unit



Description/dimensions	<b>80x80x40 mm</b>	<b>80x80x40 mm</b>
Output signal	<b>IO-Link</b>	<b>IO-Link</b>
Housing material	PBT	PBT
Antenna type	Round	Rod
10 bytes	<b>Ordering code</b> <b>BIS00LK</b>	<b>BIS00LM</b>
	Part number	BIS M-401-045-001-07-S4
32 bytes	<b>Ordering code</b> <b>BIS0104</b>	<b>BIS0105</b>
	Part number	BIS M-400-072-002-07-S4
Power supply	18...30 V DC	18...30 V DC
Residual ripple	≤ 1.3 Vpp	≤ 1.3 Vpp
Power supply	≤ 150 mA	≤ 150 mA
Ambient temperature T <sub>a</sub>	0...+70 °C	0...+70 °C
Degree of protection as per IEC 60529	IP 67	IP 67
Mounting in steel	Not flush	Not flush
LED function indicator	Yes	Yes
Connection	M12 connector, 4-pin	M12 connector, 4-pin
Weight	190 g	360 g

#### IO-Link

Communication indicators	Green LED, pulsing	Green LED, pulsing
<b>10 bytes</b>	Max. cycle time	8.8 ms
	IO-Link process data length	10 input bytes/10 output bytes
<b>32 bytes</b>	Max. cycle time	24 ms
	IO-Link process data length	32 input bytes/32 output bytes

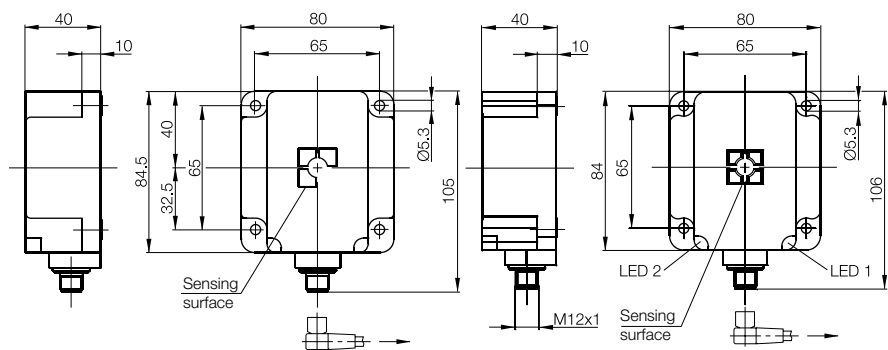

Refer to the Industrial Identification catalog or visit our website for information on data carriers and other identification systems.



www.balluff.com

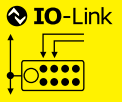

IO-Link  
Product  
topology  
M8 plastic  
IO-Link  
sensor hubs  
M12 metal  
IO-Link  
sensor hubs  
M12 plastic  
IO-Link  
sensor hubs  
IO-Link sensor/  
actuator hubs  
M12 metal  
IO-Link  
actuator hubs  
**IO-Link  
sensors**  
IO-Link  
master  
Accessories



# Mechanical multiple position switches BNS Series 100

## Multiple position switches in accordance with DIN 43697 with safety switch positions as per DIN EN 60204-1/VDE 0113

- Positive-opening contacts and rigid plunger for additional security as per DIN EN 60204-1/VDE 0113

- Dual-chamber system with IP 67 degree of protection: wear-free membrane with hermetic sealing of plunger mechanism and switch chamber
- Maintenance-free, self-lubricating plunger guide with slide bearing

## Multiple position switches with function indicator

- Function indicators for choice of three voltage ranges

## Multiple position switches with wiper plate

- Increased function security under extreme conditions of use
- Wiper plate prevents plunger from sticking in the guide
- For use in wet areas with strongly adhering media



### IO-Link

- Simple installation: with M12 connector
- No cable gland needed, factory sealed to IP 67
- Connect in just seconds
- High diagnostic capability through parallel processing of normally open/normally closed signals

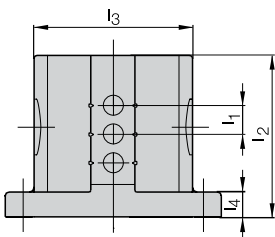

### Available sizes

Number of plungers		2	3	4	5	6	8	10	12
Dimension l <sub>2</sub> with	Dimension l <sub>1</sub> = 12 mm	70	80	90	105	120	140	170	200
	Dimension l <sub>3</sub>	88	88	88	88	88	80	80	80
	Dimension l <sub>4</sub>	14	14	14	14	14	20	20	20
	Dimension l <sub>1</sub> = 16 mm	70	90	105	120	140	170	200	240
	Dimension l <sub>3</sub>	88	88	88	88	80	80	80	80
	Dimension l <sub>4</sub>	14	14	14	14	20	20	20	20

Dimensions in mm

Ordering example:

**BNS 819-D02-D16-100-10-FD-S4R-I**

**BNS 819-D - - -100-10-FD- - -I**

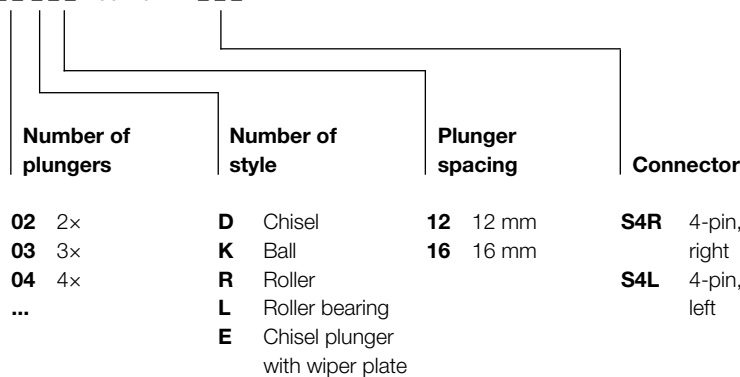

- Optimized for your application
- Customer-specific solutions are available
- Contact us.

# IO-Link

## Mechanical multiple position switches BNS Series 100

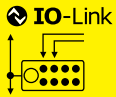

IO-Link  
Product topology  
M8 plastic IO-Link sensor hubs  
M12 metal IO-Link sensor hubs  
M12 plastic IO-Link sensor hubs  
IO-Link sensor/actuator hubs  
M12 metal IO-Link actuator hubs  
**IO-Link sensors**  
IO-Link master  
Accessories

Type	<b>Series 100 multiple position switch</b>
Output signal	<b>IO-Link</b>
Plunger spacing	12 mm or 16 mm
Mounting and function dimensions	as per DIN 43697
Plunger style	Chisel ( <b>D</b> ), ball ( <b>K</b> ), roller ( <b>R</b> ), roller bearing ( <b>L</b> ) or chisel plunger with wiper plate ( <b>E</b> )
Plunger material	Stainless steel, contact surfaces induction-hardened
Housing material	Cast aluminum, corrosion-resistant, anodized finish
Connection	M12 connector
Ambient temperature range	-5...+85 °C
Degree of protection as per IEC 60529	IP 67
With switch element	<b>BSE 30.0</b>
<b>Ordering code</b>	
Part number	BNS 819-...-...-100-10-FD-S4...
Wiring diagram, style	

<b>Switch element</b>	
Contact material	Silver, gold plated
Switching principle	Snap switch
Contact system	Dual changeover, one normally open and one normally closed, galvanically isolated.
Electrical data	See catalog "The Mechanical Line"

<b>Mechanical data</b>	
Plunger point to reference surface	8 mm
Switching point to reference surface	6 mm
Maximum plunger travel D, K, R, L	5.5 mm
Maximum plunger travel E	4 mm
Switching actuating force on plunger	Min. 20 N
Switching rate	max. 300/min
Startup speed	Plunger D 40 m/min Plunger E 30 m/min Plunger K 8 m/min Plunger R 20 m/min Plunger L 120 m/min
Repeatability	Plungers D, E, K ±0.002 mm Plungers R, L ±0.01 mm

<b>IO-Link</b>	
Mode	COM 2
Transfer rate	38.4 kbaud
IO-Link process data length	2 input bytes
Parameter	NC/NO

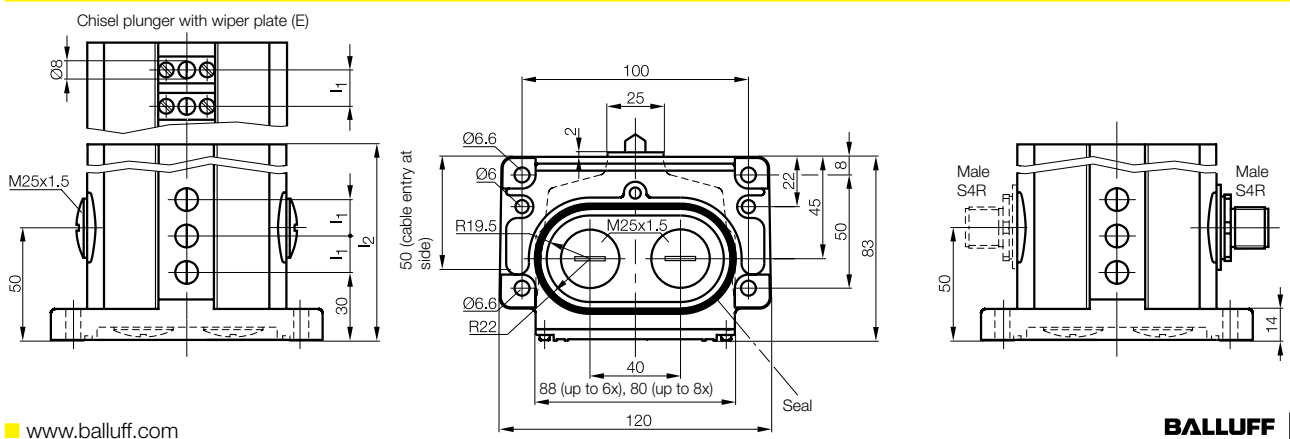

**Mechanical multiple position switches BNS Series 46**

**Multiple position switches for standard applications**

- Smallest plunger spacing for mechanical multiple position switches (8 mm or 10 mm)
- Dual-chamber system with IP 67 degree of protection: wear-free membrane with hermetic sealing of plunger mechanism and switch chamber
- Maintenance-free, self-lubricating plunger guide with slide bearing

**Multiple position switches with wiper plate**

- Increased function security under extreme conditions of use
- Wiper plate prevents plunger from sticking in the guide
- For use in wet areas with strongly adhering media

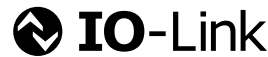

**IO-Link**

- Simple installation: with M12 connector
- No cable gland needed, factory sealed to IP 67
- Connect in just seconds
- High diagnostic capability through parallel processing of normally open/normally closed signals

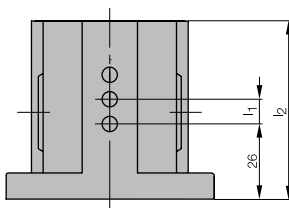

**Available sizes**

Number of plungers		2	3	4	5	6	8	10
Dimension l <sub>2</sub> with	Dimension l <sub>1</sub> = 8 mm	49	59	64	72	80	96	112
	Dimension l <sub>3</sub>	54	54	54	54	54	50	50
	Dimension l <sub>1</sub> = 10 mm	49	59	72	80	89	112	129
	Dimension l <sub>3</sub>	54	54	54	54	50	50	50

Dimensions in mm

Ordering example:

**BNS 819-B04-D08-46-12-FD-S4R-I**

**BNS 819-B - - - -46-12-FD- - - -I**

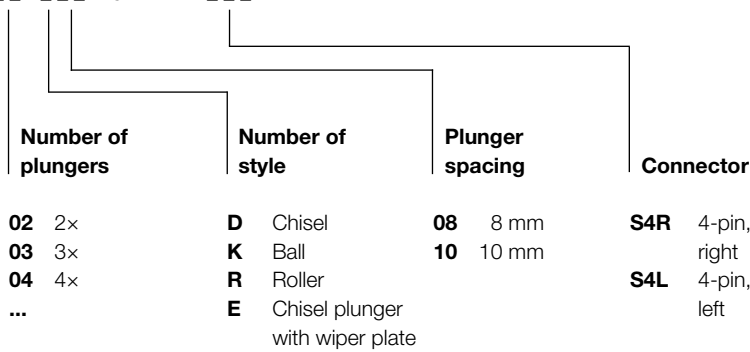

# IO-Link

## Mechanical multiple position switches BNS Series 46

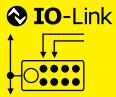

IO-Link  
 Product topology  
 M8 plastic IO-Link sensor hubs  
 M12 metal IO-Link sensor hubs  
 M12 plastic IO-Link sensor hubs  
 IO-Link sensor/actuator hubs  
 M12 metal IO-Link actuator hubs  
**IO-Link sensors**  
 IO-Link master  
 Accessories

Type	<b>Series 46 multiple position switch</b>
Output signal	<b>IO-Link</b>
Plunger spacing	8 mm or 10 mm
Plunger style	Chisel ( <b>D</b> ), ball ( <b>K</b> ), roller ( <b>R</b> ), roller bearing ( <b>L</b> ) or chisel plunger with wiper plate ( <b>E</b> )
Plunger material	Stainless steel, contact surfaces induction-hardened
Housing material	Cast aluminum, corrosion-resistant, anodized finish
Connection	M12 connector
Ambient temperature range	-5...+85 °C
Degree of protection as per IEC 60529	IP 67
With switch element	<b>BSE 73</b>
<b>Ordering code</b>	
Part number	BNS 819-B.-...-46-12-FD-S4...
Wiring diagram, style	

<b>Switch element</b>	
Contact material	Gold
Switching principle	Snap switch
Contact system	Single-pin changeover
Connection	Solder connection
Electrical data	See catalog "The Mechanical Line"

<b>Mechanical data</b>	
Plunger point to reference surface	4 mm
Switching point to reference surface	3.5 mm
Maximum plunger travel	3.5 mm
Switching actuating force on plunger	Min. 8 N
Switching rate	Max. 200/min
Startup speed	Plungers D, E: 20 m/min (D), 10 m/min (E) Plunger K: 9 m/min Plunger R: 60 m/min
Repeatability	Plungers D, E: ±0.02 mm Plunger K: ±0.03 mm Plunger R: ±0.05 mm

<b>IO-Link</b>	
Mode	COM 2
Transfer rate	38.4 kbaud
IO-Link process data length	2 input bytes
Parameter	NC/NO

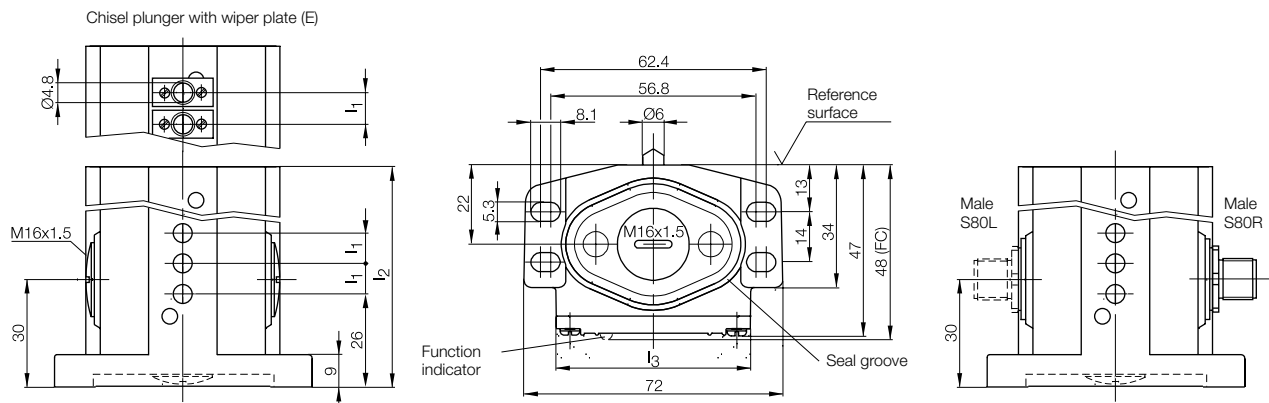

- High power density saves installation space
- Adjustable measurement range for rapid commissioning
- Large distance between encoder and measurement system for easy installation

The structural design, high degree of protection and simple installation of Balluff Micropulse transducers in a profiled housing makes them an excellent alternative to linear transducers, such as potentiometers, glass rulers and LVDTs. The measurement section is protected inside an extruded aluminum profile.

A passive encoder with no power supply marks the measuring point on the measuring path without making contact. Measuring ranges between 50 and 4500 mm are possible.



For information on our micropulse transducers BTL and BIW, refer to our new catalog or visit our website at [www.balluff.com](http://www.balluff.com)



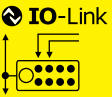

IO-Link  
Product topology  
M8 plastic IO-Link sensor hubs  
M12 metal IO-Link sensor hubs  
M12 plastic IO-Link sensor hubs  
IO-Link sensor/actuator hubs  
M12 metal IO-Link actuator hubs  
**IO-Link sensors**  
IO-Link master  
Accessories

- Non-contact measurement of the measurement position
- IP 67, insensitive to contamination
- Wear-free
- Insensitive to shock and vibration
- Absolute output signal
- Max. resolution of 0.001 mm (depending on the processing electronics)
- Adjustable measuring range
- Diagnostic LED
- Free-moving and guided encoders
- Maximum distance of 15 mm between the position measuring system and the floating position encoder

Series	BTL6-PF
Shock load	50 g/6 ms as per IEC 60068-2-27
Vibration	12 g, 10...2000 Hz as per IEC 60068-2-6
Polarity reversal protected	Yes (up to 36 V)
Overvoltage protection	to 36 V
Dielectric strength	500 V (GND to housing)
Degree of protection as per IEC 60529	IP 67 (with IP 67 connector BKS-S... attached)
Housing material	Anodized aluminum
Housing attachment	Compression clamps
Connection	Connector
<b>EMC testing</b>	
Radio interference emission	EN 55016-2-3 Group 1, Class A and B
Static electricity (ESD)	EN 61000-4-2 Severity level 3
Electromagnetic fields (RFI)	EN 61000-4-3 Severity level 3
Electrical fast transient bursts	EN 61000-4-4 Severity level 3
Surge voltage	EN 61000-4-5 Severity level 2
Conducted interference induced by high-frequency fields	EN 61000-4-6 Severity level 3
Magnetic fields	EN 61000-4-8 Severity level 4
Standard nominal strokes [mm]	0050, 0100, 0130, 0150, 0175, 0200, 0225, 0250, 0300, 0350, 0360, 0400, 0450, 0500, 0550, 0600, 0650, 0700, 0750, 0800, 0850, 0900, 0950, 1000, 1100, 1200, 1250, 1300, 1400, 1500, 1600, 1700, 1750, 1800, 1900, 2000, 2250, 2500, 2750, 3000, 3250, 3500, 3550, 3750, 4000, 4250, 4500

#### Free-moving and guided encoders

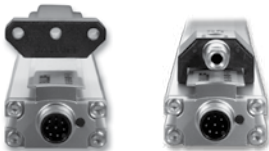

Maximum distance of **15 mm** between the distance measurement system and the free-moving encoder.

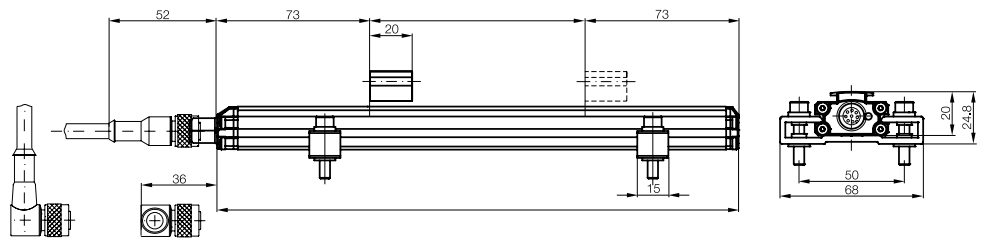



#### Contactless position measurement technology with IO-Link

Micropulse PF IO-Link is an absolute and non-contact position measuring system that continuously provides measurements in  $\mu\text{m}$  on a 1 ms cycle. These measurements are directly and digitally transmitted via IO-Link.

IO-Link is a point-to-point connection within any network. An IO-Link system consists of an IO-Link device such as a sensor or actuator, an IO-Link master and the wiring. Master modules are available with all current fieldbus protocols. The Micropulse PF IO-Link device is coupled to the master via a maximum 20 m long standard sensor/actuator line. Micropulse PF IO-Link operates using COM3 communication speed (230 kB), which achieves a process data cycle of 1 ms with a 1.1 master. Via IO-Link, the user interface can be mapped based on an IODD (IO Device Description) in the engineering system. Due to the continuous flow of information, all data is centrally and permanently saved, so that configuration is possible and reproducible at any time.

#### Your added value with the PF IO-Link profile

- Simple to configure, quick to install and bring into operation
- COM 3, 1 ms process data cycle possible, securely measure quick movements
- OTF, automatic configuration in running operation (on the fly)
- Continuous monitoring and diagnostics
- High transfer rate, quick process data cycle
- Cost-effective to wire with standard M12 cable connector
- Easy to integrate in the controller via standard IO-Link modules
- For harsh, industrial environments, use with Balluff IO-Link master component groups in IP 67

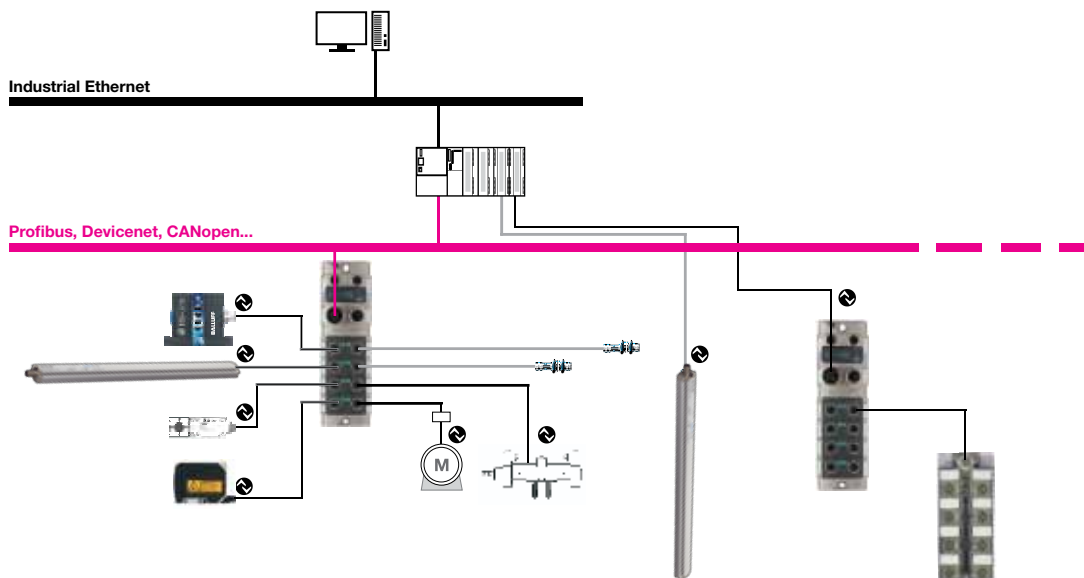

**Micropulse position measurer BTL6, profile PF IO-Link**  
**Simple to configure, time-saving to install and bring into operation**

Micropulse position measuring systems enclosed in a PF profiled housing are non-contact, absolute measuring systems used for accurately measuring measurement paths. They are characterized by their very flat design and the robust structure with high IP 67 degree of protection. The current axis positions are "marked" by the position encoder magnets through the wall of the aluminum profile. These position measuring systems tolerate a lateral offset as well as a height offset of up to 15 mm.

**Advantages and characteristics of the PF profile**

- Very flat design for simple pass over
- Non-contact measurement of the measurement position
- IP 67, insensitive to contamination
- Insensitive to shock and vibration
- Absolute output signal
- Measurement length up to 4570 mm
- 1 µm resolution
- ±200 µm linearity deviation
- Error and status LED

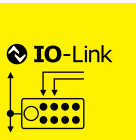

- IO-Link
- Product topology
- M8 plastic IO-Link sensor hubs
- M12 metal IO-Link sensor hubs
- M12 plastic IO-Link sensor hubs
- IO-Link sensor/actuator hubs
- M12 metal IO-Link actuator hubs
- IO-Link sensors**
- IO-Link master
- Accessories



**Ordering example:**

**BTL6-U110-M \_ \_ \_ -PF-S4**

IO-Link V1.1

Rated length [mm]

50...4570 mm in 5 mm increments

**BTL6 profile PF measurement detector with free and guided position encoder and plug connection S4**

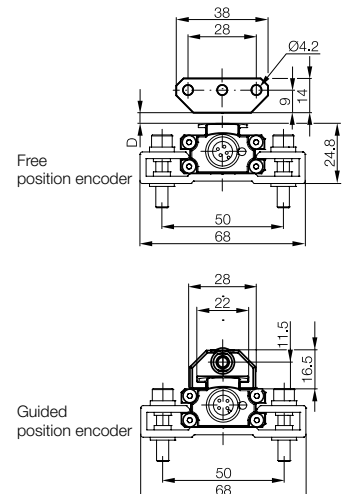
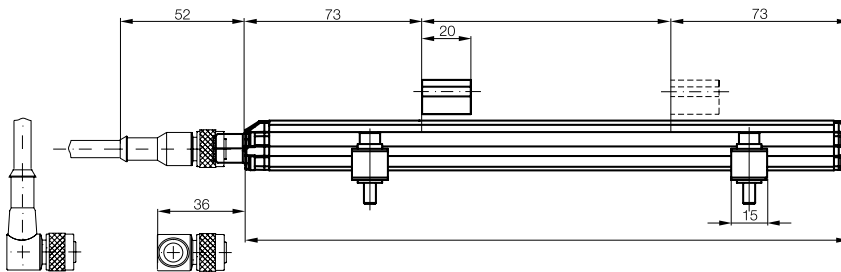

### New options in installation, diagnostics and activation

The BNI IOL-770-V06-A027 module connects process-related, installed valve clusters in the simplest way with the control level. As common with IO-Link, it is ready to connect and has a simple, 3-wire standard cable. Eliminates complicated parallel wiring and risk of mixing up cables. Because the "intelligence" is in the interface, nothing changes in the valve cluster or its individual valves.

The valve cluster activation combines 24 double valves with the control level. The module is connected to the VQC valve cluster types from SMC via the preinstalled, 26-pin round plug. This saves enormous wiring effort and reduces sources of error very substantially. A common 3-wire standard cable is docked on the other end of the screw-in M12 plug and assumes the complete electric control and the transport of all process and service data to and from the valve cluster.

The omission of high-effort, multiple wiring enables lean wiring concepts and saves space, time and money. The excellent diagnostics functions, such as short-circuit and coil break monitoring, provide for increased security in system operation.



Connector diagram and wiring IO-Link interface, M12, A-coded, pin	 <p>PIN 1: +24 V, supply voltage PIN 2: +24 V, supply voltage Power Aux Pin 3: GND, reference potential PIN 4: Q/C, IO-Link data transmission channel PIN 5: -</p>
Version	Power Aux valve terminal connector
Supply voltage $U_B$	18...30.2 V DC
Outputs	24
IO-Link process data length	4 input bytes/4 output bytes
Error indicator	Red LED
Communication indicator	Green LED
Transmission protocol	IO-Link Version 1.1
Transfer rate	COM 2/38.4 kBaud
Interface area	M27 socket, 26 pin
IO-Link process data length	9 byte input/4 byte output
Cycle time min.	5.5 ms IO-Link version 1.1
Operating temperature $T_a$	-5...+70 °C
Storage temperature	-25...+70 °C
Dimensions	187×32×32 mm without cable
Housing material	Aluminum
Total current $I_S$	1.2 A
Degree of protection	IP 65
Cable length with M27 socket	50 cm

Cable material	Color	Length	Ordering code
			Part number
PVC	Gray	0.5 m	<b>BNI004W</b> BNI IOL-770-V06-A027

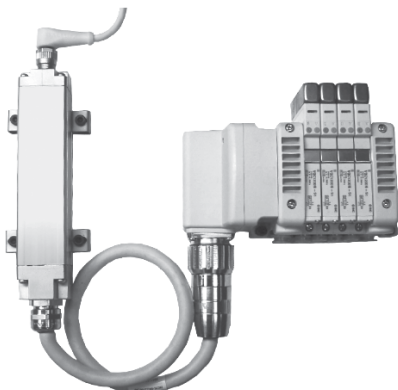
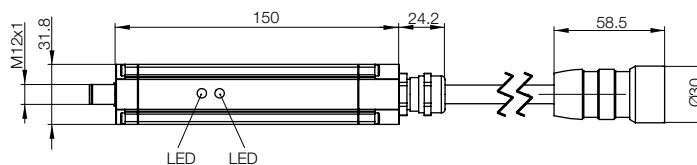

- Compact adapter housing for docking directly on the valve cluster
- Switchable via IO-Link to different fieldbuses, cross-manufacturer openness
- Connection to control level is made with common 3-wire sensor cables, saving wiring effort
- Excellent diagnostics functions such as short-circuit, coil break, power supply

Signal assignment M27 socket round plug in accordance with SMC-VQC valve clusters

# IO-Link

## Universal IO-Link interface

### Universal IO-Link interface – unlimited options

Via the BNI IOL-771-000-K027 module, all devices are open for IO-Link with up to 16 inputs/outputs.

In a process-related manner, pumps, signal lights, control panels, valve clusters, switch units, transfer units, and much more are connected with the control level in the simplest way. The module provides both the fast IO-Link connection via the standard sensor line and an open cable with 10 or 18 wires, depending on the exact version.

With it, now any electric unit with up to 16 inputs/outputs can be connected to the control system via a standard sensor cable.

The omission of high-effort, multiple wiring enables lean wiring concepts and saves space, time and money.

#### The benefits to you

- Compact adapter housing for direct connection to different devices
- Via IO-Link, universal and fieldbus-independent
- Connection to control level with common sensor cable, reduces wiring effort
- Variants available with 8 or 16 input/output signals



Connector diagram and wiring IO-Link interface, M12, A-coded, pin	 <p>PIN 1: +24 V, supply voltage PIN 2: +24 V, supply voltage Power Aux PIN 3: GND, reference potential PIN 4: Q/C, IO-Link data transmission channel Pin 5: Function ground</p>
Version	IO-Link interface
Supply voltage $U_B$	18...30.2 V DC
IO-Link process data length	2 input bytes/2 output bytes
Indicators and monitoring	Power supply, communication, diagnostics
Transmission protocol	IO-Link version 1.1
Transfer rate	COM 2 (38.4 kBaud)
Cycle time min.	4 ms
Operating temperature $T_a$	-5...+75 °C
Storage temperature	-25...+85 °C
Dimensions	83.3x43.3x15 mm without cable
Housing material	Plastic
Total current $U_O$	1.2 A
Degree of protection	IP 54

Cable material	Color	Length	Ordering code
			Part number
PVC	Gray	0.4 m	<b>BNI005M</b>
			BNI IOL-771-000-K027

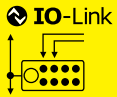

IO-Link  
Product topology  
M8 plastic IO-Link sensor hubs  
M12 metal IO-Link sensor hubs  
M12 plastic IO-Link sensor hubs  
IO-Link sensor/actuator hubs  
M12 metal IO-Link actuator hubs  
**IO-Link sensors**  
IO-Link master  
Accessories

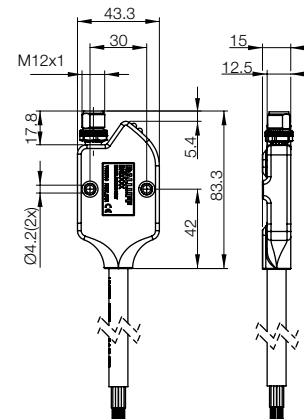



# IO-Link

## Valve terminal connectors

Festo CPV,  
Bosch Rexroth LS04, HF04



SMC VQC

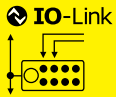

IO-Link  
Product topology  
M8 plastic IO-Link sensor hubs  
M12 metal IO-Link sensor hubs  
M12 plastic IO-Link sensor hubs  
M12 metal IO-Link actuator hubs  
IO-Link sensor/actuator hubs  
IO-Link master  
Accessories

Valve terminal connectors	Power Aux valve terminal connector	Valve terminal connectors	Power Aux valve terminal connector
<b>IO-Link</b>	<b>IO-Link</b>	<b>IO-Link</b>	<b>IO-Link</b>
SUB-D 25-pin	SUB-D 25-pin	SUB-D 25-pin	SUB-D 25-pin
<b>BNI001E</b>	<b>BNI001L</b>	<b>BNI001J</b>	<b>BNI001N</b>
BNI IOL-750-V02-K007	BNI IOL-751-V02-K007	BNI IOL-750-V04-K007	BNI IOL-751-V04-K007
16	16	16	16
2 bytes	2 bytes	2 bytes	2 bytes
3 ms	3 ms	3 ms	3 ms
<b>BNI001F</b>	<b>BNI001K</b>	<b>BNI001H</b>	<b>BNI001M</b>
BNI IOL-750-V01-K007	BNI IOL-751-V01-K007	BNI IOL-750-V03-K007	BNI IOL-751-V03-K007
24	24	24	24
3 bytes	3 bytes	3 bytes	3 bytes
12 ms	12 ms	12 ms	12 ms
16	16	24	24
2 bytes	2 bytes	3 bytes	3 bytes
2.5 ms	2.5 ms	10 ms	10 ms
-5...+55 °C	-5...+55 °C	-5...+55 °C	-5...+55 °C
-25...+70 °C	-25...+70 °C	-25...+70 °C	-25...+70 °C
Plastic	Plastic	Plastic	Plastic
53×60.8×12.5 mm	53×60.8×12.5 mm	53×60.8×12.5 mm	53×60.8×12.5 mm
60 cm	60 cm	60 cm	60 cm
IP 40	IP 40	IP 40	IP 40
Red LED	Red LED	Red LED	Red LED
Green LED	Green LED	Green LED	Green LED
18...30.2 V DC	18...30.2 V DC	18...30.2 V DC	18...30.2 V DC
1.6 A	1.6 A	1.6 A	1.6 A
Pin 1: +24 V supply voltage	Pin 1: Controller +24 V supply voltage	Pin 1: +24 V supply voltage	Pin 1: Controller +24 V supply voltage
Pin 2: -	Pin 2: Operating voltage +24 V power aux	Pin 2: -	Pin 2: Operating voltage +24 V power aux
Pin 3: GND, reference potential	Pin 3: GND, reference potential	Pin 3: GND, reference potential	Pin 3: GND, reference potential
Pin 4: Q/C, IO-Link	Pin 4: Q/C, IO-Link	Pin 4: Q/C, IO-Link	Pin 4: Q/C, IO-Link
Pin 5: Function ground	Pin 5: Function ground	Pin 5: Function ground	Pin 5: Function ground
COM 2	COM 2	COM 2	COM 2
38.4 kbaud	38.4 kbaud	38.4 kbaud	38.4 kbaud

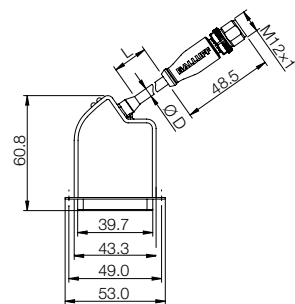
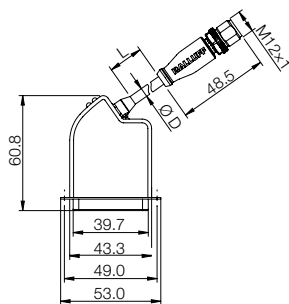
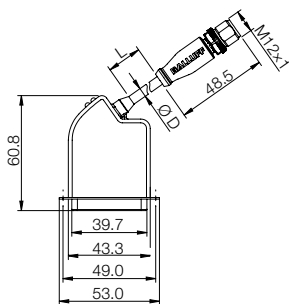
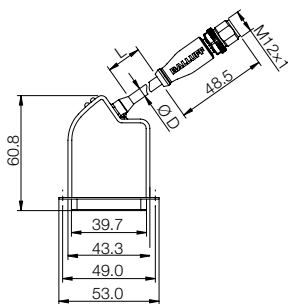

# IO-Link

## Analog adapter

### Converting analog signals into IO-Link signals and saving costs in the process

The number of analog data/information/signals is generally less than 10% of the signals generated in most systems and machines.

The connection and integration of analog input/output signals is associated with high costs due to the use of shielded cables on the installation side and expensive multi-channel input modules on the control side.

Our IO-Link analog plugs provide the fix. They provide considerable cost reduction potential for systems with limited analog value formation.

Expensive shielded cables are replaced with simple unshielded three-core cables. The signal neutrality of the IO-Link ports on the IO-Link master modules, together with the IO-Link analog plugs, ensures maximum signal variance. This makes "mixing" different input/output/current and voltage signals in one module possible.

#### Features

- Compact housing
- High, 14-bit resolution
- Extended temperature range
- Inputs and outputs



IO-Link Version	Device	
	1 AI, 0...10 V DC	
<b>Ordering code</b>	<b>BNI0042</b>	
Part number	BNI IOL-714-000-K023	
Supply voltage $U_B$	18...30 V DC	
Connection: IO-Link	M12, A-coded, male	
Analog interface connection	M12, A-coded, female	
Number of analog ports	1	
Interface	0...10 V DC input	
Resolution	14 Bit	
Max. load current, sensors/channel	1 A	
Max. load current actuators/channel	1.4 A	
Degree of protection as per IEC 60529	IP 67 (when screwed into place)	
Operating temperature $T_a$	-5...+70 °C	
Storage temperature	-25...+70 °C	
Weight	21 g	
Dimensions (L×W×H)	40×12×50 mm	
Housing material	Plastic	

#### IO-Link

Max. cycle time	3 ms	
IO-Link process data length	2 input bytes	
Indicators	Communication	Green LED, pulsing
	Module OK	Green LED

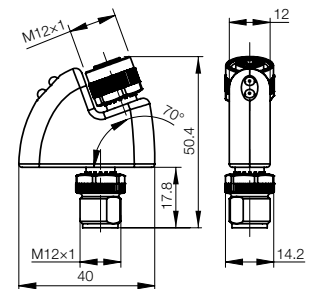



# IO-Link Analog adapter

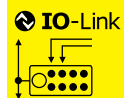

IO-Link  
Product  
topology  
M8 plastic  
sensor hubs  
M12 metal  
IO-Link  
sensor hubs  
M12 plastic  
IO-Link  
sensor hubs  
IO-Link sensor/  
actuator hubs  
M12 metal  
IO-Link  
actuator hubs  
**IO-Link  
sensors**  
IO-Link  
master  
Accessories



Device	Device	Device	Device
1 AI, 4...20 mA	1 AI, PT100	1 AO, 4...20 mA	1 AO, 0...10 V DC
<b>BNI004I</b>	<b>BNI004T</b>	<b>BNI004C</b>	<b>BNI004E</b>
BNI IOL-712-000-K023	BNI IOL-716-000-K023	BNI IOL-722-000-K023	BNI IOL-724-000-K023
18...30 V DC	18...30 V DC	18...30 V DC	18...30 V DC
M12, A-coded, male	M12, A-coded, male	M12, A-coded, male	M12, A-coded, male
M12, A-coded, female	M12, A-coded, female	M12, A-coded, female	M12, A-coded, female
1	1	1	1
4...20 mA input	PT 100 Input	4...20 mA output	0...10 V DC output
14 Bit	14 Bit	14 Bit	14 Bit
1 A	1 A	1 A	1 A
1.4 A	1.4 A	1.4 A	1.4 A
IP 67 (when screwed into place)	IP 67 (when screwed into place)	IP 67 (when screwed into place)	IP 67 (when screwed into place)
-5...+70 °C	-5...+70 °C	-5...+70 °C	-5...+70 °C
-25...+70 °C	-25...+70 °C	-25...+70 °C	-25...+70 °C
21 g	21 g	21 g	21 g
40×12×50 mm	40×12×50 mm	40×12×50 mm	40×12×50 mm
Plastic	Plastic	Plastic	Plastic

3 ms	3 ms	3 ms	3 ms
2 input bytes	2 input bytes	2 output bytes	2 output bytes
Green LED, pulsing	Green LED, pulsing	Green LED, pulsing	Green LED, pulsing
Green LED	Green LED	Green LED	Green LED

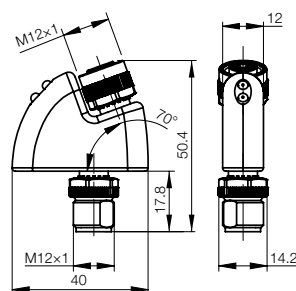
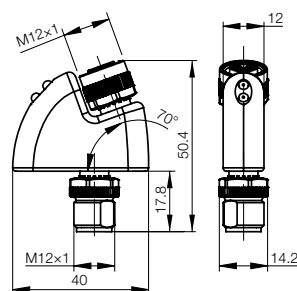
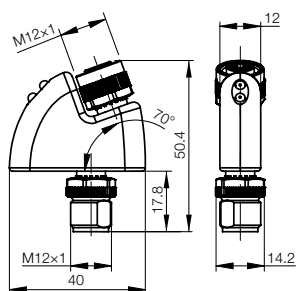
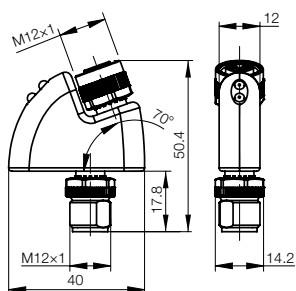

With a housing length of only 41 mm, the new ultrasonic sensors BUS 18M are extremely compact. With their narrow sound cone and a blind zone of only 20 mm, they provide flexible application options. Two housing variants—straight and with a 90° angle head—are available, each with four scanning ranges up to 1.3 m. The sensor family covers a broad range of applications—through three different output stages: a push-pull switching output or an analog output, available with 4...20 mA or 0...10 V. The highlight is the complete support of the IO-Link interface. Via the switching output, the sensors can communicate with an IO-Link-capable controller or an IO-Link master.

The sensors can be synchronized with one another, so that they do not influence one another.

**Features**

- 2 housing variants
- Measuring range from 20 mm to 1.3 m
- Push-pull switching output
- Analog output 4...20 mA or 0...10 V
- Teach-in via control line
- Temperature compensation

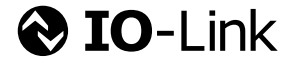

**Operating scanning range**

**BUS M18M switching output, straight**

Resolution		
push/pull	NO/NC	<b>Ordering code</b>
	IO-Link	Part number

**BUS W18M switching output, right-angle**

Resolution		
push/pull	NO/NC	<b>Ordering code</b>
	IO-Link	Part number

Size	
Supply voltage	
Output current	
Degree of protection as per EN 60529	
Operating temperature	
Material	Housing
	Plastic parts
	Sensing surface
Connection	

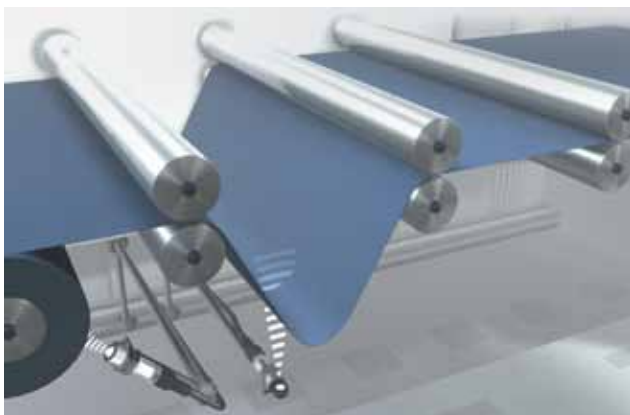

**Control foil sag and monitor roll diameter**

Using an ultrasonic sensor with analog output, the material on a roll is detected and the roll drive or a brake readjusted. Another sensor with analog output readjusts the material infeed at the dancer roller as a function of the cable loop.

# IO-Link

## Ultrasonic sensors BUS \_18M

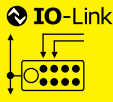

IO-Link  
Product topology  
M8 plastic IO-Link sensor hubs  
M12 metal IO-Link sensor hubs  
M12 plastic IO-Link sensor hubs  
IO-Link sensor/actuator hubs  
M12 metal IO-Link actuator hubs  
**IO-Link sensors**  
IO-Link master  
Accessories

	20...150 mm	30...250 mm	65...350 mm	120...1000 mm
	0.069 mm	0.069 mm	0.069 mm	0.069 mm
	<b>BUS0020</b>	<b>BUS0029</b>	<b>BUS004Z</b>	<b>BUS004P</b>
	BUS M18M1-GPXI-02/015-S92G	BUS M18M1-GPXI-03/025-S92G	BUS M18M1-GPXI-07/035-S92G	BUS M18M1-GPXI-12/100-S92G
	0.069 mm	0.069 mm	0.069 mm	0.069 mm
	<b>BUS0023</b>	<b>BUS002A</b>	<b>BUS004Y</b>	<b>BUS004N</b>
	BUS W18M1-GPXI-02/015-S92G	BUS W18M1-GPXI-03/025-S92G	BUS W18M1-GPXI-07/035-S92G	BUS W18M1-GPXI-12/100-S92G
	M18x1	M18x1	M18x1	M18x1
	10...30 V DC	10...30 V DC	10...30 V DC	10...30 V DC
	100 mA	100 mA	100 mA	100 mA
	IP 67	IP 67	IP 67	IP 67
	-25...+70 °C	-25...+70 °C	-25...+70 °C	-25...+70 °C
	Nickel-plated brass tube	Nickel-plated brass tube	Nickel-plated brass tube	Nickel-plated brass tube
	PBT	PBT	PBT	PBT
	Polyurethane foam, epoxy resin containing glass	Polyurethane foam, epoxy resin containing glass	Polyurethane foam, epoxy resin containing glass	Polyurethane foam, epoxy resin containing glass
	M12 connector, 5-pin	M12 connector, 5-pin	M12 connector, 5-pin	M12 connector, 5-pin

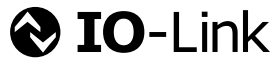
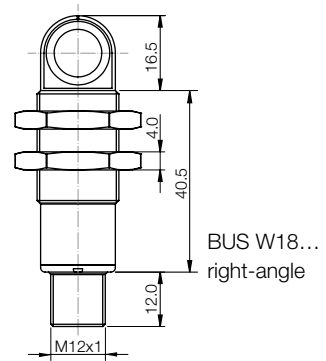
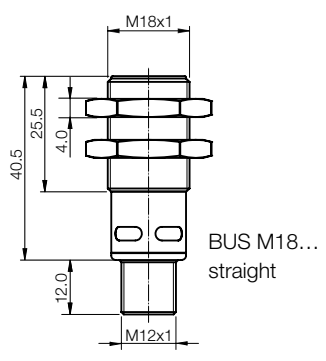

### IO-Link – the new standard

The IO-Link interface allows you to meet all of the prerequisites for gapless communication through all levels of the system architecture all the way to the sensor. Commissioning and maintenance of a machine are simplified and productivity increased.

**SmartLight – its broad color spectrum signals all common physical variables**

The first LED signal tower light with IO-Link interface uses its color spectrum to signal operating states. And it does this with many individually definable colors. The machine operator can have key and critical machine states displayed accurately as needed or as desired. And from its color scale, one can even read tendencies, patterns and trends of physical variables. Temperature statuses, levels of systems, or even the position of a slide over a position measuring system can be visualized on the tower light, which has up to 20 separately controllable LED circuits.

**Colors can be set individually for maximum flexibility**

Connection and installation are easy. All that is needed to screw them in is a four-wire sensor cable. That already gives you maximum functionality, so that the LED signal tower light provides previously unimagined benefits.

With the IO-Link SmartLight, almost all common physical variables can be shown with a flexible color spectrum via multicolored LEDs. They are programmed via the PLC in an incredibly simple way using bit address assignments of the IO-Link address range. Different colors can be assigned with a few commands, without having to mechanically change the LED tower lights.

Naturally, our SmartLight allows you to implement all of the functions that could be displayed for the user on systems previously available as well. Thus, for example, it is possible to display different colors in different zones, whereby the signal light can be subdivided in up to 5 zones. Quite unlike the systems previously on the market, these colors and zones can be specified individually in terms of number, size and color definition, and can even be changed "on the fly" while the machine is operating.

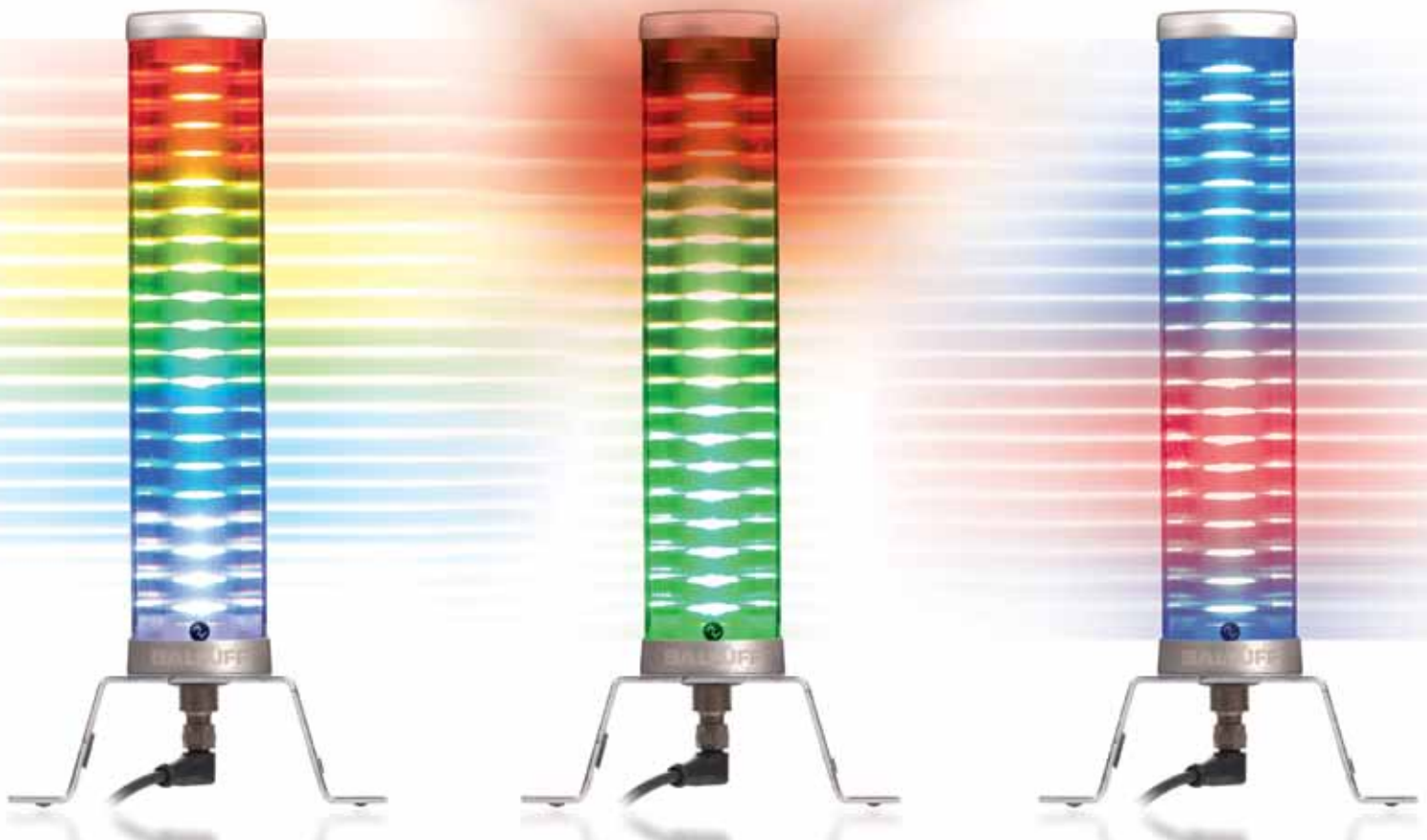

Holder not included in the standard scope of delivery.

**IO-Link SmartLight – the intelligent lamp**

- The first LED signal tower light with an IO-Link interface
- Maximum flexibility
- Very easy to program
- Extremely fast and easy to install
- Different colors can be easily assigned without having to mechanically change the LED tower lights

The SmartLight has three central function modes for displaying different warning and indicator signals. These can be controlled using the process data and SPDU index.

- Segment mode: Display of different color signals in up to five different segments
- Level mode: Color gradient display for showing aspects such as levels or temperature values
- Running light mode: Automatic running light with freely configurable foreground and background color

# IO-Link SmartLight

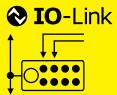

IO-Link  
Product  
topology  
M8 plastic  
sensor hubs  
M12 metal  
IO-Link  
sensor hubs  
M12 plastic  
IO-Link  
sensor hubs  
IO-Link sensor/  
actuator hubs  
M12 metal  
IO-Link  
actuator hubs  
**IO-Link  
sensors**  
IO-Link  
master  
Accessories

IO-Link	Device
Description	SmartLight
<b>Ordering code</b>	<b>BNI0072</b>
Part number	BNI IOL-802-000-Z036
Supply voltage $U_B$	18...30 V DC
Function indicator IO-Link RUN	Green LED
Power-on indicator	Green LED
Connection: IO-Link	M12, A-coded, male
Connection $U_A$	via IO-Link interface
Configurable	Yes
Max. load current of actuators	0.35 A
Degree of protection as per IEC 60529	IP 54 (only in plugged-in and screwed-down state)
Operating temperature $T_a$	-5...+70 °C
Storage temperature	-25...+70 °C
Fastener	M18 thread
Dimensions (L×W×H)	55×55×295 mm
Housing material	Transparent polycarbonate, nickel-plated die-cast zinc

## IO-Link Version 1.1

Transfer rate	COM 2 (38.4 kBaud)	
Cycle time	5 ms with IO-Link 1.1 Master 20 ms with IO-Link 1.0 Master	
Indicators	Communication	LED green flashing
	Power	Static green LED
IO-Link process data length		3 output byte

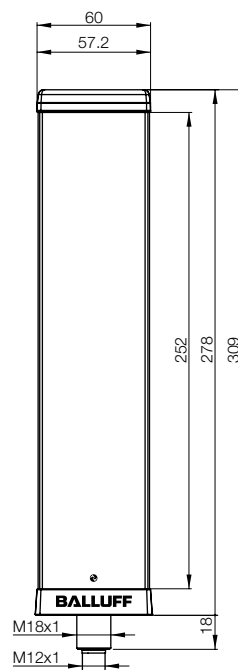

# IO-Link

## USB IO-Link master

Test and configure IO-Link devices using the **IO-Link Master Tool**.

You can now operate an IO-Link, access process parameters and import all service parameters separately from the controller. The USB port ensures that connecting to a laptop is easy. Software simplifies operation.

The supply voltage for IO-Link devices is provided directly via the USB port. An external power supply supplies power if more is needed.



Network		USB
1 × master + device	<b>Ordering code</b>	<b>BNI002U</b>
tool software	Part number	BNI USB-901-000-A501
Just box	<b>Ordering code</b>	<b>BNI0073</b>
	Part number	BNI USB-901-013-A501
Power-on indicator		Green LED
Connection: network		USB B female
Supply voltage connection		DC-9, 2.1 mm
Connection: IO-Link port		M12, A-coded
No. of IO-Link ports		1
Max. load current for IO-Link port		50 mA via USB/1.6 A via external power supply
USB status indicator		Green LED
Error diagnostic indicator		Red LED
Degree of protection as per IEC 60529		IP 40 (when attached)
Operating temperature T <sub>a</sub>		-5...+55 °C
Storage temperature		-25...+70 °C
Weight		Approx. 96 g
Fastener		none
Dimensions (L×W×H)		70×55×25 mm
Housing material		Al

### IO-Link

IO-Link	Master
Operating mode	SIO, COM 1, COM 2, COM 3
Communication indicator	Green LED

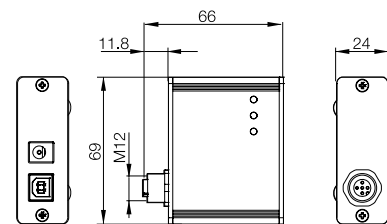

**Device tool software available separately on request.**

# IO-Link

## Device tool and software

The **USB master box** ensures that connecting to a laptop is easy, allowing you to configure and run diagnostics on any IO-Link device very easily using a computer.

The **device tool software** simplifies operation. Supply voltage for the IO-Link devices is provided directly through the USB port. An external power supply is used if more power is needed.

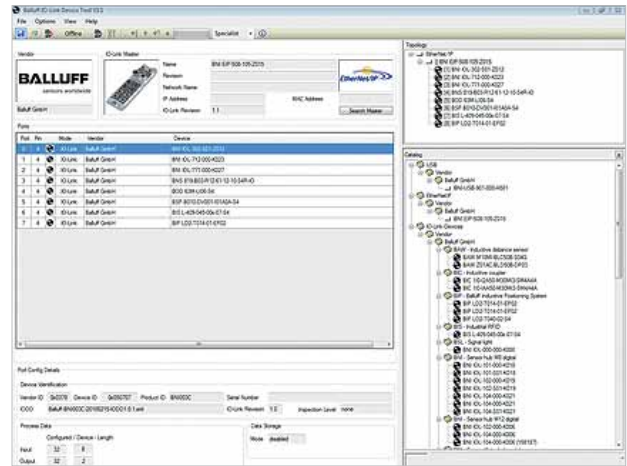

### Device tool software

Each IO-Link device delivery contains an IODD (Input Output Device Description). This electronic file can be used to import the data for the device into the **device tool software**. This means you can configure and run diagnostics on any IO-Link device.

The **device tool software** can be used to address any IO-Link device using the **USB master box**. But even the existing system

infrastructure can be used for communicating using the device tool software.

If you are using Ethernet-based IO-Link masters such as Balluff Profinet or Ethernet/IP IO-Link masters, you can establish a direct UDP connection from the **device tool software** to those modules. This provides direct access to each individual IO-Link port and allows you to configure and run diagnostics directly on all of the connected IO-Link devices.

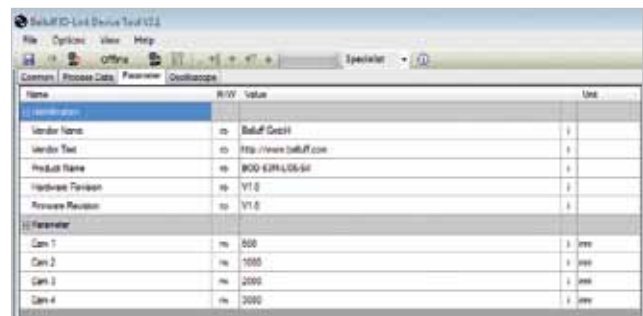
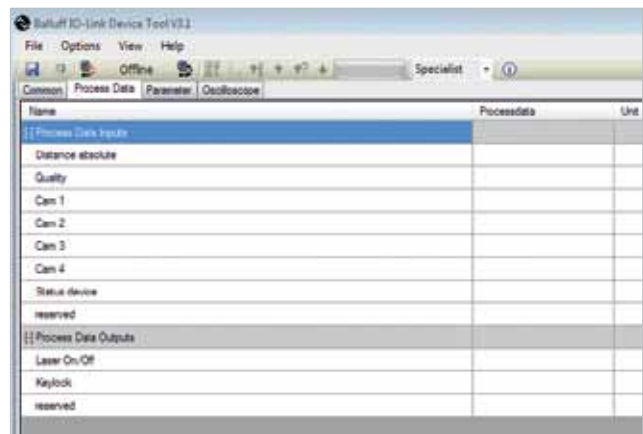

**IO-Link**

IO-Link  
Product  
topology  
M8 plastic  
IO-Link  
sensor hubs  
M12 metal  
IO-Link  
sensor hubs  
M12 plastic  
IO-Link  
sensor hubs  
IO-Link sensor/  
actuator hubs  
M12 metal  
IO-Link  
actuator hubs  
IO-Link  
sensors  
**IO-Link  
master**  
Accessories





Connector diagram and wiring			
Description	T splitter	Screw plug 7/8"	Screw plug 7/8"
Use	2x M12 female to 1x M12 male	Cover for the power ports	Cover for the power ports
<b>Ordering code</b>	<b>BCC089P</b>	<b>BAM012T</b>	<b>BAM012U</b>
Part number	BCC M415-M415-M415-U0003-000	BKS-7/8-CS-00-A	BKS-7/8-CS-00-I
Supply voltage $U_b$	125 V		
Rated operating current $I_o$	4 A		
Degree of protection as per IEC 60529	IP 67		
Ambient temperature $T_a$	-25...+80 °C	-20...+80 °C	-20...+80 °C
Housing material	PA 6.6 + GF	Nickel-plated CuZn	Nickel-plated CuZn

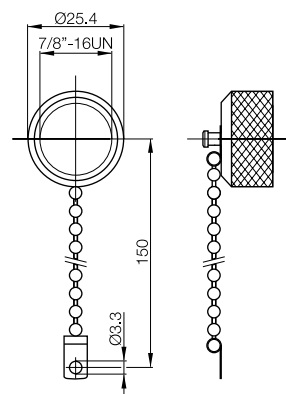
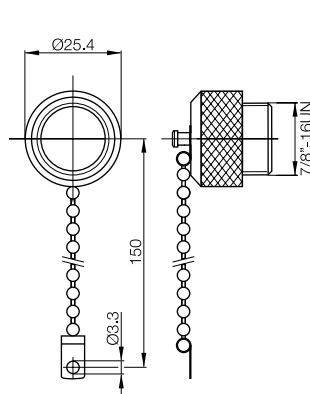
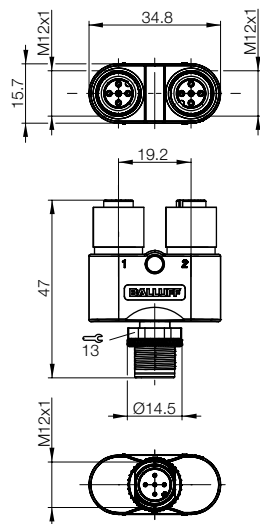





Description	M8 locking screw	M12 locking screw	Marking sleeve	Label set	Label set
Use	IP 65 threaded cover for unused ports	IP 65 threaded cover for unused ports	For labeling connectors	Port labels for modules BNI PBS..., BNI PNT..., BNI DNT..., BNI EIP..., BNI CCL...	Port labels for sensor hub BNI IOL...K006, BNI IOL...K018, BNI IOL...K021
<b>Ordering code</b>	<b>BAM01C1</b>	<b>BAM01C2</b>		<b>BAM01AT</b>	
Part number	BAM CS-XA-001-M8-C	BAM CS-XA-002-M12-A	BAM IA-CC-002-01	BNI ACC-L01-000	BSB ZM01-L01
Ambient temperature T <sub>a</sub>	-20...+80 °C	-20...+80 °C			
Housing material	Plastic	Plastic		Plastic	Plastic

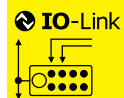

IO-Link  
Product topology  
M8 plastic IO-Link sensor hubs  
M12 metal IO-Link sensor hubs  
M12 plastic IO-Link sensor hubs  
IO-Link sensor/actuator hubs  
M12 metal IO-Link actuator hubs  
IO-Link sensors  
IO-Link master  
**Accessories**

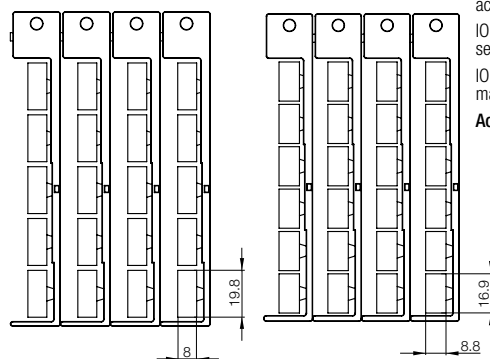
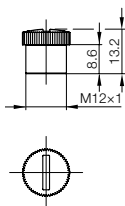
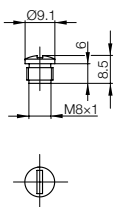

3-wire connector BCC; see the chapter "Connectors and Cables" beginning on **page 288**.



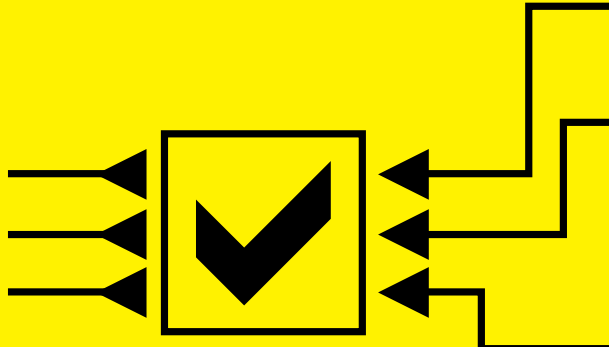

# Dynamic Sensor Control

## Dynamic Sensor Control: Condition monitoring

Reliable diagnostics are extremely important for highly dynamic machines. In the printing and paper machine industry, for example, the machine must react to faults within milliseconds.

Dynamic Sensor Control lets you recognize deviations in quality in the manufacturing process in real time, allowing you to implement corrective measures immediately.



# Dynamic Sensor Control Contents

Condition monitoring	194
Sensors	198

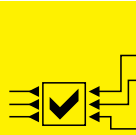

Knowledge

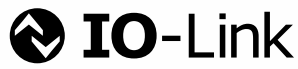

- Continuous signal
- Diagnostics
- Parameter configuration



Information

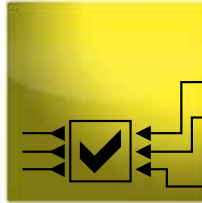

- Switching signal
- Diagnostics
- Warning messages



Data

Increase in diagnostic accuracy and functionality



- Switching signal
- Diagnostics

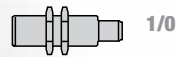
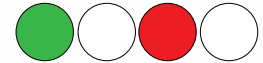

- Switching signal



# Dynamic Sensor Control

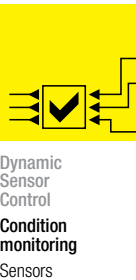
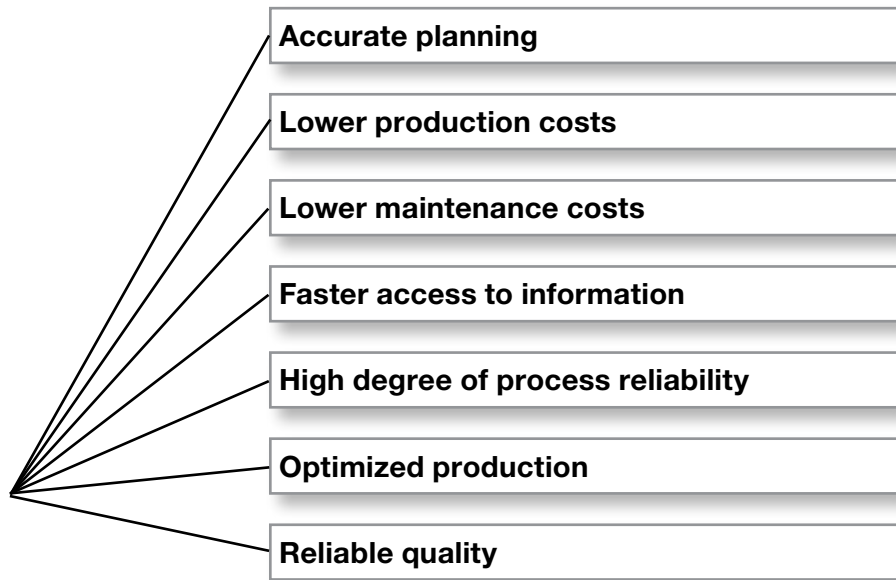

Reliable and timely detection of changing ambient conditions or machine states is often a decisive factor in being able to initiate repair actions in the production process in a timely manner. Dynamic Sensor Control (DSC) provides high-quality information in addition to the sensor function. This lets users immediately detect such aspects as whether detection ranges remain optimally configured or whether increasing contamination has started impairing the accuracy of a sensor, and does so during ongoing operations. This enables immediate correction. DSC increases the productivity of systems and machines.

**Σ Reduce your total cost of ownership**

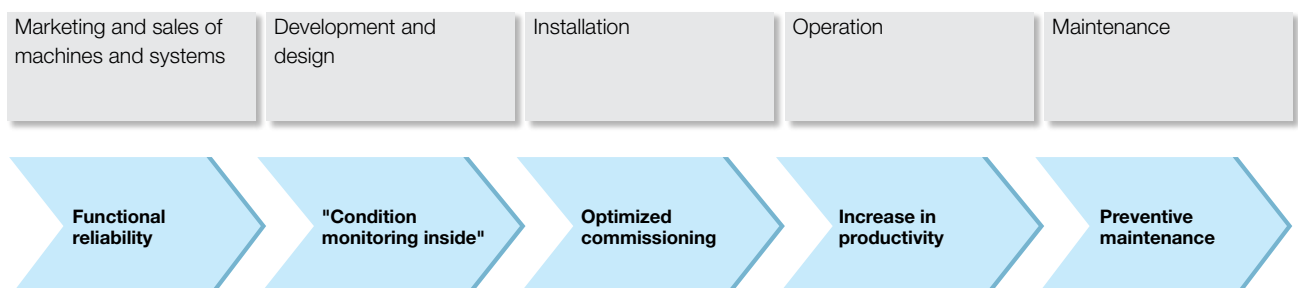

## Dynamic Sensor Control Condition monitoring

This compact IO-Link master module is equipped with four IO-Link ports that allow the connection of up to 32 DSC-compatible sensors in combination with DSC sensor hubs.

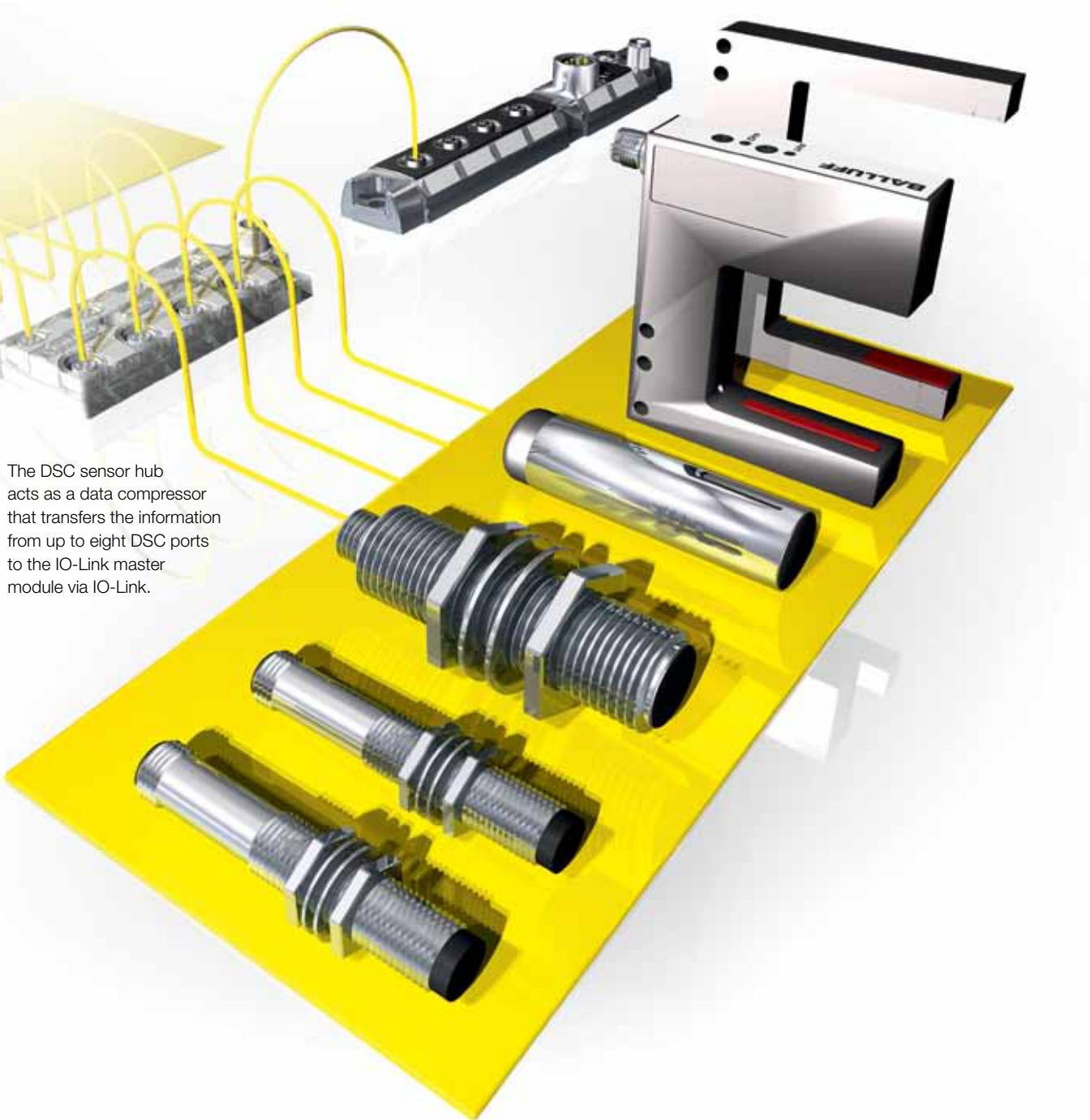

The DSC sensor hub acts as a data compressor that transfers the information from up to eight DSC ports to the IO-Link master module via IO-Link.



# Dynamic Sensor Control

## Condition monitoring

### Inductive high-end sensors

### Photoelectric high-end sensors

Target proximity  $> s_r$

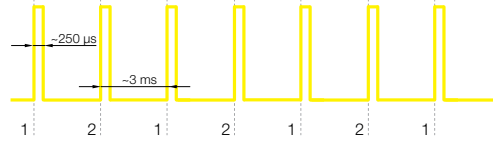
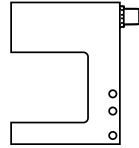
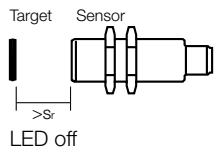

**Switching state OK**  
Output low

Target between  $s_a$  and  $s_r$  (typical)

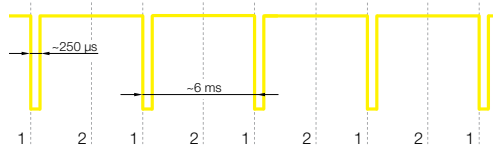
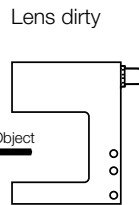
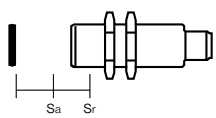

**Warning message**  
Output high

Target in the safe area

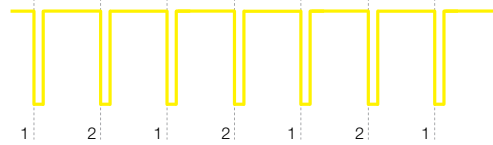
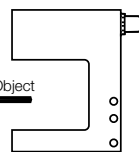
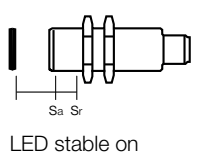

**Switching state OK**  
Output high

Target too close

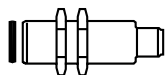

LED flashing frequency high

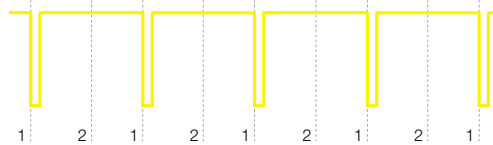

**Warning message**  
Output high

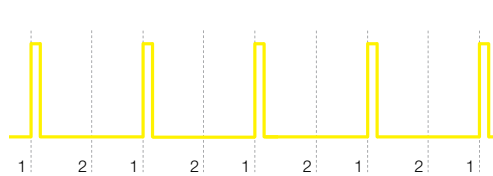
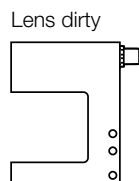

**Warning message**  
Output low

Sensor defective

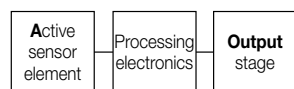

**Dynamic Sensor Control**

Diagnostics from **A** to **O**

Sensor defective

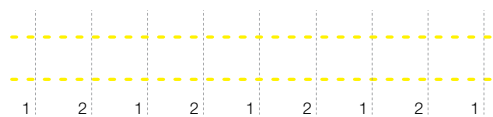

Coil break, fault in the processing electronics, output stage defective.

**Error**  
No pulses  
Output high or low

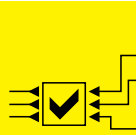

Dynamic Sensor Control  
Condition monitoring  
Sensors

## Capacitive Ø 20 mm sensor with Dynamic Sensor Control

Ordering code  
Part number



BCS0001  
BCS 20MG10-XPA1Y-8B-03

Switching type	PNP complementary	<input checked="" type="checkbox"/>			
Rated switching distance $s_n$	10 mm				
Size, installation type	Ø 20 mm, flush				
Supply voltage $U_B$	10...30 V DC				
Function indicator	Yes				
Degree of protection as per IEC 60529	IP 63				
Approvals	CE				
Housing material	V2A, EP				
Connection	3 m cable PUR, 3×0.25 mm <sup>2</sup>				

## Inductive M12 sensors with Dynamic Sensor Control

Ordering code  
Part number



BES02MC  
BES 113-356-SA6-S4  
BES02M5  
BES 113-3019-SA1-S4  
BES02M8  
BES 113-356-SA31-S4

Switching type	PNP NO PNP NC		<input checked="" type="checkbox"/>		
Rated switching distance $s_n$			3.7 mm	4 mm	
Size, installation type			M12×1, not flush		
Supply voltage $U_B$			20...30 V DC		
Function indicator			No		
Degree of protection as per IEC 60529			IP 67		
Approvals			CE		
Housing material			CuZn coated		
Connection			M12 connector		

### Classic capacitive sensors



Switching state: Target yes/no



Warning message: –



Error message: Sensor OK? Yes/No

### Classic inductive sensors



Switching state: Target yes/no



Warning message: –



Error message: Sensor OK? Yes/No



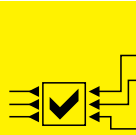

Dynamic Sensor Control  
Condition monitoring  
Sensors

## Inductive M08, M12, M18 and M30 sensors with Dynamic Sensor Control

Ordering code  
Part number



	BES03EN BES M08EH-PSY15B-S49G-D01	BES03EP BES M08EH-PSY25F-S49G-D01	BES03EL BES M08EH-PSY15B-S04G-D01	BES03EM BES M08EH1-PSY25F-S04G-D01	BES03ER BES M12MI-PSY20B-S04G-D01	BES03ET BES M12MH-PSY40F-S04G-D01	BES03EU BES M18MI-PSY50B-S04G-D01	BES03EW BES M18MG-PSY80F-S04G-D01	BES03EY BES M30MI-PSY10B-S04G-D01	BES03EZ BES M30MF1-PSY15F-S04G-D01
Size	M8	M8	M8	M8	M12	M12	M18	M18	M30	M30
Switching type	PNP NO									
Rated switching distance $s_n$	1.5 mm	2.5 mm	1.5 mm	2.5 mm	2 mm	4 mm	5 mm	8 mm	10 mm	15 mm
Installation type	Flush									
	Not flush									
Supply voltage $U_B$	18...30 V DC									
Function indicator	Yes									
Degree of protection as per IEC 60529	IP 67									
Approvals	CE, cULus									
Housing material	Stainless steel					CuZn coated				
Connection	M8, 3-pin		M12, 3-pin							

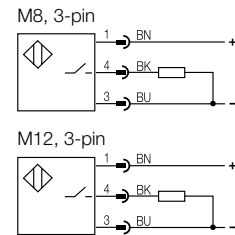

### High-end inductive sensors

- Switching state: Target yes/no
- Warning message: Target in critical area  
Function indicator flashes
- Error message: Sensor OK? Yes/No



## Fork sensors BGL with Dynamic Sensor Control

Ordering code  
Part number



		BGL0036	BGL003H	BGL003N	BGL003P	BGL003R
Fork sensor	1× PNP					
	2× PNP					
Fork opening	30 mm					
	50 mm					
	80 mm					
Light type	Red light					
	Infrared					
Function indicator		Yes				
Repeat accuracy		≤ 0.25 mm	≤ 0.15 mm			
Connection	Plug connector	M12, 4-pin	M8, 3-pin			

## Photoelectric sensor BOS 18M Teach-In with Dynamic Sensor Control

Ordering code  
Part number



		BOS01CU	BOS01CT	BOS01CW
Switching type	PNP NO/NC			
	Switchable			
Rated switching distance $s_n$		500 mm	5 m*	20 m
Size, installation type		M18		
Supply voltage $U_B$		10...30 V DC		
Function indicator		Yes		
Degree of protection as per IEC 60529		IP 67		
Housing material		Nickel-plated brass		
Connection		M12 connector		

\* based on reflector BOS R-1

### High-end photoelectric sensors



Switching state: Target yes/no



Warning message: Optical system dirty  
Function indicator flashes



Error message: Sensor OK? Yes/No



### High-end photoelectric sensors



Switching state: Target yes/no



Warning message: Optical system dirty  
Function indicator flashes



Error message: Sensor OK? Yes/No



# Dynamic Sensor Control Sensors



Fieldbus	Profibus DP
Version	4x IO-Link ports or 4 standard I/O ports
<b>Ordering code</b>	<b>BNI000Z</b>
Part number	BNI-PBS-507-000-Z011
Supply voltage $U_B$	18...30 V DC
Connection: Fieldbus	M12, B-coded
Supply voltage connection	7/8"
Connection: I/O ports	M12, A-coded, female
No. of I/O ports	4
Number of inputs	Max. 8
Number of outputs	Max. 8
Configurable	Yes
Max. load current, sensors/channel	200 mA
Max. load current, output	$\leq 1.6$ A
Total current $U_{Actuator}$	$\leq 9$ A
Total current $U_{Sensor}$	$\leq 9$ A
Degree of protection as per IEC 60529	IP 67 (when screwed into place)
Operating temperature $T_a$	-5...+55 °C
Storage temperature	-25...+70 °C
Dimensions (LxWxH)	224x37x32 mm
Housing material	Nickel-plated GdZn

### IO-Link

No. of IO-Link ports	4x master
Operating modes (3-wire)	SIO, COM 1, COM 2, COM 3
Communication indicator	Green LED
Error indicator	Red LED
Max. load current for IO-Link device	$\leq 1.6$ A

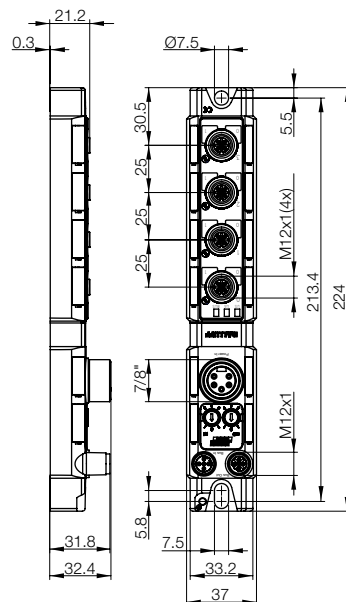

IO-Link	Device
Version	8x DSC or 8x I/O ports
<b>Ordering code</b>	<b>BNI002Z</b>
Part number	BNI IOL-530-000-K006
Supply voltage $U_B$	18...30 V DC
Connection: IO-Link	M12, A-coded, male
Connection: I/O ports	M12, A-coded, female
No. of I/O ports	8
No. of DSC ports	8
No. of digital inputs	8
Max. load current, sensors/channel	200 mA
Total current $U_T$	$< 1.2$ A
Degree of protection as per IEC 60529	IP 67 (when screwed into place)
Operating temperature $T_a$	-5...+55 °C
Storage temperature	-25...+85 °C
Dimensions (LxWxH)	115x50x31 mm
Housing material	PC

### IO-Link

Operating mode	COM 2
Parameter	<ul style="list-style-type: none"> <li>- Enable/disable DSC</li> <li>- DSC sensitivity</li> <li>- Diagnostics reset</li> <li>- NC/NO</li> </ul>

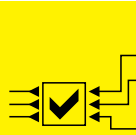

Dynamic  
Sensor  
Control  
Condition  
monitoring  
Sensors

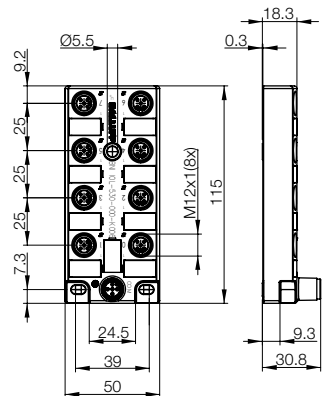

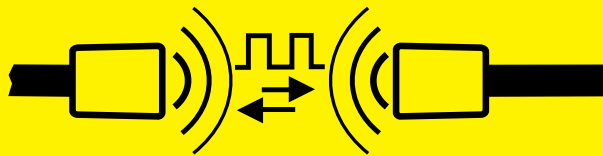

# Inductive Couplers

## Inductive Couplers

Balluff inductive couplers BIC are extremely suitable for the quick connection and disconnection of modules. New requirements can be implemented within a very short period and with maximum flexibility.

BIC couplers are installed immediately via plug-and-play, making retrofitting extremely simple. Even maintenance is significantly easier since cable breaks and mechanical wear are a thing of the past. The units can be disconnected quickly during maintenance. Power and signals are transferred reliably over an air gap.



# Inductive Couplers

## Contents

Overview	204
Applications	206
Programmable cams	210
Detector	211
Couplers for detectors	212
Unidirectional	214
Bidirectional	222
Radial system	225
Analog unidirectional	228
Single thermal	229
Terminal boxes	230
Rapid disconnection of power and signals	231
Power only	233
Uni-Standard and IO-Link	234
IO-Link unidirectional	237
Topology	238
Connectors	239



# Inductive Couplers

## Overview

Fixed wiring is a detriment when sensors are intended to follow the movements of a machine, as is the case in flexible automation. This puts heavy strain on contacts and cables.

These kinds of problems are a thing of the past thanks to inductive couplers BIC; signals and power are transmitted over an air gap without any contact.

### System components

- Sensor – mechanical, inductive, optical, magnetic or capacitive
- Remote – for connecting the sensors to the inductive system, installed on the mobile side
- Base – connects the system to the controller: transmits power to the remote, receives the status information from the sensor and relays it to the controller

### Power only

Power transmitting units for actuator systems, loading units or just supplying power

### Unidirectional systems

- Signal transfer from sensor to controller
- Up to 16 sensors are transmitted depending on the system
- Special systems for analog signals and PT100 measuring sensors

### Bidirectional systems

These systems transmit the signals in both directions.

### Active unit

- Mobile interface for the IO-Link environment
- This allows the use of IO-Link as the transmission protocol for all IO-Link-capable systems

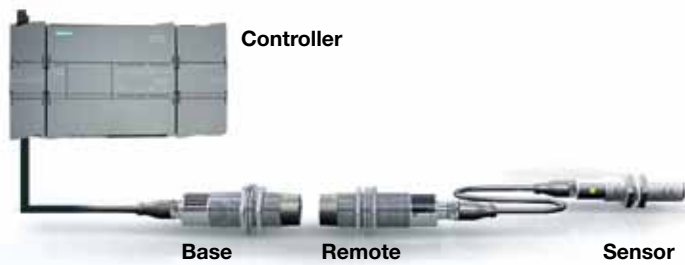

### Symbols

- Unidirectional, digital
- Bidirectional, digital
- Unidirectional, analog
- Power

Group	Series	Signal shape	Number of signals/ process data length	
Axial	Power only 	–	0	
Axial	Unidirectional 	digital	1	
		digital	1	
		digital	4	
		digital	4	
		digital	8	
		digital	8	
		digital	8	
		digital	8	
Axial		Analog	1	
		–	1	
Axial	Bidirectional 	digital	4+4	
Axial	Active unit 	IO-Link IN	3 bytes, 11 bytes	
Radial	Unidirectional 	digital	8	
		Analog	4	
Axial	Programmable cams 	–	1	

# Inductive Couplers

## Overview

	Design	Output voltage of remote	Output current of remote	Connection of	Remote (moving)	Base (stationary)	Page
	M30	24 V DC	500 mA	Consumer	<b>BIC0052</b> <b>BIC0008</b>	<b>BIC0051</b> <b>BIC0007</b>	233
	M12 + M18	–	–	Special detectors or mechanical switches	<b>BIC003W</b> <b>BIC003Z</b>	<b>BIC002T</b> <b>BIC002P</b>	212
	M18 + M30	12 V DC	30 mA	2-wire and 3-wire sensors, inductive	<b>BIC0012</b> <b>BIC000Y</b>	<b>BIC0011</b> <b>BIC000W</b>	213
	M18	12 V DC	30 mA	2-wire and 3-wire sensors, inductive, capacitive	<b>BIC002L</b> <b>BIC002K</b>	<b>BIC002C</b> <b>BIC0029</b>	214
	M30	12 V DC	40 mA	optical or mechanical	<b>BIC0044</b>	<b>BIC002E</b>	215
	M18 + M30	–	–	Special detectors or mechanical switches	<b>BIC001N</b> <b>BIC001T</b>	<b>BIC0069</b> <b>BIC0015</b> <b>BIC001A</b> <b>BIC001J</b>	218
	80×80×40	12 V DC	100 mA	2-wire and 3-wire sensors, inductive, capacitive, optical or mechanical	<b>BIC001Y</b>	<b>BIC0048</b> <b>BIC006A</b>	219
	M30	12 V DC	150 mA		<b>BIC0045</b>	<b>BIC0026</b> <b>BIC0027</b> <b>BIC0028</b>	221
	40×40×75	12 V DC	200 mA		<b>BIC0021</b> <b>BIC0022</b> <b>BIC0023</b>		220
	90×90×45	24 V DC	300 mA				221
	M18	18 V DC	15 mA	0...10 VDC	<b>BIC0043</b>	<b>BIC0046</b>	228
	M18	–	–	PT100	<b>BIC0041</b> <b>BIC004C</b>	<b>BIC0047</b>	229
	90×90×45	24 V DC	300 mA	2-wire and 3-wire sensors, inductive, capacitive, optical or mechanical	<b>BIC0039</b>	<b>BIC003C</b>	223
	M30 + Q40	24 V DC	500 mA	Sensor hub	<b>BIC000A</b>	<b>BIC0009</b>	234
	Ø 45	24 V DC	160 mA	2-wire and 3-wire sensors, inductive, capacitive, optical or mechanical	<b>BIC003P</b>	<b>BIC003N</b>	225
	Ø 45	18 V DC	180 mA	0...10 VDC	<b>BIC004A</b>	<b>BIC0049</b>	227
	M18 + M30	–	–	Mechanical switches	<b>BIC0004</b> <b>BIC0005</b> <b>BIC0006</b>	<b>BES01CE</b> <b>BES01CE</b> <b>BES0166</b>	210

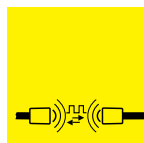

Inductive Couplers  
**Overview**  
 Applications  
 Programmable cams  
 Detectors  
 Couplers for detectors  
 Unidirectional  
 Bidirectional  
 Radial system type  
 Analog, unidirectional  
 Single thermal  
 Terminal boxes  
 Power and signals  
 Power only  
 Uni-Standard and IO-Link  
 IO-Link, unidirectional  
 Topology  
 Connectors



# Inductive Couplers Applications



## Load carrier: BIC as plug replacement

Sensors mounted on moving load carriers detect the presence of components.

The inductive coupling system takes over supplying power for the sensors and transmitting sensor signals, making mechanical contacts superfluous.

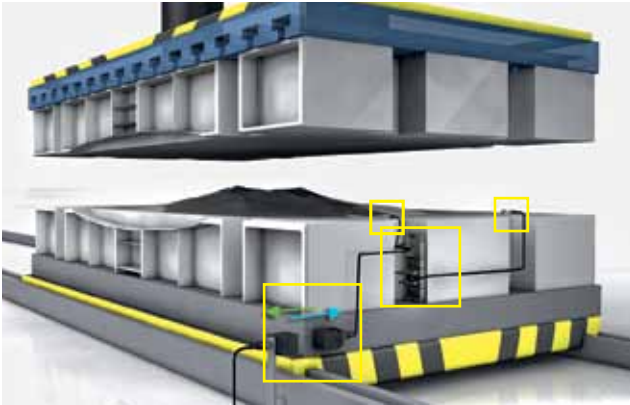

## Change tools: BIC as plug replacement and for tool identification

Sensors attached to change tools detect the presence of materials. The sensor signals are transmitted to the controller via the inductive couplers, thereby ensuring correct positioning of the material.

In conjunction with a networking interface BNI, tools can also be identified.

BIC couplers enable automatic tool changing since manually connecting mechanical connectors is unnecessary.



## Robotics: BIC as plug replacement on a robot's tool changer

Inductive couplers BIC make mechanical plug-in contacts unnecessary because the signals can be reliably transmitted over an air gap without contact. This ensures freedom from wear, guarantees tools are changed quickly and provides a large degree of flexibility and high dynamic response.

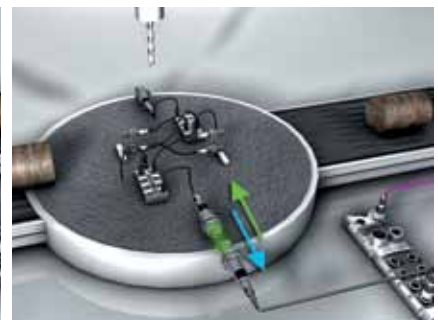

## Rotary table: BIC as replacement for slip rings and cable routing

Slip rings or cable connects are subjected to mechanical stress whenever sensor data has to be transmitted from a moving part to a stationary part (such as a turntable). Wear results in failures and expensive downtime.

Wirelessly operating BIC systems make slip rings and cable connections unnecessary on a rotary table. They transmit sensor signals and power for sensors.



## Machining center

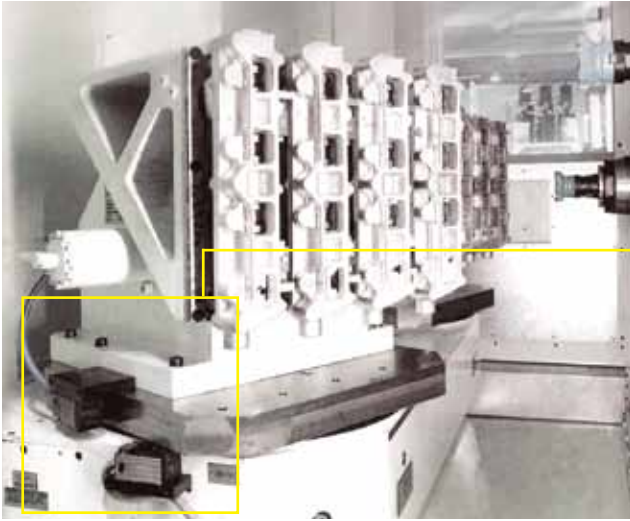

### Monitoring clamping jaws in the working area of a 2-spindle machining center.

Clamping jaws can also be monitored during machining using inductive couplers BIC. On a swinging table with two rotary indexing tables, 8 sensors on each indexing table transmit information without contact. Power for the sensor function is also provided inductively. The separable inductive coupling of power and signals also guarantees greater flexibility in machining centers.

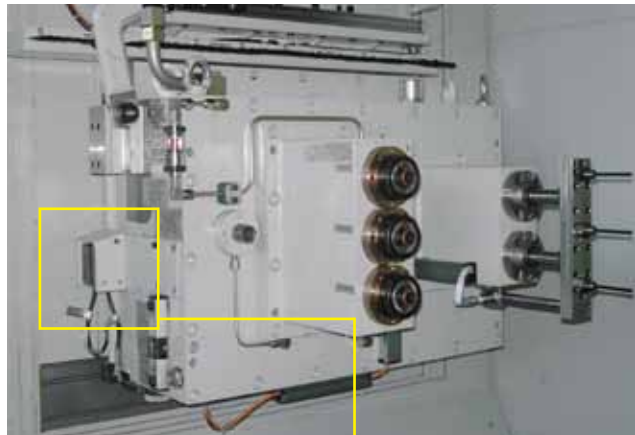

### Reliable workpiece position detection in machining centers at MTU Friedrichshafen

Inductive couplers BIC are used for independent workpiece detection on the pallet to deal with the variety of parts. Up to 16 sensors detect the positions and recognize the part to be machined based on certain features. After loading, the pallet is conveyed into the machining area where the recorded information is used to execute the machining program.

### Checking slide settings on an interchangeable drill head

The BIC system supplies power to inductive sensors and sends back sensor information. When the drill head is automatically changed, no connections need to be disconnected. The system operates using induction, allowing it to be disconnected quickly.

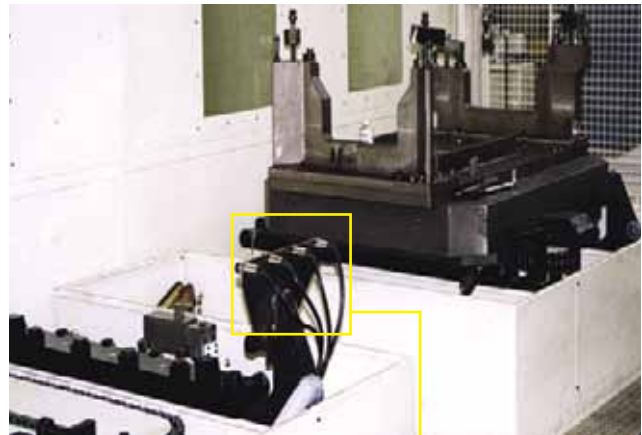

- Inductive Couplers
- Overview
- Applications**
- Programmable cams
- Detectors
- Couplers for detectors
- Unidirectional
- Bidirectional
- Radial system type
- Analog, unidirectional
- Single thermal
- Terminal boxes
- Power and signals
- Power only
- Uni-Standard and IO-Link
- IO-Link, unidirectional
- Topology
- Connectors

## Inductive Couplers Applications



### Robot gripper

The sensor determines whether the gripper has collected the workpiece. The switching state of the sensors is transmitted without contact.

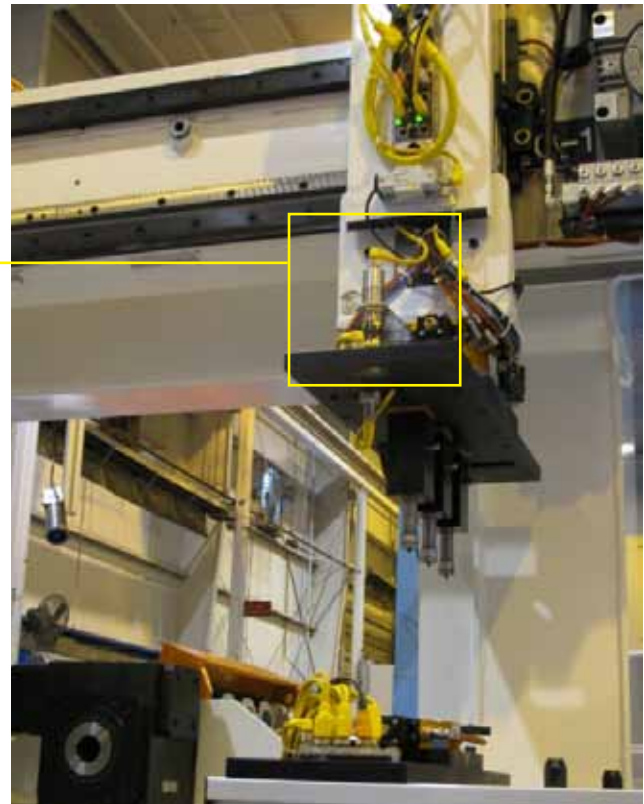

### Flexible production – wireless sensor/actuator connection for greater freedom of design

High-speed tool changes require signal transmission without contact. Inductive coupling with IO-Link is ideal for this task. When a tool is changed with BIC, no mechanical parts are required for signal contacting. There is no wear and no bad contacts.

# Inductive Couplers Applications



## Contactless transmission ensures a high number of cycles

Robots are indispensable for the precision loading and unloading of parts in machining centers. The high movement speed of the gripper often leads to problems with the sensor cabling. Federal Mogul Friedberg GmbH has taken on the problem and installed a radial BIC system at the interface between the gripper and robot arm. The energy for powering the sensors as well as the position information is inductively coupled.

This concept ensures reliable transmission, whether stationary or in motion.

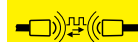

## Inductive Couplers

Overview

Applications

Programmable cams

Detectors

Couplers for detectors

Unidirectional

Bidirectional

Radial system type

Analog, unidirectional

Single thermal

Terminal boxes

Power and signals

Power only

Uni-Standard and IO-Link

IO-Link, unidirectional

Topology

Connectors

# Inductive Couplers

## Programmable cams

### M18, M30



Size	M18x1	M18x1	M30x1.5
Installation	Not flush	Not flush	Not flush
Rated switching distance $S_n$	<b>4 mm</b>	<b>4 mm</b>	<b>15 mm</b>
Assured switching distance $S_a$	1...3.5 mm	1...3.5 mm	5...10 mm
Programmable cams	3 m	3 m	3 m
Ordering code	<b>BIC0004</b>	<b>BIC0005</b>	<b>BIC0006</b>
Part number	BPN 18M-F-02-03	BPN 18M-F-03-PU-03	BPN 30M-B-04-PU-03
Ambient temperature $T_a$	-25...+70 °C	-25...+70 °C	-25...+70 °C
Degree of protection as per IEC 60529	IP 67	IP 67	IP 67
Housing material	Nickel-plated CuZn	Nickel-plated CuZn	Nickel-plated CuZn
Connection	PVC cable	PUR cable	PUR cable
Number of conductors × conductor cross-section	2×0.14 mm <sup>2</sup>	2×0.34 mm <sup>2</sup>	2×0.34 mm <sup>2</sup>

In combination with inductive sensor BES 516-326-B0-C-02, see Object detection catalog

In combination with inductive sensor BES 516-326-B0-C-02, see Object detection catalog

In combination with inductive sensor BES 516-114-G-S4-H, see Object detection catalog

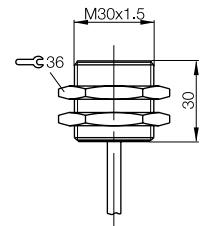
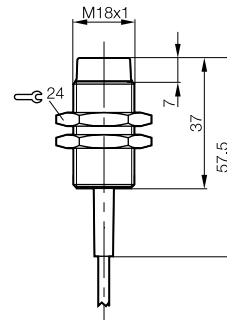
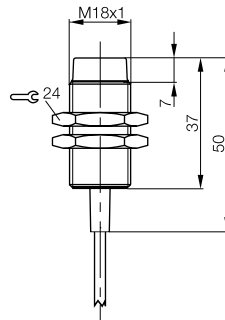

Simple principle for non-contact transmission of the switching state of a mechanical switch.

- Switch open, sensor damped
- Switch closed, sensor undamped

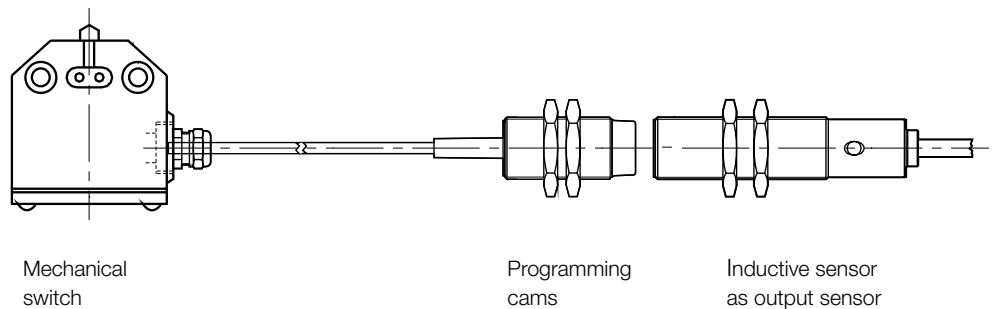

# Inductive Couplers Detector



Size	M8 x 1	M12x1	M18x1	M30x1.5
Installation	Flush	Flush	Flush	Flush
Rated switching distance $S_n$	<b>1.5 mm</b>	<b>2 mm</b>	<b>5 mm</b>	<b>10 mm</b>
Assured switching distance $S_a$	1.2 mm	1.6 mm	4.1 mm	8.1 mm
NO	<b>Ordering code</b>	<b>BIC004M</b>	<b>BIC004W</b>	<b>BIC0050</b>
1 m cable	Part number	BIC 915-D2-M08EE-EPX02-010	BIC 905-D2-M18ME-EPX02-010	BIC 910-D2-M30MF-EPX02-010
NO	<b>Ordering code</b>	<b>BIC004N</b>		
2 m cable	Part number	BIC 902-D2-M12ME-EPX02-020		
NO	<b>Ordering code</b>	<b>BIC004P</b>		
10 m cable	Part number	BIC 902-D2-M12ME-EPX02-100		
NO	<b>Ordering code</b>	<b>BIC004R</b>		
15 m cable	Part number	BIC 902-D2-M12ME-EPX02-150		
Ambient temperature $T_a$	0...+50 °C	0...+50 °C	0...+50 °C	0...+50 °C
Degree of protection as per IEC 60529	IP 67	IP 67	IP 67	IP 67
Housing material	Nickel-plated CuZn	Nickel-plated CuZn	Nickel-plated CuZn	Nickel-plated CuZn
Connection	PUR cable	PUR cable	PUR cable	PUR cable
Switching hysteresis H	≤ 20% of $s_r$	≤ 20% of $s_r$	≤ 20% of $s_r$	≤ 20% of $s_r$



Inductive Couplers  
Overview  
Applications  
**Programmable cams**  
**Detectors**  
Couplers for detectors  
Unidirectional  
Bidirectional  
Radial system type  
Analog, unidirectional  
Single thermal  
Terminal boxes  
Power and signals  
Power only  
Uni-Standard and IO-Link  
IO-Link, unidirectional  
Topology  
Connectors

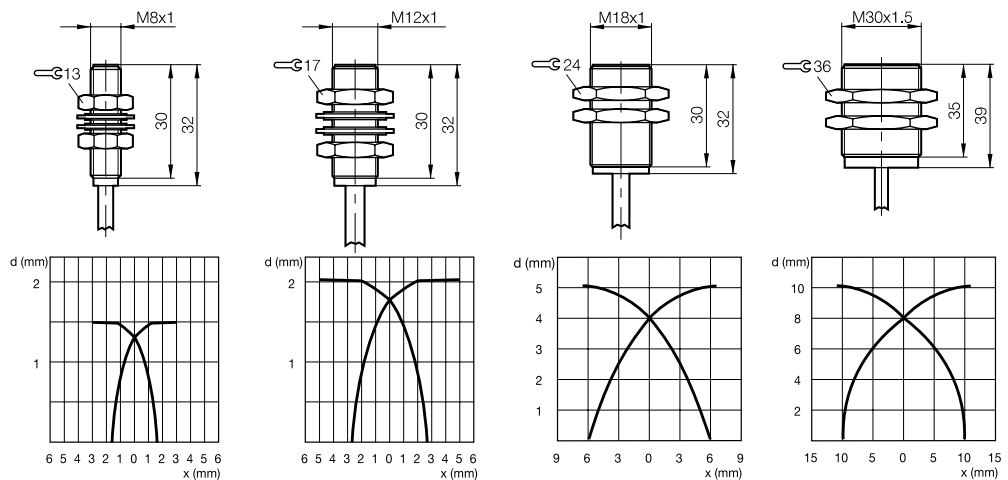

## Switching and transmission distances

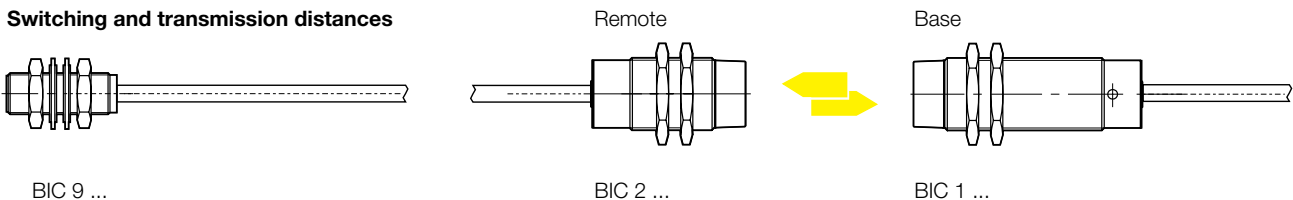

Detector			Remote			Base		
Ordering code	Size	Rated switching distance	Ordering code	Size	Transmission distance	Ordering code	Size	Output circuit
BIC004M	M8	1.5 mm						
BIC004N	M12	2 mm	BIC003W	M12	2 mm	BIC002T	M12	PNP/NO
BIC004W	M18	5 mm	BIC003Z	M18	5 mm	BIC002P	M18	PNP/NO
BIC0050	M30	10 mm						



# Inductive Couplers

## For one detector



### Connection for 1 detector (2-wire) or mechanical switch

	M12x1	M12x1	M18x1	M18x1
Size	M12x1	M12x1	M18x1	M18x1
Working range	2 mm		5 mm	
Installation	Not flush	Not flush	Not flush	Not flush
Remote <b>Ordering code</b>	<b>BIC003W</b>		<b>BIC003Z</b>	
5 m cable   Part number	BIC 210-D1001-M12ME1-BPX02-050		BIC 210-D1001-M18ME1-BPX02-050	
Base PNP <b>Ordering code</b>		<b>BIC002T</b>		<b>BIC002P</b>
5 m cable   Part number		BIC 110-P2001-M12MM1-BPX03-050		BIC 110-P2001-M18MI-BPX03-050
Supply voltage $U_b$ , including residual ripple		24 V $\pm$ 5%		24 V $\pm$ 5%
Rated operating current $I_o$		$\leq$ 100 mA		$\leq$ 100 mA
No-load supply current $I_o$ max.		$\leq$ 25 mA		$\leq$ 25 mA
Max. current load per output		$\leq$ 50 mA		$\leq$ 50 mA
Short-circuit protected		Yes		Yes
Rated insulation voltage $U_i$	75 V DC		75 V DC	
Operational readiness		40 ms		40 ms
Ambient temperature $T_a$	0...+50 °C	0...+50 °C	0...+50 °C	0...+50 °C
Storage temperature	-25...+75 °C	-25...+75 °C	-25...+75 °C	-25...+75 °C
Switching frequency f		25 Hz		25 Hz
Function/supply voltage indicator		Yes		Yes
Tightening torque	15 Nm	15 Nm	40 Nm	40 Nm
Degree of protection as per IEC 60529	IP 67	IP 67	IP 67	IP 67
Housing material	Nickel-plated CuZn	Nickel-plated CuZn	Nickel-plated CuZn	Nickel-plated CuZn
Material of sensing face	ABS/PBT	ABS/PBT	PA 12	PA 12
Connection	PUR cable	PUR cable	PUR cable	PUR cable
Number of conductors $\times$ conductor cross-section	2 $\times$ 0.5 mm <sup>2</sup>	3 $\times$ 0.3 mm <sup>2</sup>	2 $\times$ 0.5 mm <sup>2</sup>	3 $\times$ 0.3 mm <sup>2</sup>

We ask that you request the user's guide for your electrical project planning.

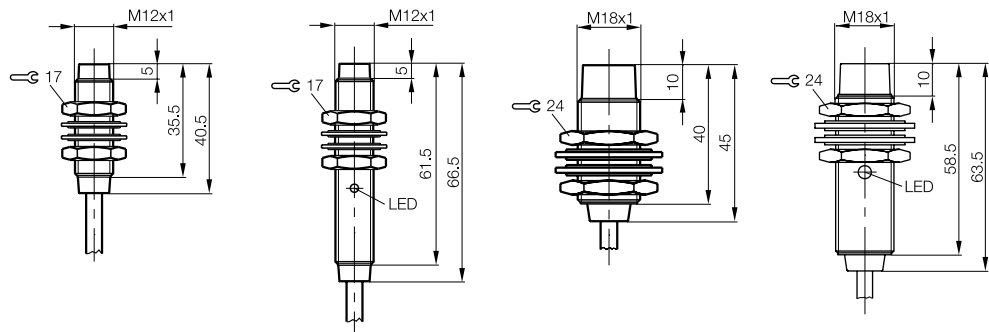

### Switching and transmission distances

Detector			Remote			Base		
Ordering code	Size	Rated switching distance	Ordering code	Size	Transmission distance	Ordering code	Size	Output circuit
BIC004M	M8	1.5 mm	BIC003W	M12	2 mm	BIC002T	M12	PNP/NO
BIC004N	M12	2 mm		BIC003Z	M18		5 mm	M18
BIC004W	M18	5 mm						
BIC0050	M30	10 mm						



# Inductive Couplers

## For up to eight detectors



Connection for max. 8 detectors or mechanical switches			
M18x1	M18x1	M30x1.5	M30x1.5
5 mm		10 mm	
Not flush	Not flush	Not flush	Not flush
<b>BIC0012</b>		<b>BIC000Y</b>	
BIC 2I3-P2A40-M18MF2-BPX09-050		BIC 2I3-P2A40-M30ME2-BPX09-050	
	<b>BIC0011</b>		<b>BIC000W</b>
	BIC 1I3-P2A40-M18MN2-BPX0B-050		BIC 1I3-P2A40-M30M02-BPX0B-050
	24 V ±5%		24 V ±5%
	≤ 100 mA		≤ 100 mA
	≤ 25 mA		≤ 25 mA
	≤ 50 mA		≤ 50 mA
	Yes		Yes
75 V DC		75 V DC	
	300 ms		300 ms
0...+50 °C	0...+50 °C	0...+50 °C	0...+50 °C
-25...+75 °C	-25...+75 °C	-25...+75 °C	-25...+75 °C
	3.2 Hz		3.2 Hz
	Yes		Yes
40 Nm	40 Nm	40 Nm	40 Nm
IP 67	IP 67	IP 67	IP 67
Nickel-plated CuZn	Nickel-plated CuZn	Nickel-plated CuZn	Nickel-plated CuZn
PA 12	PA 12	PA 12	PA 12
PVC cable	PVC cable	PVC cable	PVC cable
12x0.18 mm <sup>2</sup>	12x0.18 mm <sup>2</sup>	12x0.18 mm <sup>2</sup>	12x0.18 mm <sup>2</sup>

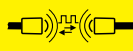

Inductive Couplers  
 Overview  
 Applications  
 Programmable cams  
 Detectors  
**Couplers for detectors**  
 Unidirectional  
 Bidirectional  
 Radial system type  
 Analog, unidirectional  
 Single thermal  
 Terminal boxes  
 Power and signals  
 Power only  
 Uni-Standard and IO-Link  
 IO-Link, unidirectional  
 Topology  
 Connectors

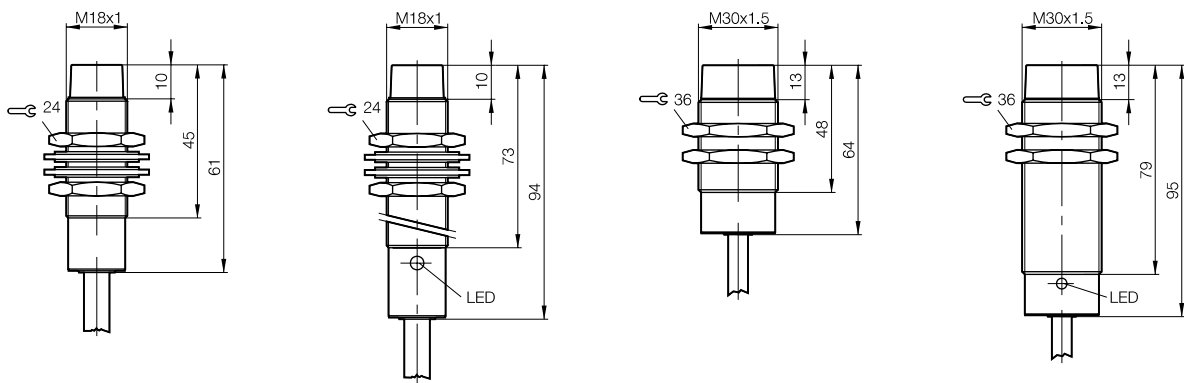

Detector			Remote			Base			
Ordering code	Size	Rated switching distance	Ordering code	Size	Transmission distance	Ordering code	Size	Output circuit	
BIC004M	M8	1.5 mm		BIC003W	M12	2 mm	BIC002T	M12	PNP/NO
BIC004N	M12	2 mm		BIC003Z	M18	5 mm	BIC002P	M18	PNP/NO
BIC004W	M18	5 mm							
BIC0050	M30	10 mm							

# Inductive Couplers

## Unidirectional for one sensor



### Connection for 1 sensor

Size	M18x1	M18x1
Working range	<b>2.5 mm</b>	
Installation	Not flush	Not flush
Remote NPN	<b>Ordering code</b>	
1 m cable	Part number	
Remote PNP	<b>Ordering code</b>	
2 m cable	Part number	
Remote PNP	<b>Ordering code</b>	
3 m cable	Part number	
Base NPN	<b>Ordering code</b>	<b>BIC002C</b>
2 m cable	Part number	BIC 110-N2A02-M18MI-BPX03-020
Base PNP	<b>Ordering code</b>	<b>BIC0029</b>
5 m cable	Part number	BIC 110-P2A02-M18MI-BPX03-050
Supply voltage $U_b$ , including residual ripple		24 V DC $\pm 5\%$
Rated operating current $I_o$		$\leq 250$ mA
No-load supply current $I_o$ max.		$\leq 150$ mA
Max. current load per output		$\leq 50$ mA
Short-circuit protected		Yes
Remote output voltage	12 $\pm 1.5$ V DC	
Power supply, continuous output current	$\leq 30$ mA	
Rated insulation voltage $U_i$	75 V DC	
Operational readiness		40 ms
Ambient temperature $T_a$	0...+50 °C	0...+50 °C
Storage temperature	-25...+75 °C	-25...+75 °C
Offset	$\pm 2$ mm	
Switching frequency $f$		25 Hz
Function/power-on indicator		Yes/Yes
Tightening torque	40 Nm	40 Nm
Degree of protection as per IEC 60529	IP 67	IP 67
Housing material	Nickel-plated CuZn	Nickel-plated CuZn
Material of sensing face	ABS/PBT	ABS/PBT
Connection	PUR cable	PUR cable
Number of conductors $\times$ conductor cross-section	3 $\times$ 0.34 mm <sup>2</sup>	3 $\times$ 0.34 mm <sup>2</sup>

We ask that you request the user's guide for your electrical project planning.

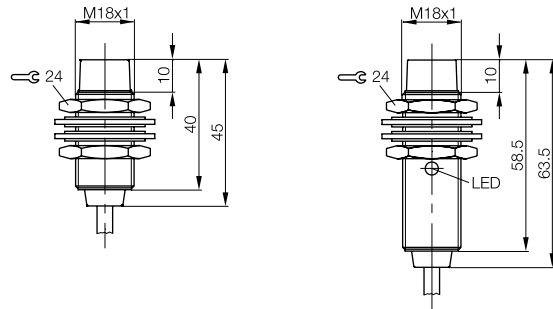



# Inductive Couplers

## Unidirectional for one sensor



	M30x1.5	M30x1.5		
	4.5 mm			
	Not flush	Not flush		
	<b>BIC0044</b>			
	BIC 2I0-P2A05-M30MF-BPX03-030			
		<b>BIC002E</b>		
		BIC 1I0-P2A02-M30MI-BPX03-050		
		24 V DC ±5%		
		≤ 250 mA		
		≤ 150 mA		
		≤ 50 mA		
		Yes		
	12 ±1.5 V DC			
	≤ 30 mA			
	75 V DC			
	0...+50 °C	40 ms		
	-25...+75 °C	0...+50 °C		
	±3 mm	-25...+75 °C		
		25 Hz		
		Yes/Yes		
	40 Nm	40 Nm		
	IP 67	IP 67		
	Nickel-plated CuZn	Nickel-plated CuZn		
	ABS/PBT	ABS/PBT		
	PUR cable	PUR cable		
	3x0.34 mm <sup>2</sup>	3x0.34 mm <sup>2</sup>		

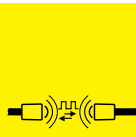

- Inductive Couplers
- Overview
- Applications
- Programmable cams
- Detectors
- Couplers for detectors
- Unidirectional**
- Bidirectional
- Radial system type
- Analog, unidirectional
- Single thermal
- Terminal boxes
- Power and signals
- Power only
- Uni-Standard and IO-Link
- IO-Link, unidirectional
- Topology
- Connectors

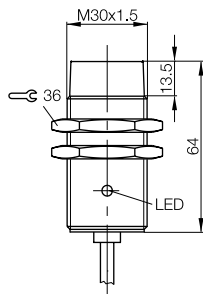
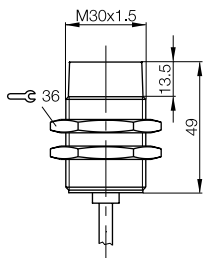

# Inductive Couplers

## Unidirectional for one sensor



### Connection for 1 sensor (Teflon-coated housing)

Size	M18x1	M18x1	
Working range	<b>2.5 mm</b>		
Installation	Not flush	Not flush	
Remote PNP	<b>Ordering code</b>		
3 m cable	Part number		
Remote DC-2 wire	<b>Ordering code</b>		
3 m cable	Part number		
Remote NPN	<b>Ordering code</b>	<b>BIC005P</b>	
5 m cable	Part number	BIC 210-N2A02-M18TI-BPX03-050	
Remote DC-2 wire	<b>Ordering code</b>	<b>BIC005R</b>	
5 m cable	Part number	BIC 210-D2A02-M18TI-BPX03-050	
Base NPN	<b>Ordering code</b>		
3 m cable	Part number		
Base PNP	<b>Ordering code</b>		
3 m cable	Part number		
Base NPN	<b>Ordering code</b>		<b>BIC005T</b>
5 m cable	Part number		BIC 110-N2A02-M18TI-BPX03-050
Supply voltage $U_b$ , including residual ripple			24 V DC $\pm 5\%$
Rated operating current $I_o$			$\leq 250$ mA
No-load supply current $I_o$ max.			$\leq 150$ mA
Max. current load per output			$\leq 50$ mA
Short-circuit protected			Yes
Remote output voltage	12 $\pm 1.5$ V DC		
Power supply, continuous output current	$\leq 30$ mA		
Rated insulation voltage $U_i$	75 V DC		
Operational readiness			40 ms
Ambient temperature $T_a$	0...+50 °C		0...+50 °C
Storage temperature	-25...+75 °C		-25...+75 °C
Offset	$\pm 2$ mm		
Switching frequency $f$			25 Hz
Function/power-on indicator			Yes/Yes
Tightening torque	40 Nm		40 Nm
Degree of protection as per IEC 60529	IP 67		IP 67
Housing material	Teflon		Teflon
Material of sensing face	ABS/PBT		ABS/PBT
Connection	PUR cable		PUR cable
Number of conductors $\times$ conductor cross-section	3 $\times$ 0.34 mm <sup>2</sup>		3 $\times$ 0.34 mm <sup>2</sup>

We ask that you request the user's guide for your electrical project planning.

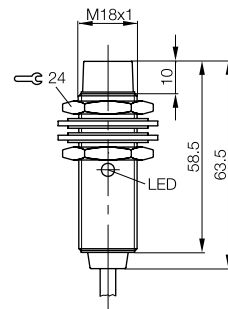
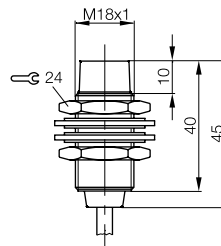

# Inductive Couplers

## Unidirectional for one sensor

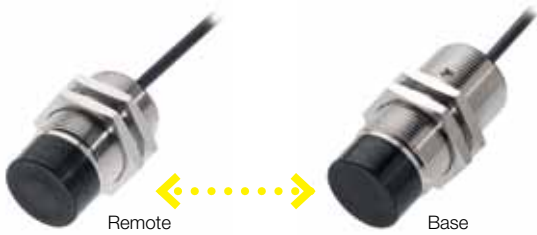

	M30x1.5	M30x1.5		
	<b>4.5 mm</b>			
	Not flush	Not flush		
	<b>BIC005K</b>			
	BIC 210-P2A02-M30TI-BPX03-030			
	<b>BIC005M</b>			
	BIC 210-D2A02-M30TI-BPX03-030			
		<b>BIC005N</b>		
		BIC 110-N2A02-M30TI-BPX03-030		
		<b>BIC005L</b>		
		BIC 110-P2A02-M30TI-BPX03-030		
		24 V DC $\pm 5\%$		
		$\leq 250$ mA		
		$\leq 150$ mA		
		$\leq 50$ mA		
		Yes		
	12 $\pm$ 1.5 V DC			
	$\leq 30$ mA			
	75 V DC			
	0...+50 °C	40 ms		
	-25...+75 °C	0...+50 °C		
	$\pm 3$ mm	-25...+75 °C		
		25 Hz		
		Yes/Yes		
	40 Nm	40 Nm		
	IP 67	IP 67		
	Teflon	Teflon		
	ABS/PBT	ABS/PBT		
	PUR cable	PUR cable		
	3x0.34 mm <sup>2</sup>	3x0.34 mm <sup>2</sup>		



- Inductive Couplers
- Overview
- Applications
- Programmable cams
- Detectors
- Couplers for detectors
- Unidirectional**
- Bidirectional
- Radial system type
- Analog, unidirectional
- Single thermal
- Terminal boxes
- Power and signals
- Power only
- Uni-Standard and IO-Link
- IO-Link, unidirectional
- Topology
- Connectors

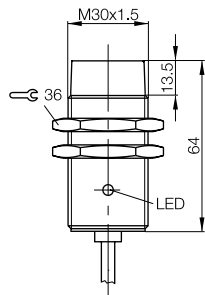
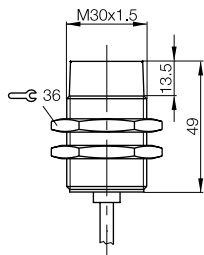

# Inductive Couplers

## Unidirectional for up to four sensors



### for max. 4 sensors

	M18x1	M18x1	M30x1.5	M30x1.5
Size	M18x1	M18x1	M30x1.5	M30x1.5
Working range	3 mm		5 mm	
Installation	Not flush	Not flush	Not flush	Not flush
Remote PNP	<b>Ordering code</b> <b>BIC001N</b>		<b>BIC001T</b>	
5 m cable	Part number BIC 2I2-P2A02-M18MF2-EPX07-050		BIC 2I2-P2A03-M30MF2-EPX07-050	
Base NPN	<b>Ordering code</b>	<b>BIC0069</b>		
5 m cable	Part number	BIC 1I2-N1A02-M18MN2-EPX07-050		
Base PNP	<b>Ordering code</b>	<b>BIC0015</b>		<b>BIC001A</b>
5 m cable	Part number	BIC 1I2-P2A02-M18MN2-EPX07-050		BIC 1I2-P2A03-M30MQ2-EPX07-050
Supply voltage $U_B$ including residual ripple		24 V DC $\pm 5\%$		24 V DC $\pm 5\%$
Rated operating current $I_o$		$\leq 700$ mA		$\leq 700$ mA
No-load supply current $I_o$ max.		$\leq 170$ mA		$\leq 150$ mA
Max. current load per output		$\leq 50$ mA		$\leq 50$ mA
Short-circuit protected		Yes		Yes
Remote output voltage	12 $\pm 1.5$ V DC		12 $\pm 1.5$ V DC	
Power supply, continuous output current	$\leq 30$ mA		$\leq 40$ mA	
Rated insulation voltage $U_i$	75 V DC		75 V DC	
Operational readiness		40 ms		40 ms
Ambient temperature $T_a$	0...+50 °C	0...+50 °C	0...+50 °C	0...+50 °C
Storage temperature	-25...+75 °C	-25...+75 °C	-25...+75 °C	-25...+75 °C
Offset	$\pm 2$ mm		$\pm 4$ mm	
Switching frequency $f$		30 Hz		30 Hz
Function/supply voltage indicator		Yes/Yes		Yes/Yes
Tightening torque	40 Nm	40 Nm	40 Nm	40 Nm
Degree of protection as per IEC 60529	IP 67	IP 67	IP 67	IP 67
Housing material	Nickel-plated CuZn	Nickel-plated CuZn	Nickel-plated CuZn	Nickel-plated CuZn
Material of sensing face	PA 12	PA 12	PA 12	PA 12
Connection	PUR cable	PUR cable	PUR cable	PUR cable
Number of conductors $\times$ conductor cross-section	7 $\times$ 0.3 mm <sup>2</sup>	7 $\times$ 0.3 mm <sup>2</sup>	7 $\times$ 0.3 mm <sup>2</sup>	7 $\times$ 0.3 mm <sup>2</sup>

We ask that you request the user's guide for your electrical project planning.

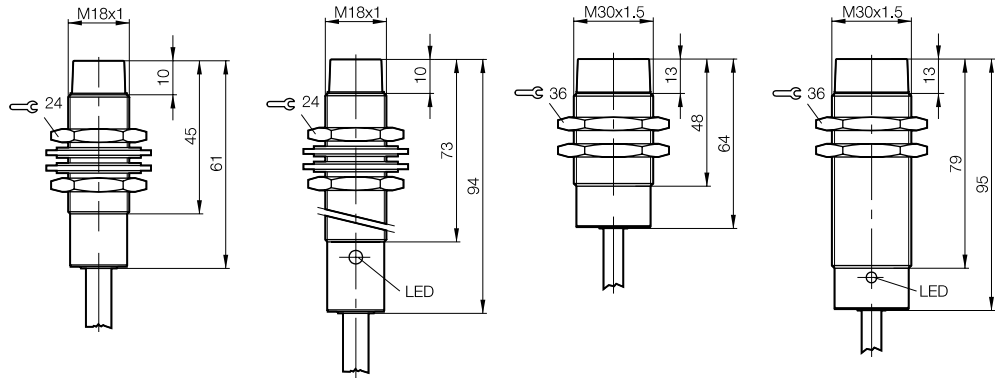

# Inductive Couplers

## Unidirectional for up to eight sensors



Connection for max. 8 sensors	
<b>80x80x40 mm</b>	<b>80x80x40 mm</b>
<b>10 mm</b>	
Not flush	Not flush
<b>BIC001Y</b>	
BIC 2I3-P2A05-Q80KA-GPX0C-050	
	<b>BIC001J</b>
	BIC 1I3-P2A05-Q80KA-GPX0C-050
	24 V DC ±5%
	≤ 950 mA
	≤ 300 mA
	≤ 50 mA
	Yes
12 ±1.5 V DC	
≤ 100 mA	
75 V DC	
0...+50 °C	40 ms
-25...+75 °C	0...+50 °C
±6 mm	-25...+75 °C
	30 Hz
	Yes/Yes
IP 67	IP 67
PBT	PBT
PBT	PBT
PUR cable	PUR cable
12x0.18 mm <sup>2</sup>	12x0.18 mm <sup>2</sup>

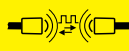

- Inductive Couplers
- Overview
- Applications
- Programmable cams
- Detectors
- Couplers for detectors
- Unidirectional**
- Bidirectional
- Radial system type
- Analog, unidirectional
- Single thermal
- Terminal boxes
- Power and signals
- Power only
- Uni-Standard and IO-Link
- IO-Link, unidirectional
- Topology
- Connectors

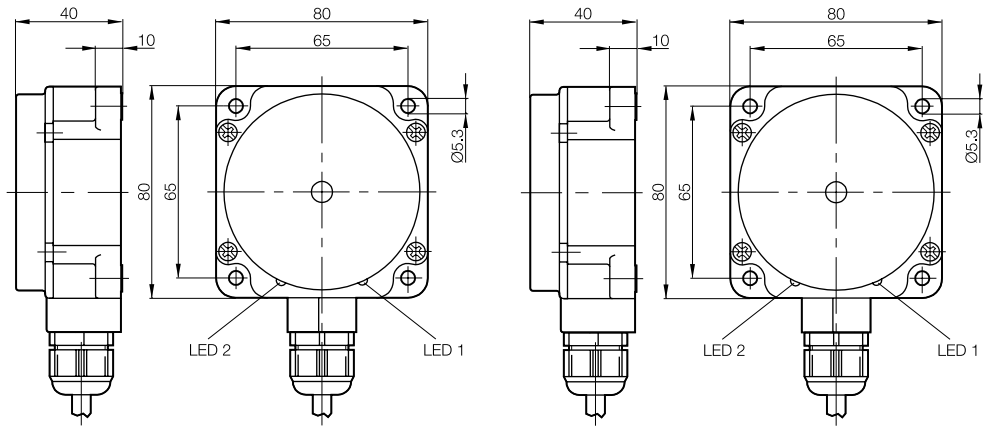

# Inductive Couplers

## Unidirectional, power for up to eight sensors

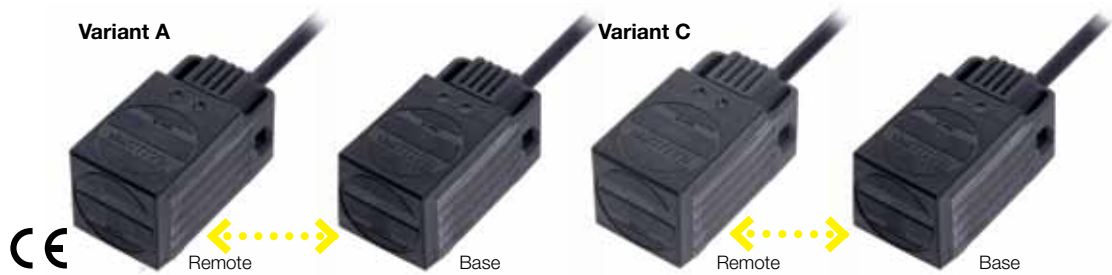

### Connection for max. 8 sensors

	40x75x40 mm	40x75x40 mm	40x75x40 mm	40x75x40 mm
Size	40x75x40 mm	40x75x40 mm	40x75x40 mm	40x75x40 mm
Working range	8 mm		8 mm	
Installation	Not flush	Not flush	Not flush	Not flush
Remote PNP	<b>Ordering code</b> <b>BIC0021</b>		<b>BIC0022</b>	
5 m cable	Part number BIC 2I3-P2A20-Q40AA-GPX0B-050		BIC 2I3-P2A20-Q40AC-GPX0B-050	
Base PNP	<b>Ordering code</b>	<b>BIC0026</b>		<b>BIC0027</b>
5 m cable	Part number	BIC 1I3-P2A20-Q40AA-GPX0B-050		BIC 1I3-P2A20-Q40AC-GPX0B-050
Base NPN	<b>Ordering code</b>			
5 m cable	Part number			
Supply voltage $U_B$ including residual ripple		24 V DC $\pm 10\%$		24 V DC $\pm 10\%$
Rated operating current $I_o$		$\leq 1.2$ A		$\leq 1.2$ A
No-load supply current $I_o$ max.		$\leq 500$ mA		$\leq 500$ mA
Max. current load per output		$\leq 50$ mA		$\leq 50$ mA
Short-circuit protected		Yes		Yes
Remote output voltage	12 $\pm 1.5$ V DC		12 $\pm 1.5$ V DC	
Power supply, continuous output current	$\leq 200$ mA		$\leq 200$ mA	
Rated insulation voltage $U_i$	75 V DC		75 V DC	
Operational readiness		20 ms		20 ms
Ambient temperature $T_a$	0...+50 °C	0...+50 °C	0...+50 °C	0...+50 °C
Storage temperature	-25...+75 °C	-25...+75 °C	-25...+75 °C	-25...+75 °C
Offset	$\pm 3$ mm		$\pm 3$ mm	
Switching frequency $f$		60 Hz		60 Hz
Function/supply voltage indicator		Yes/Yes		Yes/Yes
Tightening torque	40 Nm	40 Nm	40 Nm	40 Nm
Degree of protection as per IEC 60529	IP 67	IP 67	IP 67	IP 67
Housing material	Al	Al	Al	Al
Material of sensing face	ABS/PBT	ABS/PBT	ABS/PBT	ABS/PBT
Connection	PUR cable	PUR cable	PUR cable	PUR cable
Number of conductors $\times$ conductor cross-section	9 $\times$ 0.18 mm <sup>2</sup> + 2 $\times$ 0.5 mm <sup>2</sup>	9 $\times$ 0.18 mm <sup>2</sup> + 2 $\times$ 0.5 mm <sup>2</sup>	9 $\times$ 0.18 mm <sup>2</sup> + 2 $\times$ 0.5 mm <sup>2</sup>	9 $\times$ 0.18 mm <sup>2</sup> + 2 $\times$ 0.5 mm <sup>2</sup>

We ask that you request the user's guide for your electrical project planning.

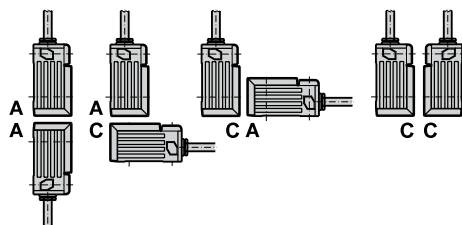
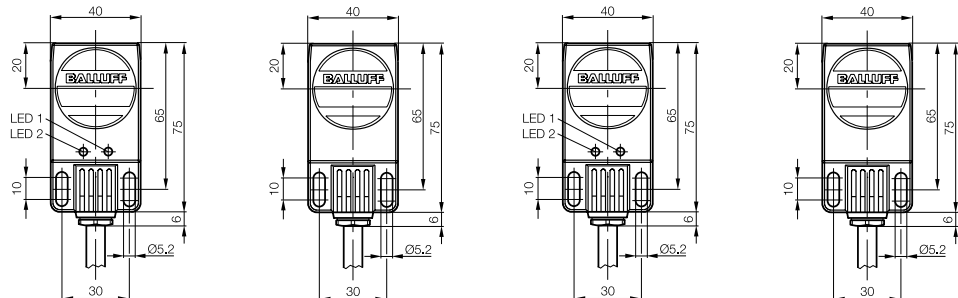

Select between versions **A** or **C**  
 Version A: sensing surface, front  
 Version B: sensing surface, side

# Inductive Couplers

## Unidirectional, power for up to eight sensors



Connection for max. 8 sensors			
<b>M30x1.5</b>	<b>M30x1.5</b>	<b>90x90x45 mm</b>	<b>90x90x45 mm</b>
<b>5 mm</b>		<b>4...12 mm</b>	
Not flush	Not flush	Not flush	Not flush
<b>BIC0045</b>		<b>BIC0023</b>	
BIC 2I3-P2A15-M30MI2-BPX0B-050		BIC 2I3-P2A30-Q90AA-GPX0B-050	
	<b>BIC0048</b>		<b>BIC0028</b>
	BIC 1I3-P2A15-M30MM3-BPX0B-050		BIC 1I3-P2A30-Q90AA-GPX0B-050
	<b>BIC006A</b>		
	BIC 1I3-N1A15-M30MM3-BPX0B-050		
	24 V DC ±10%		24 V DC ±5%
	≤ 1 A		≤ 1.5 A
	≤ 400 mA		≤ 800 mA
	≤ 50 mA		≤ 50 mA
	Yes		Yes
12 ±1.5 V DC		24 ±1.5 V DC	
≤ 150 mA		≤ 300 mA	
75 V DC		75 V DC	
	20 ms		20 ms
0...+50 °C	0...+50 °C	0...+50 °C	0...+50 °C
-25...+75 °C	-25...+75 °C	-25...+75 °C	-25...+75 °C
±3 mm		±6 mm	
	60 Hz		60 Hz
	Yes/No		Yes/Yes
40 Nm	40 Nm		
IP 67	IP 67	IP 67	IP 67
Nickel-plated CuZn	Nickel-plated CuZn	Al	Al
ABS/PBT	PA 12	ABS/PBT	ABS/PBT
PUR cable	PUR cable	PUR cable	PUR cable
9x0.18 mm <sup>2</sup> + 2x0.5 mm <sup>2</sup>	9x0.18 mm <sup>2</sup> + 2x0.5 mm <sup>2</sup>	9x0.18 mm <sup>2</sup> + 2x0.5 mm <sup>2</sup>	9x0.18 mm <sup>2</sup> + 2x0.5 mm <sup>2</sup>



Inductive Couplers  
 Overview  
 Applications  
 Programmable cams  
 Detectors  
 Couplers for detectors  
**Unidirectional**  
 Bidirectional  
 Radial system type  
 Analog, unidirectional  
 Single thermal  
 Terminal boxes  
 Power and signals  
 Power only  
 Uni-Standard and IO-Link  
 IO-Link, unidirectional  
 Topology  
 Connectors

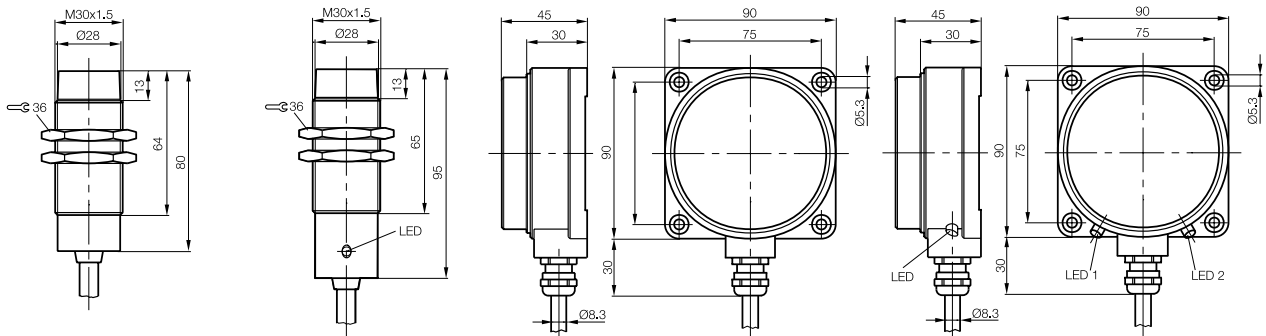

# Inductive Couplers

## Bidirectional

### Four sensor signals and four actuator signals

BIC bidirectional is the coupler system for four sensor signals and four actuator control signals.

The bidirectional system transmits signals inductively in both directions. The remote unit can now be used for controlling individual sensors and clamping units.

From the stationary side base, up to four signals can be transmitted, and four channels can be independently controlled.



Size	
Working range	
Installation	
Remote PNP	<b>Ordering code</b>
5 m cable	Part number
Base PNP	<b>Ordering code</b>
5 m cable	Part number
Supply voltage $U_B$ including residual ripple	
Rated operating current $I_o$	
No-load supply current $I_o$ max.	
Max. current load per output	
Short-circuit protected	
Output voltage	
Power supply, continuous output current	
Rated insulation voltage $U_i$	
Operational readiness	
Ambient temperature $T_a$	
Storage temperature	
Offset	
Switching frequency $f$	
Function/power-on indicator	
Degree of protection as per IEC 60529	
Housing material	
Material of sensing face	
Connection	
Number of conductors × conductor cross-section	

We ask that you request the user's guide for your electrical project planning.



# Inductive Couplers

## Bidirectional

Four sensor signals and four actuator signals

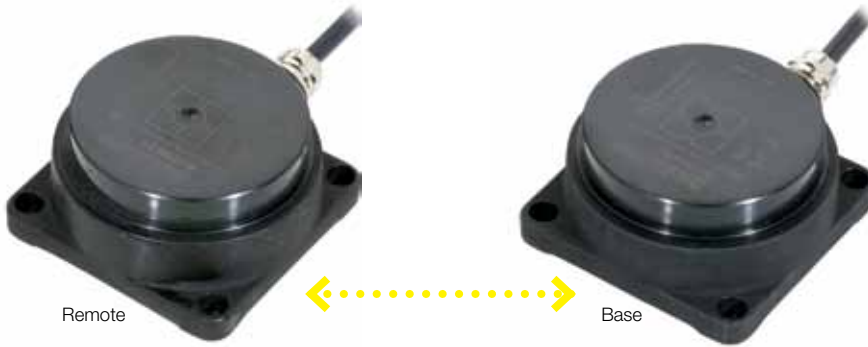

Connection for max. 4 sensors + 4 actuators	
<b>90x90x45 mm</b>	<b>90x90x45 mm</b>
<b>3...10 mm</b>	
Not flush	Not flush
<b>BIC0039</b>	
BIC 2B2-P2A30-Q90AQ-GPX0B-050	
	<b>BIC003C</b>
	BIC 1B2-P2A30-Q90AQ-GPX0B-050
	24 V DC ±10%
	≤ 1.5 A
	≤ 800 mA
	≤ 50 mA
	Yes
24 ±1.5 V DC	
≤ 300 mA	
75 V DC	
0...+50 °C	30 ms
-25...+75 °C	0...+50 °C
±7 mm	-25...+75 °C
	40 Hz
	Yes/Yes
IP 67	IP 67
Al	Al
ABS/PBT	ABS/PBT
PUR cable	PUR cable
9x0.18 mm <sup>2</sup> + 2x0.5 mm <sup>2</sup>	9x0.18 mm <sup>2</sup> + 2x0.5 mm <sup>2</sup>



Inductive Couplers  
 Overview  
 Applications  
 Programmable cams  
 Detectors  
 Couplers for detectors  
 Unidirectional  
**Bidirectional**  
 Radial system type  
 Analog, unidirectional  
 Single thermal  
 Terminal boxes  
 Power and signals  
 Power only  
 Uni-Standard and IO-Link  
 IO-Link, unidirectional  
 Topology  
 Connectors

The remote is attached on the moving side where the sensors and actuators are located.

The base is connected to the power supply and the controller on the stationary side.

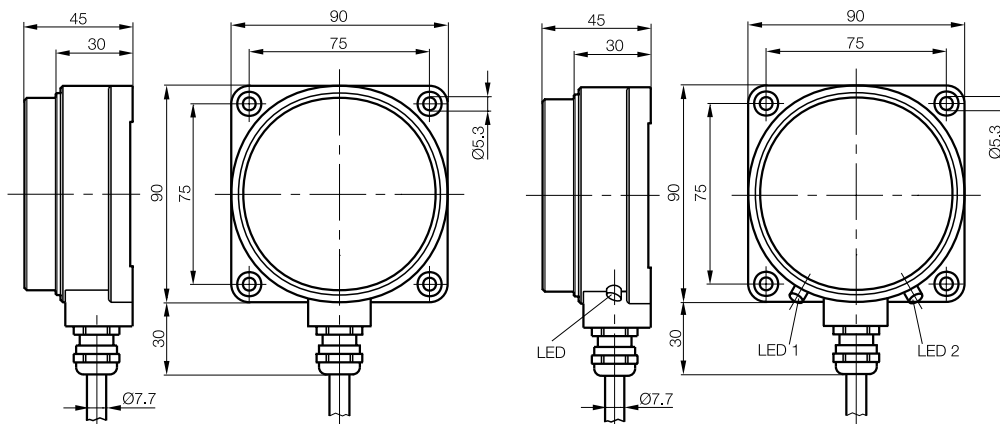

# Inductive Couplers

## Radial system for up to eight sensors

### No slip rings necessary

The modularly designed radial BIC system enables contactless transmission of signals and power during rotation. The switching states of up to 8 digital sensors can be transmitted to a stationary base from rotating shafts, axes and tables. Transmission is always reliable even under the hardest conditions, regardless of speed. Radial BIC systems do not require any service or maintenance work since there is no mechanical contact.

- Intelligent, compact and interference-free
- Contactless, making it wear-free
- Connection for up to 8 sensors
- Power supply for sensors already integrated
- Plug-and-Play: plug in, switch on and evaluate data



Size	
Working range	
Installation	
Remote PNP	<b>Ordering code</b>
	Part number
Base PNP	<b>Ordering code</b>
	Part number
Supply voltage $U_B$ , including residual ripple	
Rated operating current $I_o$	
No-load supply current $I_o$ max.	
Max. current load per output	
Short-circuit protected	
Output voltage	
Power supply, continuous output current	
Rated insulation voltage $U_i$	
Operational readiness	
Ambient temperature $T_a$	
Storage temperature	
Offset	
Switching frequency $f$	
Function/power-on indicator	
Degree of protection as per IEC 60529	
Housing material	
Material of sensing face	
Connection	
Recommended connector	
Weight	

Sensor with cable

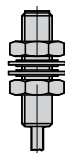

Plug connector  
User-fabricated with connection thread  
See brochure "The Accessories Line"

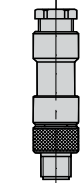

BKS-S 82-00

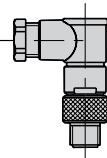

BKS-S 91-00

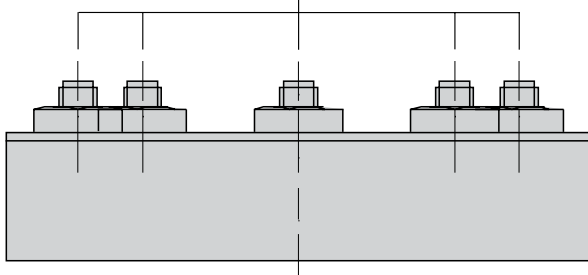

We ask that you request the user's guide for your electrical project planning.

### Plug connector

#### BCC014K

BKS-S 96-PU-05

#### BCC014M

BKS-S 97-PU-05

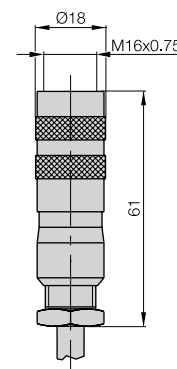
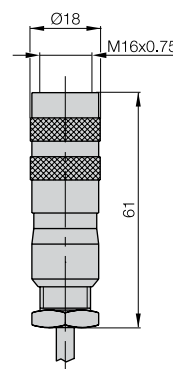

# Inductive Couplers

## Radial system for up to eight sensors



Remote



Base



### Connection for 8 sensors

<b>Ø 93</b>	<b>93x83x45 mm</b>
<b>2 mm</b> on shaft Ø 45 mm	stationary
<b>BIC003P</b> BIC 2I3-P2A16-R01K01-SM3A30	
	<b>BIC003N</b> BIC 1I3-P2A16-R01K01-C03
	24 V DC ±5%
	≤ 700 mA
	≤ 700 mA
	≤ 30 mA
Yes	Yes
24 V DC	
≤ 160 mA	
75 V DC	
0...+70 °C	2 ms
-25...+75 °C	0...+70 °C
±1 mm	-25...+75 °C
	1000 Hz
	Yes/Yes
IP 67	IP 67
PETP	PETP
PETP	PETP
Plug connector	Plug connector
BKS-S 82-00/BKS-S 91-00	1× BKS-S 96 and 1× BKS-S 97
755 g	340 g

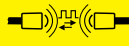

Inductive Couplers  
Overview  
Applications  
Programmable cams  
Detectors  
Couplers for detectors  
Unidirectional  
Bidirectional  
**Radial system type**  
Analog, unidirectional  
Single thermal  
Terminal boxes  
Power and signals  
Power only  
Uni-Standard and IO-Link  
IO-Link, unidirectional  
Topology  
Plug connector

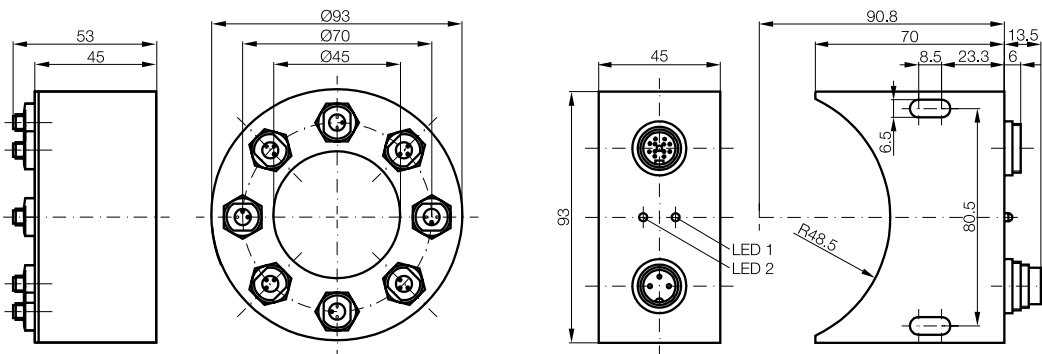

**Recommended accessories:**  
(please order separately)

Description	Ordering code
Cover cap	<b>BAM0113</b>



### Set ordering:

BAV BP-PP-00014-01 **Set00W2**

Set contains: 1× BIC003N Base  
1× BCC014K BKS-S96  
1× BCC014M BKS-S97

You can find special accessories for photoelectric sensors, such as **reflectors, apertures, lenses, filters and deflection heads**, in our **Object Detection** catalog.

**More mechanical accessories:** You can find a large selection of mounting components of all types, such as clamping holders, mounting brackets and the Balluff mounting system BMS, in our **Accessory Product Line** catalog.

# Inductive Couplers

## Radial system for up to four analog signals 0...10 V DC

### Non-contact inductive energy and analog signal transmission for applications where cables are not permitted

Transmitting sensor signals from rotating machine parts or change tools and transmitting power are often a difficult task for design engineers.

This is because, in addition to a reliable connection with high availability, establishing a connection for transmitting power and data is frequently required. Conventional solution approaches are usually based on solutions prone to contact and wear, such as slip rings or mechanical connectors.

The radial BIC system from Balluff is the contactless and wear-free alternative. Thanks to the radial and axial coupling options, it opens up entirely new possibilities for users to transmit up to 4 independent analog signals.

The generously allotted supply of power ensures contactless signal transfer of inductive distance sensors BAW or magneto-inductive displacement sensors BIL and other analog systems. This allows even the transducer series BTL with an analog output to be connected without restriction.



Size	
Working range	
Installation	
Remote PNP	<b>Ordering code</b>
	Part number
Base PNP	<b>Ordering code</b>
	Part number
Supply voltage $U_B$ including residual ripple	
Rated operating current $I_o$	
No-load supply current $I_o$ max.	
Load resistance $R_L$ (per output)	
Resolution	
Measuring range	Output voltage
	Output voltage
Short-circuit protected	
Output voltage	
Power supply, continuous output current	
Rated insulation voltage $U_i$	
Operational readiness	
Ambient temperature $T_a$	
Storage temperature	
Offset	
Switching frequency $f$	
Function/power-on indicator	
Degree of protection as per IEC 60529	
Housing material	
Material of sensing face	
Connection	
Recommended connector	
Weight	

We ask that you request the user's guide for your electrical project planning.

### Plug connector BKS-S 82-00 or BKS-S 91-00

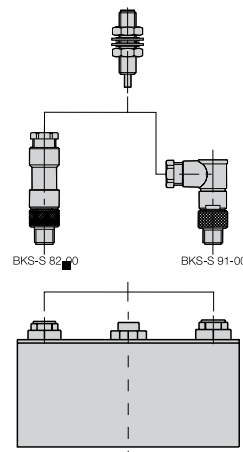

### Plug connector BCC M415-000... and BKS-S115

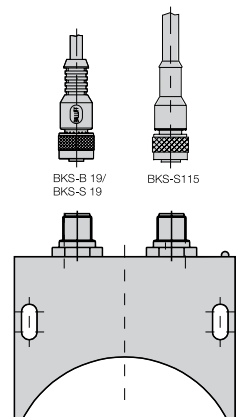

# Inductive Couplers

## Radial system for up to four analog signals 0...10 V DC



Connection for 4 analog sensors	
<b>Ø 93</b>	<b>93x70x45 mm</b>
<b>2 mm</b> on shaft Ø 45 mm	stationary
<b>BIC004A</b> BIC 2I2-V1A18-R01K01-SM3A30	
	<b>BIC0049</b> BIC 1I2-V1A18-R01K01-C01
	24 V DC ±5%
	≤ 800 mA
	≤ 250 mA
	1 kΩ
12 bit	12 bit
4x0...10.65 V DC	4x0...10.65 V DC
Yes	Yes
24 V DC	
≤ 180 mA	
75 V DC	
0...+70 °C	≤ 10 ms
-25...+75 °C	0...+70 °C
±1 mm	-25...+75 °C
	±1 mm
	250 Hz/channel
	Yes/Yes
IP 67	IP 67
PETP	PETP
PETP	PETP
Plug connector	Plug connector
BKS-S 82-00/BKS-S 91-00	1x BKS-B 19-1-PU-__ and 1x BKS-S115-PU-__
650 g	250 g



Inductive Couplers  
 Overview  
 Applications  
 Programmable cams  
 Detectors  
 Couplers for detectors  
 Unidirectional  
 Bidirectional  
**Radial system type**  
 Analog, unidirectional  
 Single thermal  
 Terminal boxes  
 Power and signals  
 Power only  
 Uni-Standard and IO-Link  
 IO-Link, unidirectional  
 Topology  
 Connectors

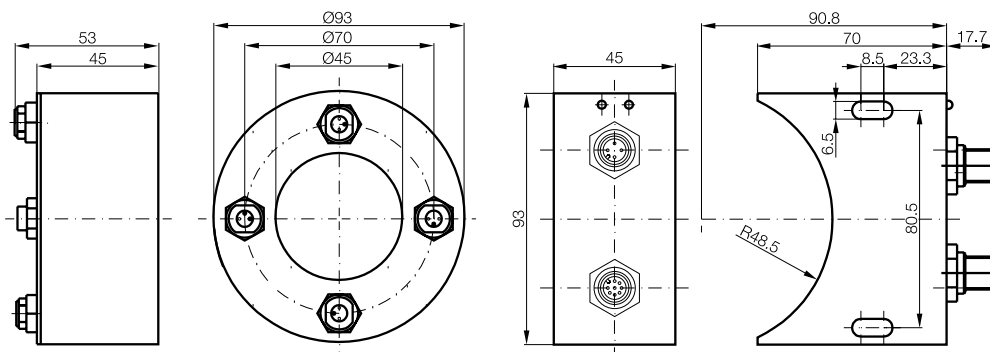

**Recommended accessories:**  
 (please order separately)

Description	Ordering code
Cover cap	<b>BAM0113</b>



You can find special accessories for photoelectric sensors, such as **reflectors, apertures, lenses, filters and deflection heads**, in our **Object Detection** catalog.

# Inductive Couplers

## For one analog displacement sensor 0...10 V DC

### Remote – detect moving components

Digital signals are not the only signal that can be transmitted inductively, now analog signals can be processed as well. The power for the analog displacement sensor from the BAW series (voltage output of 0...10 V DC) is provided inductively and, like the sensor's analog output signal, transmitted without contact.

This enables the use of BAW sensors in places such as moving machine tool components. The remote built into a rotating shaft reliably transmits the information to the base regardless of the rotational speed.

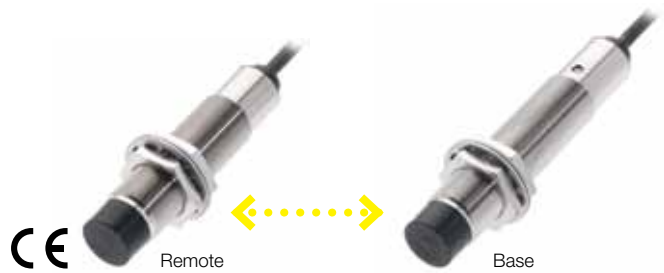

Size	M18x1	M18x1
Working range	2.5 mm	
Installation	Not flush	Not flush
Remote	<b>Ordering code</b>	
5 m cable	Part number	BIC 210-V1A01-M18MI2-BPX03-050
Base	<b>Ordering code</b>	<b>BIC0046</b>
5 m cable	Part number	BIC 110-V1003-M18MN2-BPX03-050
Supply voltage $U_b$ including residual ripple		24 V DC $\pm 5\%$
No-load supply current $I_0$ max.		$\leq 150$ mA
Output signal		0...10 V DC
Short-circuit protected		Yes
Signal input	0...10 V DC	
Load resistance $R_L$	$\geq 2$ k $\Omega$	
max. non-linearity	$\leq \pm 0.8\%$ of $U_a$ max.	
Resolution	$\leq \pm 0.05$ V DC	$\leq 0.1\%$
Temperature drift	$\leq \pm 0.04\%/^{\circ}\text{C}$	
Power supply, continuous output current	$\leq 10$ mA	
Rated insulation voltage $U_i$	75 V DC	
Operational readiness		200 ms
Ambient temperature $T_a$	0...+60 $^{\circ}\text{C}$	0...+60 $^{\circ}\text{C}$
Storage temperature	-25...+75 $^{\circ}\text{C}$	-25...+75 $^{\circ}\text{C}$
Offset	$\pm 2$ mm	
Switching frequency $f$		25 Hz
Function/power-on indicator		Yes/Yes
Tightening torque	40 Nm	40 Nm
Degree of protection as per IEC 60529	IP 67	IP 67
Housing material	Nickel-plated CuZn	Nickel-plated CuZn
Material of sensing face	ABS/PBT	ABS/PBT
Connection	PUR cable	PUR cable
Number of conductors x conductor cross-section	3x0.34 mm <sup>2</sup>	3x0.34 mm <sup>2</sup>

We ask that you request the user's guide for your electrical project planning.

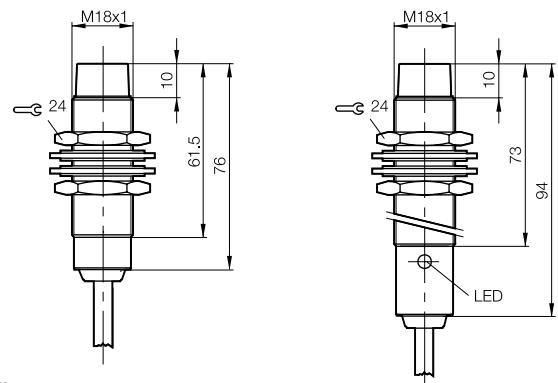

### Examples of compatible inductive distance sensors

Part number	Size	Output signal	Linear range $S_L$
BAW M08EI-UAD15B-	M8 x 1	0...10 V	0.5...1.5 mm
BAW M12MG2-UAC20B-	M12x1	0...10 V	0.5...2.0 mm
BAW M12MF2-UAC40F-	M12x1	0...10 V	1.0...4.0 mm
BAW M18MI-UAC50B-S04G	M18x1	0...10 V	1.0 ... 5.0 mm
BAW M18ME-UAC50B-	M18x1	0...10 V	1.0 ... 5.0 mm
BAW M18MG-UAC80F-S04G	M18x1	0...10 V	2.0...8.0 mm
BAW M30ME-UAC10B-S04G	M30x1.5	0...10 V	2.0 ... 10.0 mm

See Position and Distance Measurement brochure

# Inductive Couplers

## Single thermal

### Remote – non-contact transmission of temperature values

Thermal remote systems are compatible with PT100 thermocouples for sensing temperature on moving components even while they are being processed. The thermocouple detects the temperature of the object and changes its resistance value, which is processed by the remote. The digitized information is passed to the base. The latter converts the digital values into an analog signal (4...20 mA) and provides it to the external controller.



Size	M18x1	M18x1
Working range	1...4 mm	
Installation	Not flush	Not flush
Remote	<b>Ordering code</b>	<b>BIC0041</b>
5 m cable	Part number	BIC 2I0-R1002-M18MF2-BPX03-050
Remote	<b>Ordering code</b>	<b>BIC004C</b>
5 m cable	Part number	BIC 2I0-R3002-M18MF2-BPX03-050
Base	<b>Ordering code</b>	<b>BIC0047</b>
5 m cable	Part number	BIC 1I0-C1A02-M18MN2-BPX03-050
Supply voltage $U_b$ including residual ripple		24 V DC $\pm 5\%$
Rated operating current $I_o$		$\leq 200$ mA
No-load supply current $I_o$ max.		$\leq 150$ mA
Output signal		4...20 mA
Short-circuit protected		Yes
Temperature measuring range	0...+100 °C ( <b>BIC0041</b> ) 0...+300 °C ( <b>BIC004C</b> )	
Load resistance $R_L$		$\leq 400 \Omega$
Measurement deviation		$\leq \pm 0.8\%$ of $I_a$ max.
Delay time	0.5 s	
Temperature drift		$\leq \pm 0.04\%/^{\circ}\text{C}$
Rated insulation voltage $U_i$	75 V DC	
Operational readiness		2 s
Ambient temperature $T_a$	0...+60 °C	0...+60 °C
Storage temperature	-25...+75 °C	-25...+75 °C
Offset	$\pm 2.5$ mm	
Switching frequency $f$		25 Hz
Function/power-on indicator		Yes/Yes
Tightening torque	20 Nm	20 Nm
Degree of protection as per IEC 60529	IP 67	IP 67
Housing material	Nickel-plated CuZn	Nickel-plated CuZn
Material of sensing face	ABS/PBT	ABS/PBT
Connection	PUR cable	PUR cable
Number of conductors x conductor cross-section	3x0.3 mm <sup>2</sup>	3x0.3 mm <sup>2</sup>



Inductive Couplers  
Overview  
Applications  
Programmable cams  
Detectors  
Couplers for detectors  
Unidirectional  
Bidirectional  
Radial system type  
**Analog, unidirectional**  
**Single thermal**  
Terminal boxes  
Power and signals  
Power only  
Uni-Standard and IO-Link  
IO-Link, unidirectional  
Topology  
Connectors

We ask that you request the user's guide for your electrical project planning.

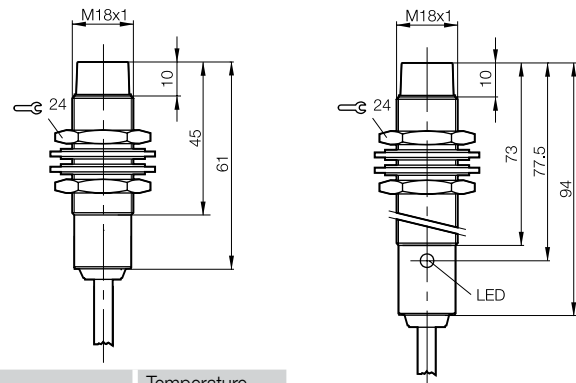

### Remote

Ordering code	Part number	Temperature measuring range
<b>BIC0041</b>	BIC 2I0-R1002-M18MF2-BPX03-050	0...+100 °C
<b>BIC004C</b>	BIC 2I0-R3002-M18MF2-BPX03-050	0...+300 °C

### Compatible PT100 thermocouples

If required, thermocouple with temperature measuring ranges of 0...+100 °C and 0...+300 °C used in conjunction with the corresponding remote.

# Inductive Couplers

## Terminal boxes

Rugged splitter boxes for easily connecting the sensors to the remote with cable outlet.

The remote sensor is connected using a terminal block with spring clamps – no screws required.

The sensors are connected using standard M12 connectors.

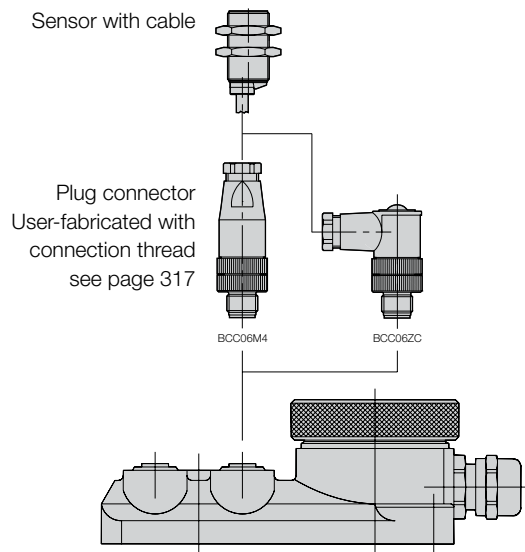

### Distribution list

#### BPI0069

BPI 4M4A40-2M-IC-THF7

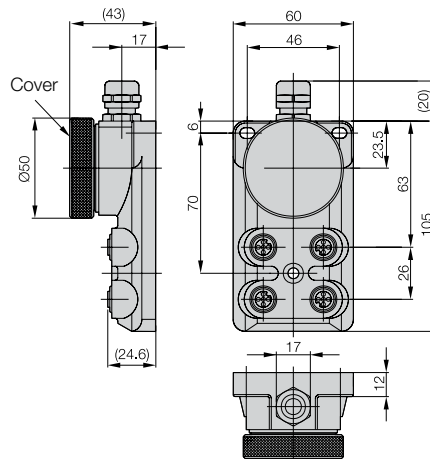

### Distribution list

#### BPI006C

BPI 8M4A40-2M-IC-THFC

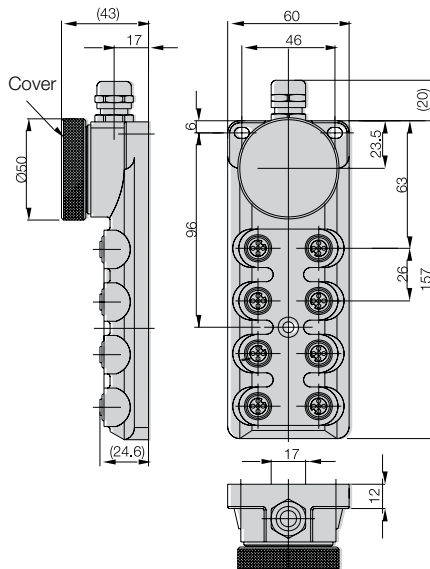



# Inductive Couplers

## Rapid disconnection of power and signals

### For maximum flexibility – Non-contacting power transmission and reliable data transfer

Inductive couplers are at their best whenever modules that route signals have to be able to be disconnected quickly and connected correctly. The ability to disconnect units quickly allows you to implement new requirements with the utmost flexibility in almost no time. Power and signals are transmitted over the air gap reliably, quickly and with exceptional performance.

Retrofitting is simple: BIC is plug-and-play. Your maintenance costs are reduced to a minimum. Cable breaks and mechanical wear are a thing of the past.

The IO-Link connection allows up to 16 sensors per system and lets you connect to the bus environment.

The best solutions for the application can be selected from various performance classes in a compact design.



Simple plug connection with Balluff connectors BCC

IP 67 degree of protection

Function indicators visible from all angles

Large working range of 0...5 mm

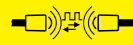

- Inductive Couplers
- Overview
- Applications
- Programmable cams
- Detectors
- Couplers for detectors
- Unidirectional
- Bidirectional
- Radial system type
- Analog, unidirectional
- Single thermal
- Terminal boxes**
- Power and signals**
- Power only
- Uni-Standard and IO-Link
- IO-Link, unidirectional
- Topology
- Connectors

# Inductive Couplers

## Power only

- Simple connection, quick startup
- Wear-free
- Robust, even in harsh environments



Size	
Working range	
Installation	
<b>Ordering code</b>	
Part number	
Supply voltage $U_B$ including residual ripple	
Rated operating current $I_o$	
No-load supply current $I_o$ max.	
Max. current load per output	
Short-circuit protected	
Remote output voltage	
Power supply, continuous output current	
Rated insulation voltage $U_i$	
Operational readiness	
Ambient temperature $T_a$	
Storage temperature	
Offset	
Switching frequency $f$	
Function/power-on indicator	
Tightening torque	
Degree of protection as per IEC 60529	
Housing material	
Material of sensing face	
Connection	

Retrofitting is simple – Plug-and-Play lets you quickly install BIC. Your maintenance costs are reduced to a minimum since cable breaks and mechanical wear become a thing of the past.



# Inductive Couplers

## Power only



Power only with 0.2 A of power		Power only with 0.5 A of power	
<b>M30x1.5</b>	<b>M30x1.5</b>	<b>M30x1.5</b>	<b>M30x1.5</b>
<b>0...5 mm</b>	<b>0...5 mm</b>	<b>0...5 mm</b>	<b>0...5 mm</b>
Not flush	Not flush	Not flush	Not flush
<b>BIC0052</b>	<b>BIC0051</b>	<b>BIC0008</b>	<b>BIC0007</b>
BIC 2P0-P2A20-M30ME1-SM4A5A	BIC 1P0-P2A20-M30ME-SM4A4A	BIC 2P0-P2A50-M30MI3-SM4A5A	BIC 1P0-P2A50-M30MI3-SM4A4A
	24 V DC $\pm 10\%$ max. 500 mA 100 mA		24 V DC $\pm 10\%$ max. 1 A 100 mA
Yes	Yes	Yes	Yes
24 V DC $\pm 5\%$ 200 mA 150 V DC/125 V AC < 1 ms -5...+55 °C -25...+75 °C	150 V DC/125 V AC -5...+55 °C -25...+75 °C	24 V DC $\pm 5\%$ 500 mA 150 V DC/125 V AC < 100 ms 0...+55 °C -25...+75 °C	150 V DC/125 V AC 0...+55 °C -25...+75 °C
$\pm 4$ mm 10 Hz Yes/Yes 70 Nm IP 67 CuZn coated PC	10 Hz Yes/Yes 70 Nm IP 67 CuZn coated PC	$\pm 4$ mm 10 Hz Yes/Yes 70 Nm IP 67 CuZn coated PC	10 Hz Yes/Yes 70 Nm IP 67 CuZn coated PC
M12 connector, female, 5-pin	M12 connector, male, 4-pin	M12 connector, female, 5-pin	M12 connector, male, 4-pin



Inductive Couplers  
Overview  
Applications  
Programmable cams  
Detectors  
Couplers for detectors  
Unidirectional  
Bidirectional  
Radial system type  
Analog, unidirectional  
Single thermal  
Terminal boxes  
Power and signals  
**Power only**  
Uni-Standard  
IO-Link, unidirectional  
Topology  
Connectors

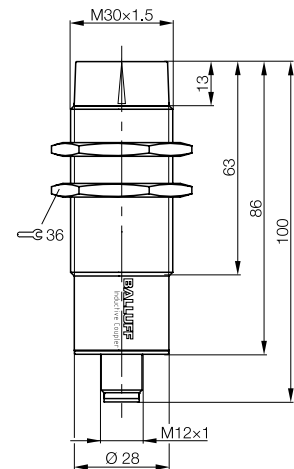
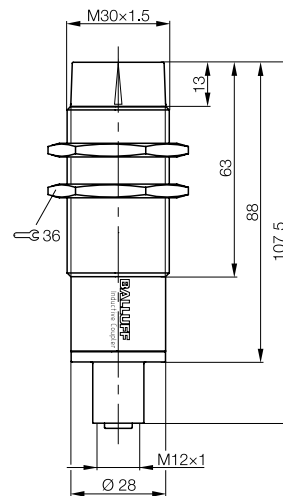
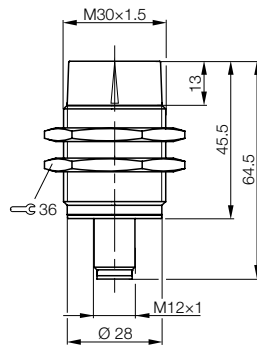
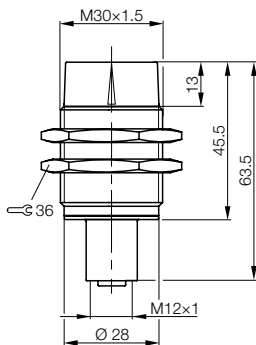

You can find more information  
on inductive couplers BIC online at  
[www.balluff.com](http://www.balluff.com)

# Inductive Couplers

## Uni-Standard and IO-Link

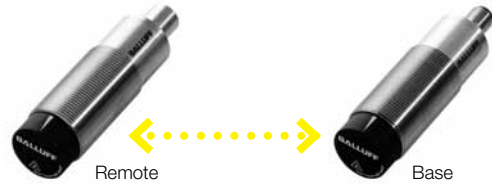

### Uni-standard with 0.5 A power and 8 signals

	<b>M30x1.5</b>	<b>M30x1.5</b>
Size	<b>0...5 mm</b>	<b>0...5 mm</b>
Working range	Not flush	Not flush
Installation	<b>BIC000A</b>	<b>BIC0009</b>
<b>Ordering code</b>	<b>BIC000A</b>	<b>BIC0009</b>
Part number	BIC 2I3-P2A50-M30MI3-SM4ACA	BIC 1I3-P2A50-M30MI3-SM4ACA
Supply voltage $U_B$ , including residual ripple		24 V DC $\pm 10\%$
Rated operating current $I_o$		max. 1 A
No-load supply current $I_o$ max.		100 mA
Max. current load per output		50 mA
Short-circuit protected	Yes	Yes
Remote output voltage	24 V DC $\pm 5\%$	
Power supply, continuous output current	500 mA	
Rated insulation voltage $U_i$	150 V DC/125 V AC	150 V DC/125 V AC
Operational readiness	< 100 ms	
Ambient temperature $T_a$	0...+55 °C	0...+55 °C
Storage temperature	-25...+75 °C	-25...+75 °C
Offset	$\pm 4$ mm	
Switching frequency $f$	40 Hz	40 Hz
Function/power-on indicator	Yes/Yes	Yes/Yes
Tightening torque	70 Nm	70 Nm
Degree of protection as per IEC 60529	IP 67	IP 67
Housing material	CuZn coated	CuZn coated
Material of sensing face	PC	PC
Connection	M12 connector, female, 12-pin	M12 connector, male, 12-pin



### IO-Link

Transfer rate		
Cycle time min.		
Process data cycle		
IO-Link process data length		
Frame type		

### Additional advantages

- Simple wiring of rotary index tables, interchangeable stamping heads, etc.
- Plug-in connection for M12
- Control of capacitive loads
- More power in the same design

### Robot gripper

The sensor determines whether the gripper has collected the workpiece. The switching state of the sensors is transmitted without contact.

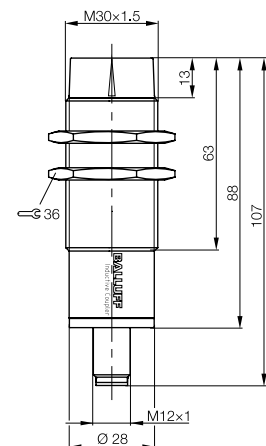
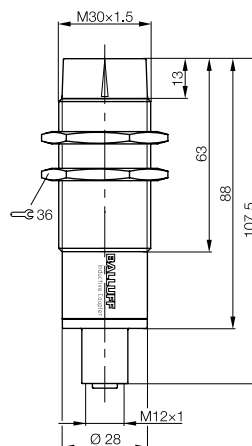
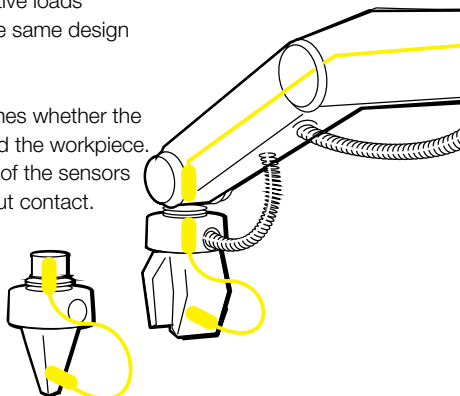

Together with sensor hub

Together with analog hub

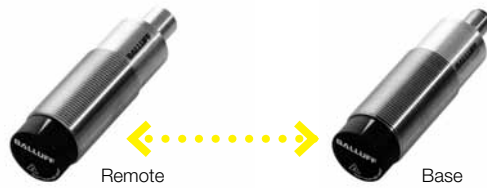
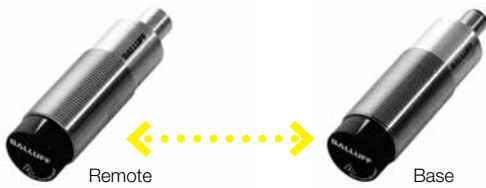

IO-Link interface 16 IN		IO-Link interface 4x, analog	
<b>M30x1.5</b>	<b>M30x1.5</b>	<b>M30x1.5</b>	<b>M30x1.5</b>
<b>0...5 mm</b>	<b>0...5 mm</b>	<b>0...5 mm</b>	<b>0...5 mm</b>
Not flush	Not flush	Not flush	Not flush
<b>BIC000E</b>	<b>BIC000C</b>	<b>BIC0054</b>	<b>BIC0053</b>
BIC 210-I2A50-M30MI3-SM4A5A	BIC 110-I2A50-M30MI3-SM4A4A	BIC 210-IAA50-M30MI3-SM4A5A	BIC 110-IAA50-M30MI3-SM4A4A
	24 V DC ±10% max. 1 A		24 V DC ±10% max. 1 A
Yes	Yes	Yes	Yes
24 V DC ±5% 500 mA 150 V DC/125 V AC < 100 ms 0...+55 °C -25...+75 °C	150 V DC/125 V AC 0...+55 °C -25...+75 °C	24 V DC ±5% 500 mA 150 V DC/125 V AC < 100 ms 0...+55 °C -25...+75 °C	150 V DC/125 V AC 0...+55 °C -25...+75 °C
±4 mm IO-Link*	IO-Link*	±4 mm IO-Link*	IO-Link*
Yes/Yes 70 Nm IP 67 CuZn coated PC	Yes/Yes 70 Nm IP 67 CuZn coated PC	Yes/Yes 70 Nm IP 67 CuZn coated PC	Yes/Yes 70 Nm IP 67 CuZn coated PC
M12 connector, female, 5-pin	M12 connector, male, 4-pin	M12 connector, female, 5-pin	M12 connector, male, 4-pin
38.4 kbaud 3 ms 12 ms 3 input bytes 1	38.4 kbaud 3 ms 12 ms 3 input bytes 1	38.4 kbaud 3 ms 33 ms 11 input bytes 1	38.4 kbaud 3 ms 33 ms 11 input bytes 1



- Inductive Couplers
- Overview
- Applications
- Programmable cams
- Detectors
- Couplers for detectors
- Unidirectional
- Bidirectional
- Radial system type
- Analog, unidirectional
- Single thermal
- Terminal boxes
- Power and signals
- Power only
- Uni-Standard and IO-Link**
- IO-Link, unidirectional
- Topology
- Connectors

Take advantage of the IO-Link connection, which allows up to 16 sensors per system and lets you connect to the fieldbus environment.

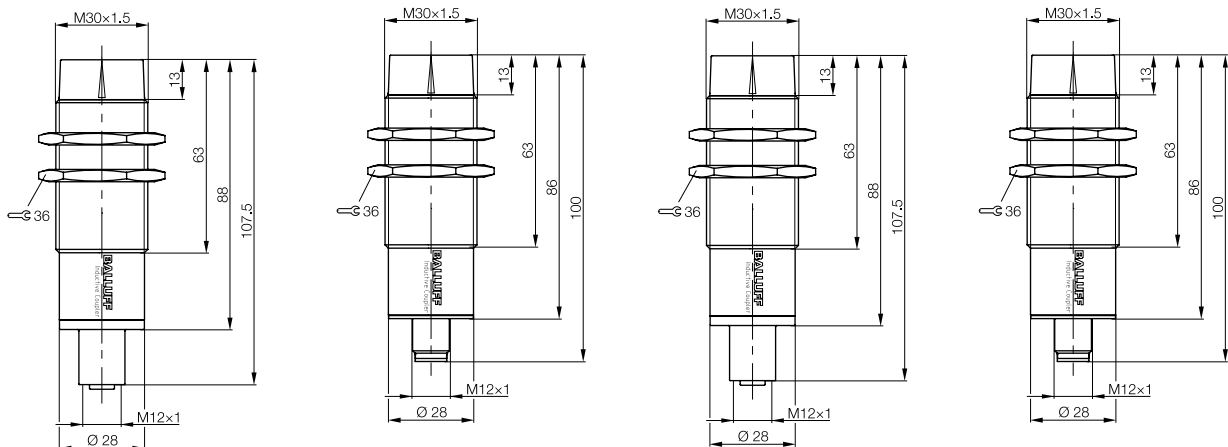

# Inductive Couplers

## IO-Link unidirectional in 40x40 mm Unicompat housing

### IO-Link unidirectional in 40x40 mm Unicompat housing

The IO-Link interface guarantees simple installation IO-Link can be wired quickly and the new housing concept also reduces interfering variables.

Inductive couplers make mechanical plug-in contacts unnecessary because the signals can be reliably transmitted without contact via an air gap. This ensures freedom from wear, rapid format changes and great flexibility. This makes IO-Link unidirectional in the compact 40x40 housing ideal for robotics coupling.

- No mechanical wear
- Maintenance-free
- Increased system availability
- Fast replacement of change tools
- Simple system design
- Quick wiring for tools

### Gripper change in robotics





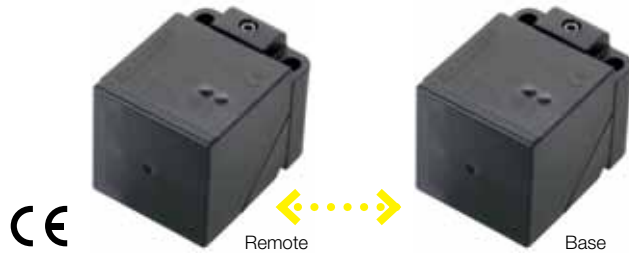

	IO-Link	
	40x40x63 mm	40x40x63 mm
Size	40x40x63 mm	40x40x63 mm
Working range	1 mm...5 mm	1 mm...5 mm
<b>Ordering code</b>	<b>BIC005C</b>	<b>BIC005A</b>
Part number	BIC 210-I2A50-Q40KFU-SM4A5A	BIC 110-I2A50-Q40KFU-SM4A4A
Supply voltage $U_b$ including residual ripple		24 V DC $\pm 10\%$
Rated operating current $I_o$		1000 mA
No-load supply current $I_o$ max.		100 mA
Max. current load per output	800 mA	
Short-circuit protected	Yes	Yes
Remote output voltage	24 V DC $\pm 5\%$	
Power supply, continuous output current	500 mA	
Operational readiness	< 100 ms	
Ambient temperature $T_a$	-5...+55 °C	-5...+55 °C
Storage temperature	-25...+70 °C	-25...+70 °C
Transmission distance	0...5 mm	0...5 mm
Function/power-on indicator	Yes/Yes	Yes/Yes
Weight	Approx. 160 g	Approx. 160 g
Degree of protection as per IEC 60529	IP 67	IP 67
Housing material	PBTP	PBTP
Material of sensing face	PBTP	PBTP
Connection	M12 connector, female, 5-pin, A-coded	M12 connector, male, 4-pin, A-coded

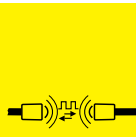

Inductive Couplers  
 Overview  
 Applications  
 Programmable cams  
 Detectors  
 Couplers for detectors  
 Unidirectional  
 Bidirectional  
 Radial system type  
 Analog, unidirectional  
 Single thermal  
 Terminal boxes  
 Power and signals  
 Power only  
 Uni-Standard and IO-Link  
**IO-Link, unidirectional**  
 Topology  
 Connectors

IO-Link		
Transfer rate	38.4 kbaud	38.4 kbaud
Cycle time min.	3 ms	3 ms
Process data cycle		12 ms at minimum cycle time
IO-Link process data length	3 input bytes	3 input bytes
Frame type	1	1

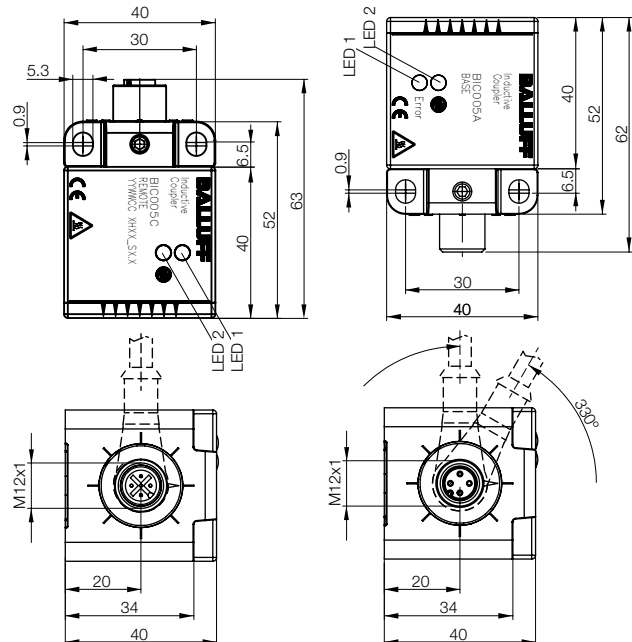

# Inductive Couplers Topology

## Power only inductive coupler BIC – 0.5 A of power

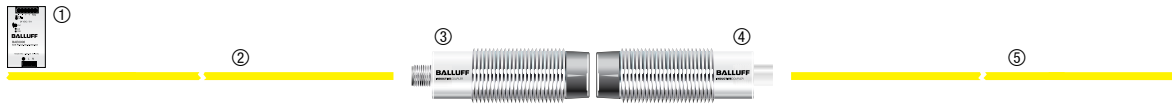

- ① Power supplies BAE
- ② Connection cable BCC
- ③ Inductive coupler BIC – Base
- ④ Inductive coupler BIC – Remote
- ⑤ Connection cable BCC

## Uni-Standard inductive coupler BIC – 0.5 A power and 8 signals

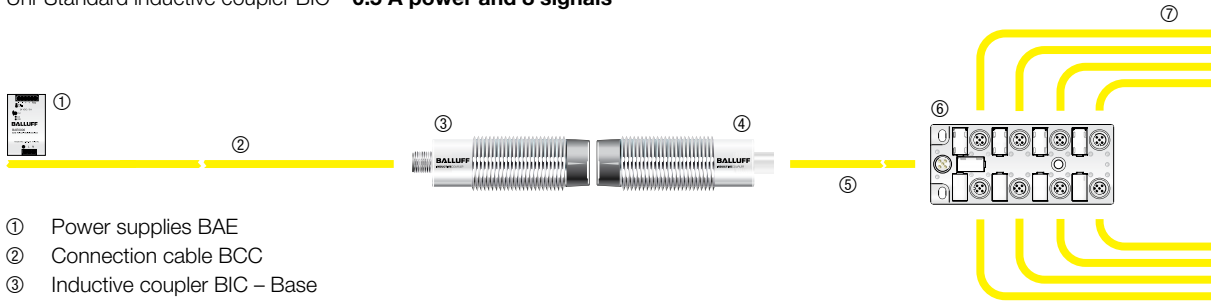

- ① Power supplies BAE
- ② Connection cable BCC
- ③ Inductive coupler BIC – Base
- ④ Inductive coupler BIC – Remote
- ⑤ Connection cable BCC
- ⑥ M12 passive splitter boxes BPI or
- ⑦ Sensor connection

## Inductive coupler BIC – IO-Linkconnection, 0.5 A power and 8 or 16 signals (depending on the sensor hub)

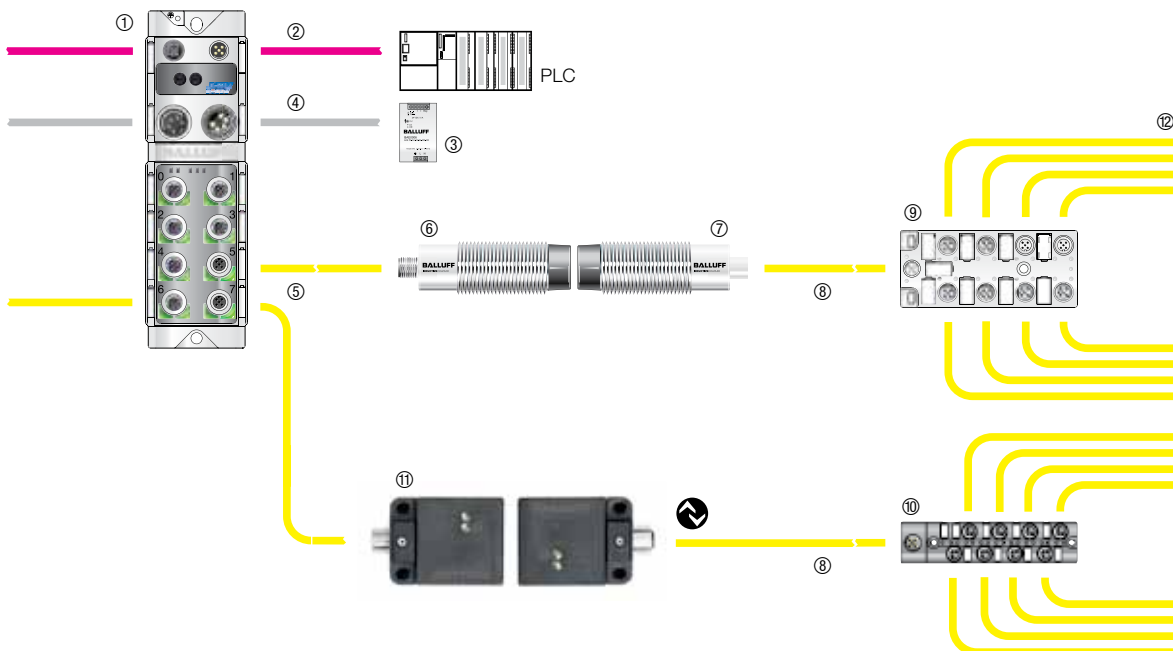

- ① IO-Link master BNI
- ② Bus connection
- ③ Power supplies BAE
- ④ 7/8" power cable BCC
- ⑤ Connection cable BCC
- ⑥ Inductive coupler BIC – Base
- ⑦ Inductive coupler BIC – Remote
- ⑧ Connection cable BCC
- ⑨ M12 sensor hub BNI or M8 sensor hub BNI
- ⑩ IO-Link unidirectional in 40x40 mm Unicompact housing
- ⑪ Sensor connection
- ⑫ Sensor connection











# Inductive Couplers

## M12 female straight connector, 12-pin

## M12 male straight connector, 12-pin



View of female/ Plug side		<ul style="list-style-type: none"> <li>1 ————— BN</li> <li>2 ————— BU</li> <li>3 ————— WH</li> <li>4 ————— GN</li> <li>5 ————— PK</li> <li>6 ————— YE</li> <li>7 ————— BK</li> <li>8 ————— GY</li> <li>9 ————— RD</li> <li>10 ——— VT</li> <li>11 ——— GY/PK</li> <li>12 ——— RD/BU</li> </ul>		<ul style="list-style-type: none"> <li>1 ————— BN</li> <li>2 ————— BU</li> <li>3 ————— WH</li> <li>4 ————— GN</li> <li>5 ————— PK</li> <li>6 ————— YE</li> <li>7 ————— BK</li> <li>8 ————— GY</li> <li>9 ————— RD</li> <li>10 ——— VT</li> <li>11 ——— GY/PK</li> <li>12 ——— RD/BU</li> </ul>
Max. supply voltage AC $U_B$	30 V DC	30 V DC	30 V DC	
Max. supply voltage DC $U_B$	30 V DC	30 V DC	30 V DC	
Cable	Molded	Molded	Molded	
Number of conductors × conductor cross-section	12×0.25 mm <sup>2</sup>	12×0.25 mm <sup>2</sup>	12×0.25 mm <sup>2</sup>	
Degree of protection as per IEC 60529	IP 68	IP 68	IP 68	
Ambient temperature $T_a$	PUR	–40...+90 °C/–25...+90 °C (UL 80 °C)	–40...+90 °C/–25...+90 °C (UL 80 °C)	
Static/moving	PVC	–40...+105 °C/–5...+105 °C (UL 80 °C)	–40...+105 °C/–5...+105 °C (UL 80 °C)	
Use	BIC0009 Base	BIC0009 Base	BIC000A Remote	

Cable material	Color	Length	Ordering code		
			Part number		
PUR		Black	2 m	<b>BCC06UK</b>	<b>BCC06UU</b>
				BCC M41C-0000-1A-049-PX0C25-020	BCC M41C-0000-2A-049-PX0C25-020
PUR		Black	5 m	<b>BCC06UL</b>	<b>BCC06UW</b>
				BCC M41C-0000-1A-049-PX0C25-050	BCC M41C-0000-2A-049-PX0C25-050
PUR		Black	10 m	<b>BCC06UM</b>	<b>BCC06UY</b>
				BCC M41C-0000-1A-049-PX0C25-100	BCC M41C-0000-2A-049-PX0C25-100
PVC		Gray	2 m	<b>BCC06UP</b>	<b>BCC06UZ</b>
				BCC M41C-0000-1A-049-VX8C25-020	BCC M41C-0000-2A-049-VX8C25-020
PVC		Gray	5 m	<b>BCC06UR</b>	<b>BCC06W0</b>
				BCC M41C-0000-1A-049-VX8C25-050	BCC M41C-0000-2A-049-VX8C25-050
PVC		Gray	10 m	<b>BCC06UT</b>	<b>BCC06W1</b>
				BCC M41C-0000-1A-049-VX8C25-100	BCC M41C-0000-2A-049-VX8C25-100

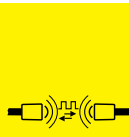

Inductive Couplers  
Overview  
Applications  
Programmable cams  
Detectors  
Couplers for detectors  
Unidirectional  
Bidirectional  
Radial system type  
Analog, unidirectional  
Single thermal  
Terminal boxes  
Power and signals  
Power only  
Uni-Standard and IO-Link  
IO-Link, unidirectional  
**Topology Connectors**

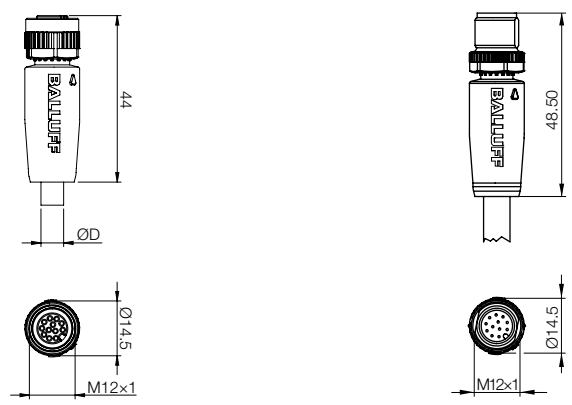

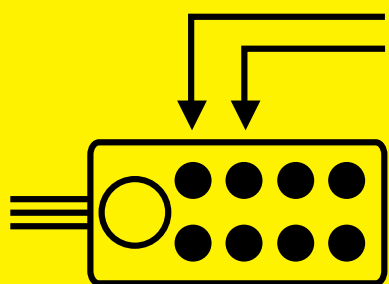

# Passive Splitters



Product topology			242
Passive splitters	M8	3-pin, 4-pin	244
	M12	4-pin, 5-pin	246
Passive interface splitters	M12	4-pin	250
	M12	5-pin	252
Connectors	M12	8-pin, 12-pin	254
	M23	12-pin, 19 pin	256
Accessories			258

## Passive Splitters



Balluff passive interface BPI units connect sensors and actuators to the controller. They are especially ideal for harsh conditions and come highly recommended for situations where coolants and lubricants are used. Metal screw inserts ensure optimum media resistance. A fully enclosed housing provides a higher enclosure rating as well as better shock and vibration resistance characteristics.

Through excellent design, Balluff passive interface BPI units can be integrated into all systems and machines. Metal screw inserts also ensure improved fit of the connectors.

The BPI can be flexibly mounted on all standard profiles and base plates and the mounting bore holes are centrally positioned. Additional mounting bore holes allow you to mount the BPI on its side. Flexible mounting is supported by the highly visible LED.

The full line of Balluff products includes all styles.

### **Balluff BPI passive interface – a multi-talent, even under demanding conditions**

- Outstanding design
- Fully potted housing
- High shock and vibration ratings
- Metal screw inserts
- Flexible mounting options

# Passive Splitters

## Product topology

### Passive splitters

Lightweight and compact M8 and M12 plastic splitter boxes are used wherever space is limited or moving machine members are present. The plastic splitters come either complete or in modular form.

### Features

- Customized, versatile and light, usable as M8 or M12 splitters
- Quick assembly and disassembly for transport
- Potential isolation using jumpers

### Typical applications for the plastic version

- Assembly and handling machines
- Packaging technology
- Specialty machine construction

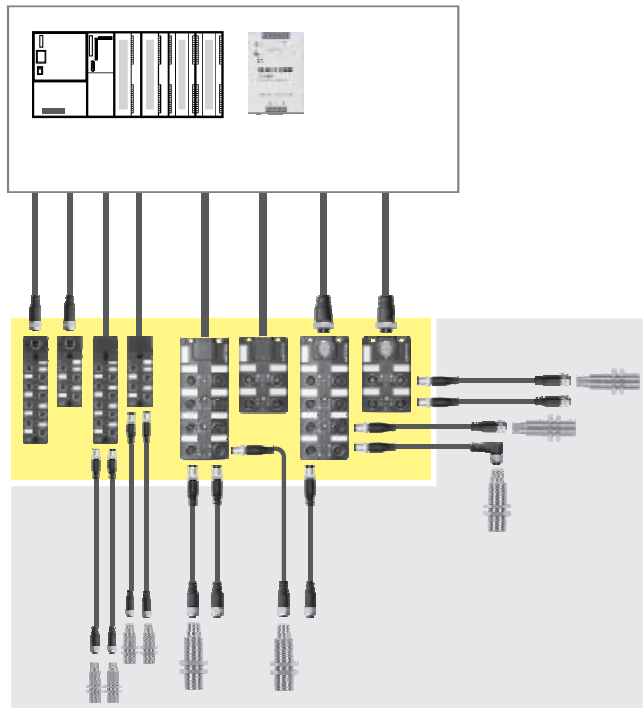

Conventional splitter boxes or wiring directly in the switching cabinet

Use of passive splitter boxes

### Assembly time



Machines, systems and connectivity components are divided into transportable sections and dismantled prior to delivery.

**During commissioning, installation times are normally reduced by 60%.**

### Info/Feedback



LEDs indicate the status of the system.

**Fewer qualified employees are required.**

### Dimension

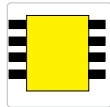

**Usually smaller sizes.**

### Connection technology

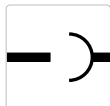
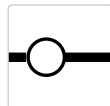

**The plug-in solution provides clear advantages.**

### Complexity

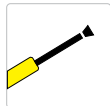

Connectors, sensors and other actuators are easy to replace.

**Downtimes are reduced.**

### Service personnel

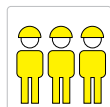

**Fewer qualified employees are required to maintain the machine.**



**You can significantly reduce your installation and maintenance costs with Balluff splitters.**

## Passive Splitters

### M8, 3-pin, with M12 plug connection, LED



View of female/ Plug side		
Version	4-way	8-way
Rated power supply $U_e$	24 V DC	24 V DC
Supply voltage $U_B$	10...30 V DC	10...30 V DC
Function indicator	Yes	Yes
Power-on indicator	Green LED	Green LED
Sensor connection	3-pin female, M8x1	3-pin female, M8x1
Controller connection	M12 connector	M12 connector
Number of connections	4	8
Current load capacity	2 A	2 A
Total current	6 A	6 A
Housing material	PBT, GF	PBT, GF
Degree of protection as per IEC 60529	IP 67 (when screwed into place)	IP 67 (when screwed into place)
Ambient temperature $T_a$	-5...+60 °C	-5...+60 °C
Use	PNP normally open (NO)	PNP normally open (NO)
Recommended connector - port	BCC M313...	BCC M313...
M12 plug connection	BCC M418...	BCC M41C...



Passive splitters  
**Product topology**  
**Passive splitters M8**  
 Passive splitters M12  
 Connectors M12  
 Connectors M23  
 Accessories

<b>Ordering code</b>	
Part number	
<b>BPI003P</b>	<b>BPI003T</b>
BPI 4M303P-2K-00-SM48T	BPI 8M303P-2K-00-SM4CT

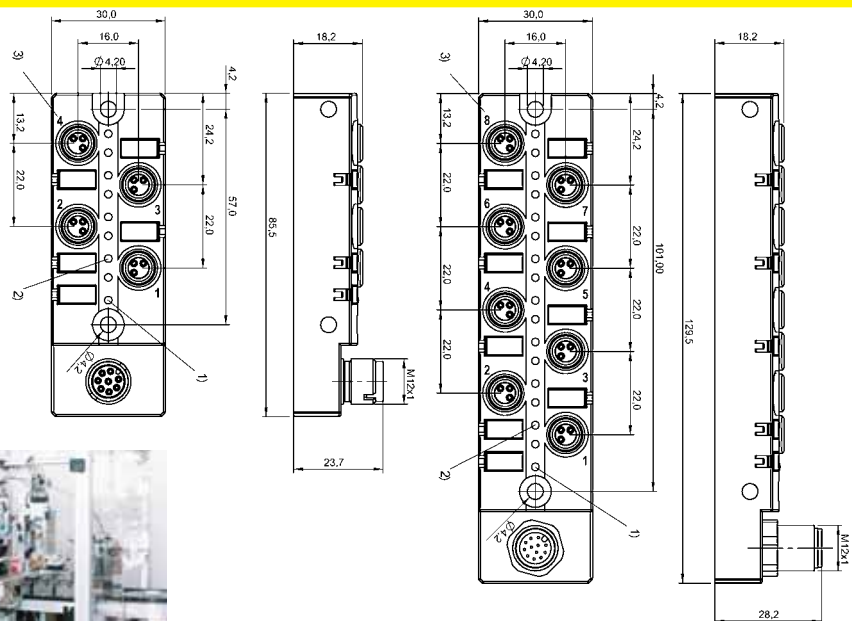



View of female/ Plug side		
Version	4-way	8-way
Rated power supply $U_e$	24 V DC	24 V DC
Supply voltage $U_b$	10...30 V DC	10...30 V DC
Function indicator	Yes	Yes
Power-on indicator	Green LED	Green LED
Sensor connection	3-pin female, M8×1	3-pin female, M8×1
Controller connection	Permanently connected cable	Permanently connected cable
Number of connections	4	8
Current load capacity	2 A	2 A
Total current	6 A	6 A
Housing material	PBT, GF	PBT, GF
Degree of protection as per IEC 60529	IP 67 (when screwed into place)	IP 67 (when screwed into place)
Ambient temperature $T_a$	-5...+60 °C	-5...+60 °C
Use	PNP normally open (NO)	PNP normally open (NO)
Recommended connector - port	BCC M313...	BCC M313...

Cable material	Color	Length	Ordering code	
			Part number	
PUR	Black	3 m	<b>BPI002N</b>	<b>BPI0030</b>
			BPI 4M303P-2K-00-KPX60-030	BPI 8M303P-2K-00-KPXA0-030
PUR	Black	5 m	<b>BPI002P</b>	<b>BPI0031</b>
			BPI 4M303P-2K-00-KPX60-050	BPI 8M303P-2K-00-KPXA0-050
PUR	Black	10 m	<b>BPI002R</b>	<b>BPI0032</b>
			BPI 4M303P-2K-00-KPX60-100	BPI 8M303P-2K-00-KPXA0-100
PUR	Black	15 m	<b>BPI002T</b>	<b>BPI0033</b>
			BPI 4M303P-2K-00-KPX60-150	BPI 8M303P-2K-00-KPXA0-150

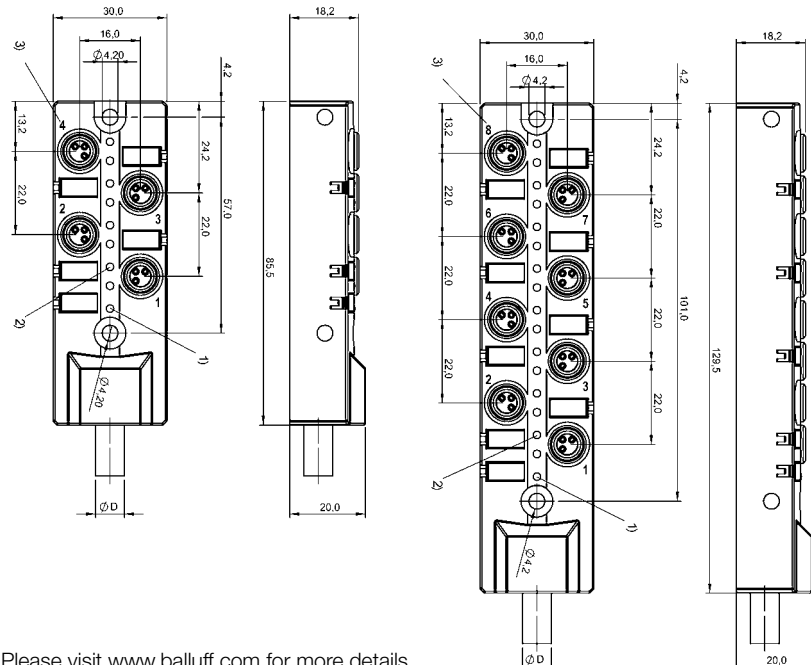

# Passive Splitters

## M8, 4-pin with cable, LED

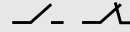
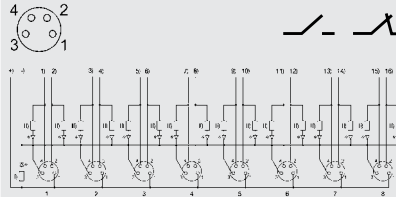
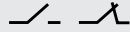
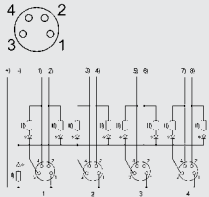

4-way  
24 V DC  
10...30 V DC  
Yes  
Green LED  
4-pin female, M8×1  
Permanently connected cable  
4  
2 A  
6 A  
PBT, GF  
IP 67 (when screwed into place)  
-5...+60 °C  
PNP normally open/normally closed (NO/NC)  $\swarrow$  - /  $\searrow$   
BCC M314...

8-way  
24 V DC  
10...30 V DC  
Yes  
Green LED  
4-pin female, M8×1  
Permanently connected cable  
8  
2 A  
6 A  
PBT, GF  
IP 67 (when screwed into place)  
-5...+60 °C  
PNP normally open/normally closed (NO/NC)  $\swarrow$  - /  $\searrow$   
BCC M314...

### Ordering code

Part number

**BPI0038**  
BPI 4M304P-2K-00-KPXA0-030

**BPI003K**  
BPI 8M304P-2K-00-KPXA0-030

**BPI0039**  
BPI 4M304P-2K-00-KPXA0-050

**BPI003L**  
BPI 8M304P-2K-00-KPXA0-050

**BPI003A**  
BPI 4M304P-2K-00-KPXA0-100

**BPI003M**  
BPI 8M304P-2K-00-KPXA0-100

**BPI003C**  
BPI 4M304P-2K-00-KPXA0-150

**BPI003N**  
BPI 8M304P-2K-00-KPXA0-150

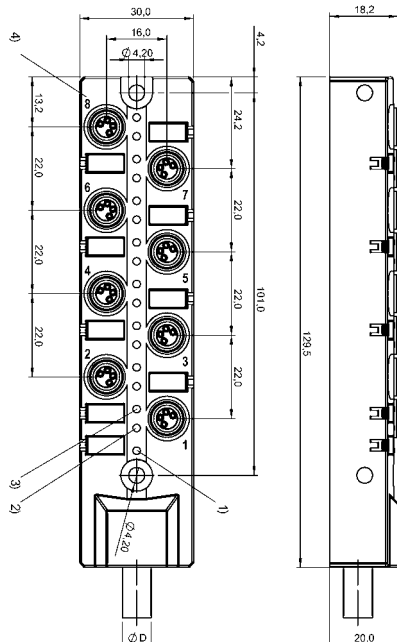
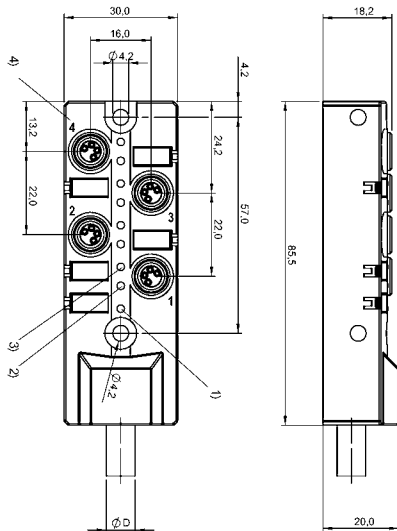

Passive splitters  
Product topology  
**Passive splitters M8**  
Passive splitters M12  
Passive interface splitters M12  
Connectors M12  
Connectors M23  
Accessories



View of female/ Plug side			
Version	8-way		
Rated power supply $U_e$	24 V DC		
Supply voltage $U_b$	10...30 V DC		
Function indicator	Yes		
Power-on indicator	Green LED		
Sensor connection	4-pin female, M12×1		
Controller connection	Permanently connected cable		
Number of connections	8		
Current load capacity	2 A		
Total current	6 A		
Housing material	PBT, GF		
Degree of protection as per IEC 60529	IP 67 (when screwed into place)		
Ambient temperature $T_a$	-5...+60 °C		
Use	PNP normally open (NO) —/—		
Recommended connector - port	BCC M414...		

Cable material	Color	Length	Ordering code	
			Part number	
PUR	Black	3 m	<b>BPI0059</b>	
			BPI 8M4A4P-2K-00-KPXB0-030	
PUR	Black	5 m	<b>BPI005A</b>	
			BPI 8M4A4P-2K-00-KPXB0-050	
PUR	Black	10 m	<b>BPI005C</b>	
			BPI 8M4A4P-2K-00-KPXB0-100	
PUR	Black	15 m	<b>BPI005E</b>	
			BPI 8M4A4P-2K-00-KPXB0-150	

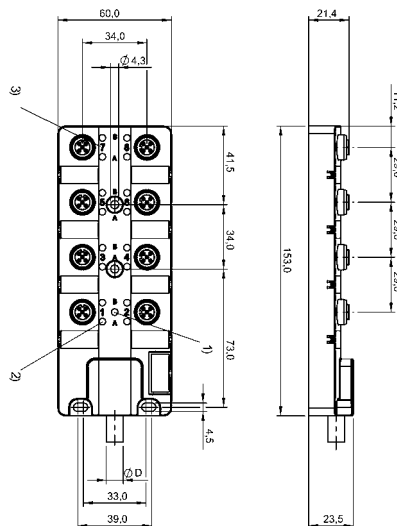



# Passive Splitters

## M12, 5-pin with cable, LED

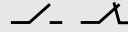
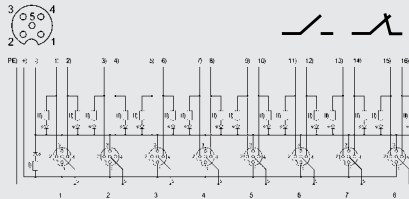
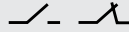
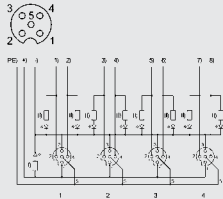

4-way  
24 V DC  
10...30 V DC  
Yes  
Green LED  
5-pin female, M12×1  
Permanently connected cable  
4  
2 A  
6 A  
PBT, GF  
IP 67 (when screwed into place)  
-5...+60 °C  
PNP normally open/normally closed (NO/NC)  $\swarrow$  - /  $\searrow$   
BCC M415...

8-way  
24 V DC  
10...30 V DC  
Yes  
Green LED  
5-pin female, M12×1  
Permanently connected cable  
8  
2 A  
6 A  
PBT, GF  
IP 67 (when screwed into place)  
-5...+60 °C  
PNP normally open/normally closed (NO/NC)  $\swarrow$  - /  $\searrow$   
BCC M415...

### Ordering code

Part number

<b>BPI0049</b> BPI 4M4A5P-2K-00-KPXB0-030	<b>BPI004R</b> BPI 8M4A5P-2K-00-KPXL0-030
<b>BPI004A</b> BPI 4M4A5P-2K-00-KPXB0-050	<b>BPI004T</b> BPI 8M4A5P-2K-00-KPXL0-050
<b>BPI004C</b> BPI 4M4A5P-2K-00-KPXB0-100	<b>BPI004U</b> BPI 8M4A5P-2K-00-KPXL0-100
<b>BPI004E</b> BPI 4M4A5P-2K-00-KPXB0-150	<b>BPI004W</b> BPI 8M4A5P-2K-00-KPXL0-150

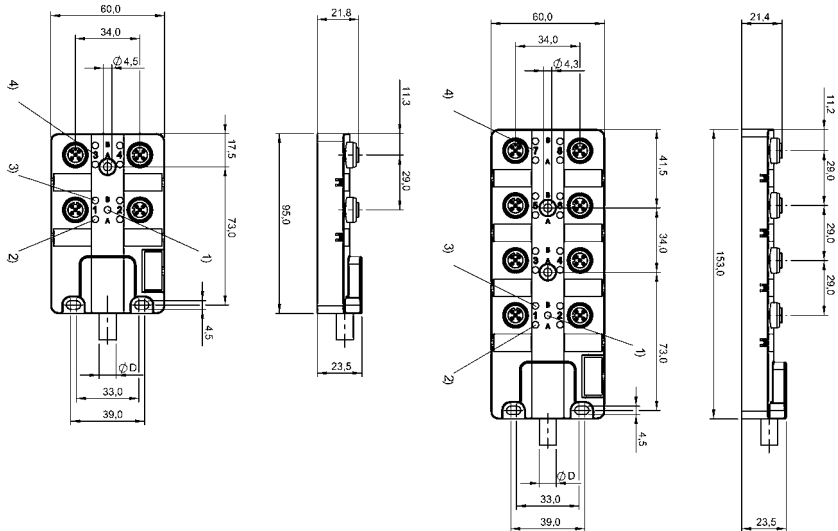

Passive splitters  
Product topology  
Passive splitters M8  
**Passive splitters M12**  
Passive interface splitters M12  
Connectors M12  
Connectors M23  
Accessories



View of female/  
Plug side

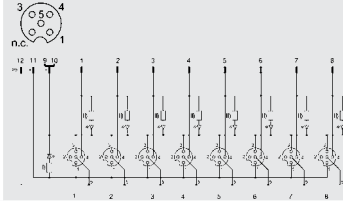
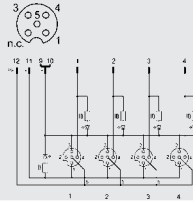

Version	4-way	8-way
Rated power supply $U_e$	24 V DC	24 V DC
Supply voltage $U_b$	10...30 V DC	10...30 V DC
Function indicator	Yes	Yes
Power-on indicator	Green LED	Green LED
Sensor connection	4-pin female, M12×1	4-pin female, M12×1
Controller connection	M23 connector	M23 connector
Number of connections	4	8
Current load capacity	2 A	2 A
Total current	6 A	6 A
Housing material	PBT, GF	PBT, GF
Degree of protection as per IEC 60529	IP 67 (when screwed into place)	IP 67 (when screwed into place)
Ambient temperature $T_a$	-5...+60 °C	-5...+60 °C
Use	PNP normally open (NO) —/—	PNP normally open (NO) —/—
Recommended connector - port	BCCM414	BCCM414
M23 recommended connectors	M23 12-pin BCC M61C..., page 202	M23 12-pin BCC M61C..., page 202

### Ordering code

Part number

**BPI004Y**

BPI 4M4A4P-2K-00-SM6CT

**BPI0050**

BPI 8M4A4P-2K-00-SM6CT

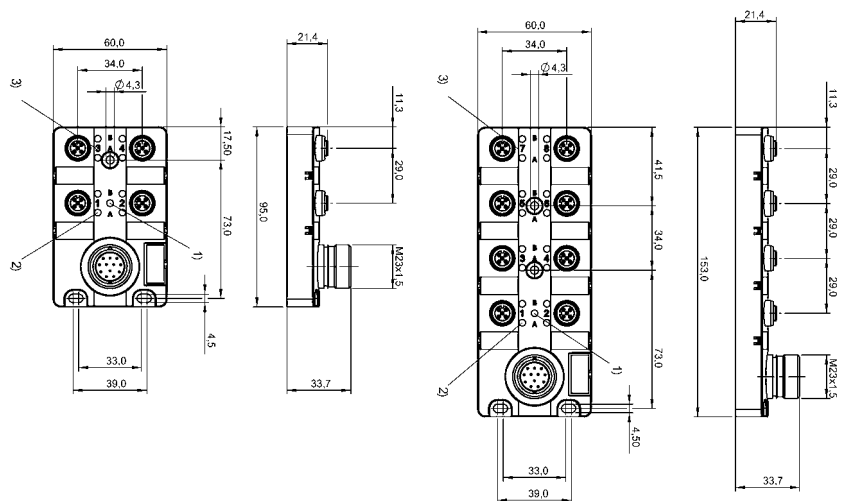

# Passive Splitters

## M12, 5-pin with M23 plug connection, LED

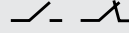
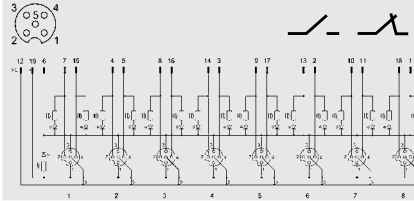
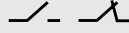
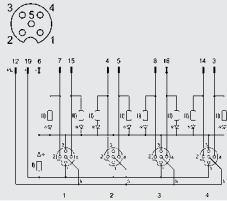

4-way	8-way
24 V DC	24 V DC
10...30 V DC	10...30 V DC
Yes	Yes
Green LED	Green LED
5-pin female, M12×1	5-pin female, M12×1
M23 connector	M23 connector
4	8
2 A	2 A
6 A	6 A
PBT, GF	PBT, GF
IP 67 (when screwed into place)	IP 67 (when screwed into place)
-5...+60 °C	-5...+60 °C
PNP normally open/normally closed (NO/NC)  /	PNP normally open/normally closed (NO/NC)  /
BCCM415	BCCM415
M23 19-pin BCC M61L..., page 203	M23 19-pin BCC M61L..., page 203

### Ordering code

Part number

**BPI004Z**

BPI 4M4A5P-2K-00-SM6LT

**BPI0051**

BPI 8M4A5P-2K-00-SM6LT



Passive splitters  
Product topology  
Passive splitters M8  
**Passive splitters M12**  
Passive interface splitters M12  
Connectors M12  
Connectors M23  
Accessories

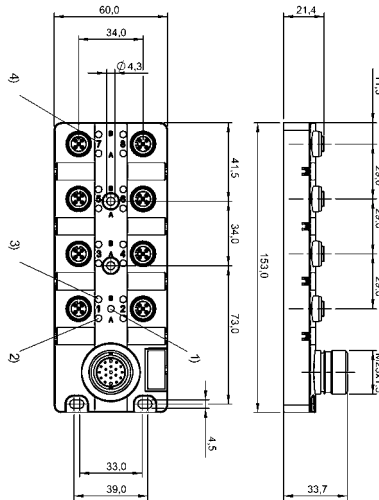
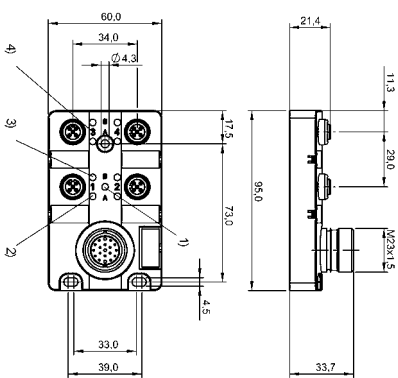

# Passive Splitters

## M12, 4-pin, with cap and cable

### Passive splitters

The passive interface BPI connects sensors and actuators to the controller. It is especially ideal for harsh conditions and comes highly recommended for situations where coolants and lubricants are used. A fully enclosed housing provides a higher enclosure rating as well as better shock and vibration resistance characteristics. Though excellent design, the passive interface BPI can be integrated in all systems and machines. The BPI can be flexibly mounted on all standard profiles and base plates and the mounting bore holes are centrally positioned.

Flexible mounting is supported by highly visible LEDs. Setting up and adjusting your machines and systems is much easier as a result.



Version	4-way, cap with cable	8-way, cap with cable	
Rated power supply $U_e$	24 V DC	24 V DC	
Supply voltage $U_B$	10...30 V DC	10...30 V DC	
Function indicator			
Power-on indicator			
Sensor connection			
Controller connection	Cap connection with cable	Cap connection with cable	
Number of connections			
Current load capacity	2 A	2 A	
Total current	6 A	6 A	
Housing material	PBT, GF	PBT, GF	
Degree of protection as per IEC 60529			
Ambient temperature $T_a$	-25...+80 °C	-25...+80 °C	
Use	for base	for base	
Recommended connector - port			

Cable material	Color	Length	Ordering code	
			Part number	
PUR	Black	3 m	<b>BPI007Z</b> BPI T009-K-00-KPX70-030	<b>BPI0083</b> BPI T00E-K-00-KPXB0-030
PUR	Black	5 m	<b>BPI0080</b> BPI T009-K-00-KPX70-050	<b>BPI0084</b> BPI T00E-K-00-KPXB0-050
PUR	Black	10 m	<b>BPI0081</b> BPI T009-K-00-KPX70-100	<b>BPI0085</b> BPI T00E-K-00-KPXB0-100
PUR	Black	15 m	<b>BPI0082</b> BPI T009-K-00-KPX70-150	<b>BPI0086</b> BPI T00E-K-00-KPXB0-150

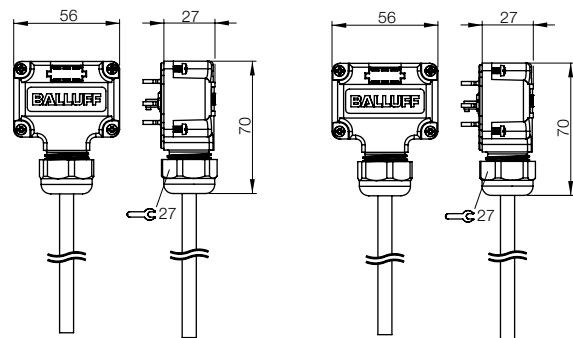

# Passive Splitters

## M12, 4-pin, with cap and cable, LED



4-way, base with LEDs	8-way, base with LEDs	4-way, M12 with LEDs	8-way, M12 with LEDs
24 V DC	24 V DC	24 V DC	24 V DC
10...30 V DC	10...30 V DC	10...30 V DC	10...30 V DC
Yes	Yes	Yes	Yes
Green LED	Green LED	Green LED	Green LED
4-pin female, M12×1	4-pin female, M12×1	4-pin female, M12×1	4-pin female, M12×1
Cap connection with/without cable	Cap connection with/without cable	Cap connection without cable	Cap connection without cable
4	8	4	8
2 A	2 A	2 A	2 A
6 A	6 A	6 A	6 A
PBT, GF, fully potted	PBT, GF, fully potted	PBT, GF, fully potted	PBT, GF, fully potted
IP 67 (when screwed into place)	IP 67 (when screwed into place)	IP 67 (when screwed into place)	IP 67 (when screwed into place)
-25...+80 °C	-25...+80 °C	-25...+80 °C	-25...+80 °C
PNP normally open (NO) ✓/-	PNP normally open (NO) ✓/-	PNP normally open (NO) ✓/-	PNP normally open (NO) ✓/-
BCC M414...	BCC M414...	BCC M414...	BCC M414...

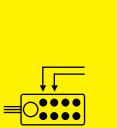

Passive splitters  
Product topology  
Passive splitters M8  
Passive splitters M12  
Passive interface splitters M12  
Connectors M12  
Connectors M23  
Accessories

Ordering code			
Part number			
<b>BPI007A</b>	<b>BPI007E</b>	<b>BPI007L</b>	<b>BPI007J</b>
BPI 4M4A4P-2K-00-TP09	BPI 8M4A4P-2K-00-TP0E	BPI 4M4A4P-2K-00-TPS9	BPI 8M4A4P-2K-00-TPSE

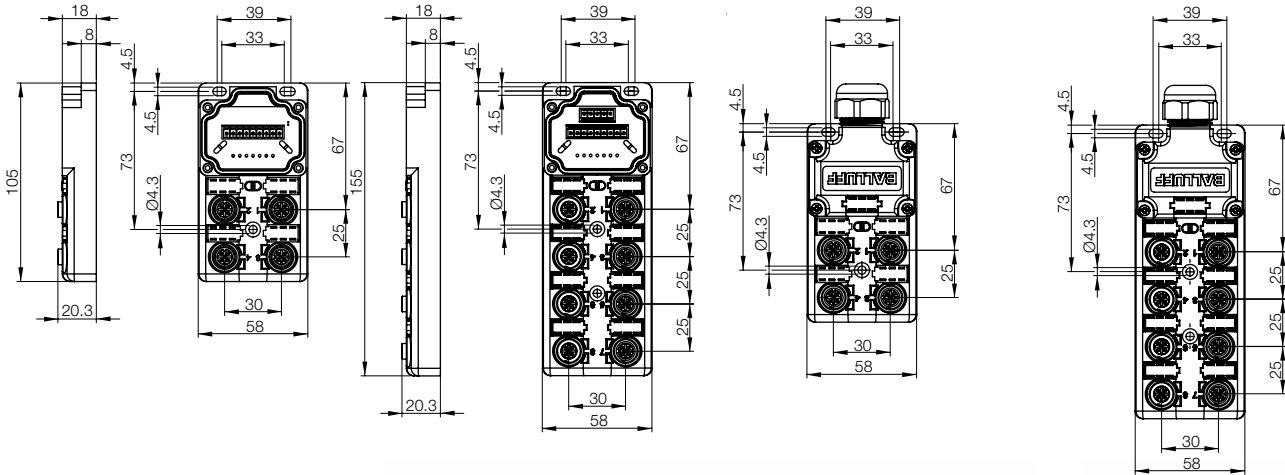

# Passive Splitters

## M12, 5-pin, with cap and cable

### Areas of application

Passive splitter boxes are ideal for use in decentralized assembly and handling machine installations, packaging technology or special purpose machine manufacturing.

### Balluff Passive Interface BPI – A multi-talent, even under demanding conditions

- Outstanding design
- Fully potted housing
- High shock and vibration ratings
- Flexible mounting options
- High visibility of LEDs
- Large terminal compartment
- Modular design
- Quick to mount/detach for transportation



Version	4-way, cap with cable	8-way, cap with cable	
Rated power supply $U_e$	24 V DC	24 V DC	
Supply voltage $U_B$	10...30 V DC	10...30 V DC	
Function indicator			
Power-on indicator			
Sensor connection			
Controller connection	Cap connection with cable	Cap connection with cable	
Number of connections			
Current load capacity	2 A	2 A	
Total current	6 A	6 A	
Housing material	PBT, GF	PBT, GF	
Degree of protection as per IEC 60529			
Ambient temperature $T_a$	-25...+80 °C	-25...+80 °C	
Use	for base	for base	
Recommended connector - port			

Cable material	Color	Length	Ordering code	
			Part number	
PUR	Black	3 m	<b>BPI007M</b> BPI T00G-K-00-KPXB0-030	<b>BPI007T</b> BPI T00N-K-00-KPXL0-030
PUR	Black	5 m	<b>BPI007N</b> BPI T00G-K-00-KPXB0-050	<b>BPI007U</b> BPI T00N-K-00-KPXL0-050
PUR	Black	10 m	<b>BPI007P</b> BPI T00G-K-00-KPXB0-100	<b>BPI007W</b> BPI T00N-K-00-KPXL0-100
PUR	Black	15 m	<b>BPI007R</b> BPI T00G-K-00-KPXB0-150	<b>BPI007Y</b> BPI T00N-K-00-KPXL0-150

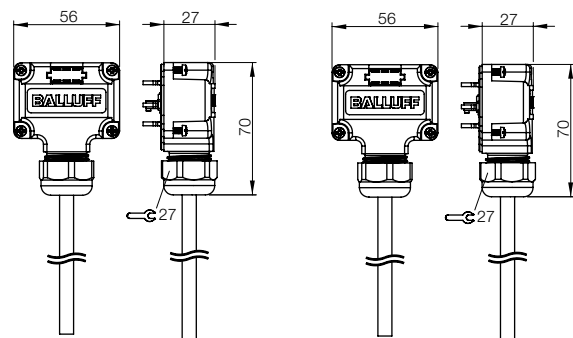

# Passive Splitters

## M12, 5-pin, with cap and cable, LED



4-way, base with LEDs	8-way, base with LEDs	4-way, M12 with LEDs	8-way, M12 with LEDs
24 V DC	24 V DC	24 V DC	24 V DC
10...30 V DC	10...30 V DC	10...30 V DC	10...30 V DC
Yes	Yes	Yes	Yes
Green LED	Green LED	Green LED	Green LED
5-pin female, M12×1	5-pin female, M12×1	5-pin female, M12×1	5-pin female, M12×1
Cap connection with/without cable	Cap connection with/without cable	Cap connection without cable	Cap connection without cable
4	8	4	8
2 A	2 A	2 A	2 A
6 A	6 A	6 A	6 A
PBT, GF, fully potted	PBT, GF, fully potted	PBT, GF, fully potted	PBT, GF, fully potted
IP 67 (when screwed into place)	IP 67 (when screwed into place)	IP 67 (when screwed into place)	IP 67 (when screwed into place)
-25...+80 °C	-25...+80 °C	-25...+80 °C	-25...+80 °C
PNP normally open/normally closed (NO/NC) $\swarrow$ - / $\nearrow$	PNP normally open/normally closed (NO/NC) $\swarrow$ - / $\nearrow$	PNP normally open/normally closed (NO/NC) $\swarrow$ - / $\nearrow$	PNP normally open/normally closed (NO/NC) $\swarrow$ - / $\nearrow$
BCC M415...	BCC M415...	BCC M415...	BCC M415...



Passive splitters  
Product topology  
Passive splitters M8  
Passive splitters M12  
Passive interface splitters M12  
Connectors M12  
Connectors M23  
Accessories

### Ordering code

Part number

#### BPI007C

BPI 4M4A5P-2K-00-TP0G

#### BPI007F

BPI 8M4A5P-2K-00-TP0N

#### BPI007K

BPI 4M4A5P-2K-00-TPSG

#### BPI007H

BPI 8M4A5P-2K-00-TPSN

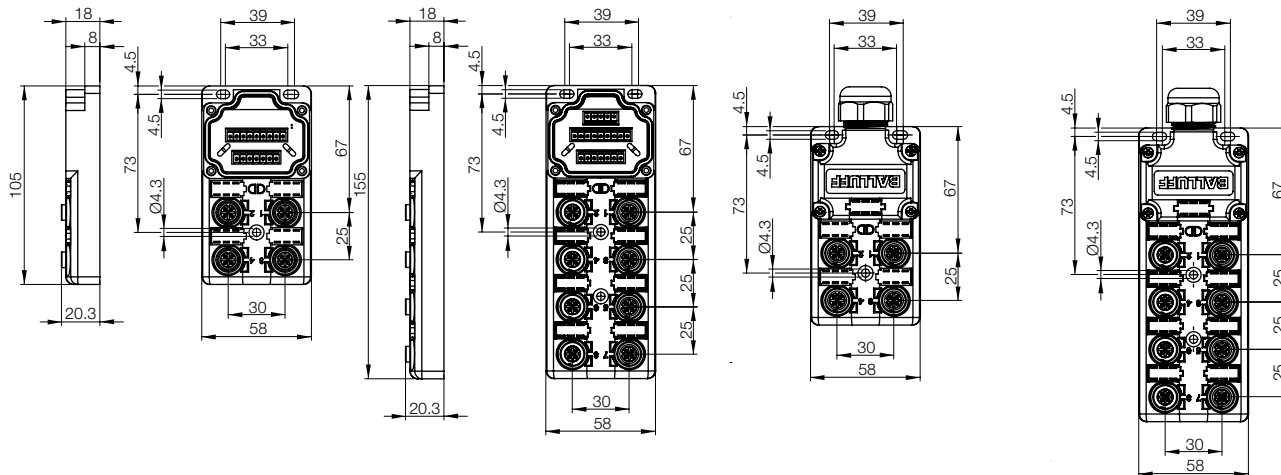







# Passive Splitters

## M12 female straight connector, 8-pin

## M12 female straight connector, 12-pin



Connector diagram and wiring	 <ul style="list-style-type: none"> <li>1 _____ WH</li> <li>2 _____ GN</li> <li>3 _____ YE</li> <li>4 _____ GY</li> <li>5 _____ BN</li> <li>6 _____ PK</li> <li>7 _____ BU</li> <li>8 _____ RD</li> </ul>	 <ul style="list-style-type: none"> <li>1 _____ BN</li> <li>2 _____ BU</li> <li>3 _____ WH</li> <li>4 _____ GN</li> <li>5 _____ PK</li> <li>6 _____ YE</li> <li>7 _____ BK</li> <li>8 _____ GY</li> <li>9 _____ RD</li> <li>10 _____ VT</li> <li>11 _____ GY/PK</li> <li>12 _____ RD/BU</li> </ul>
Max. supply voltage AC $U_B$	60 V DC	60 V DC
Max. supply voltage DC $U_B$	60 V DC	60 V DC
Cable	Molded	Molded
Number of conductors × conductor cross-section	8×0.25 mm <sup>2</sup>	12×0.25 mm <sup>2</sup>
Degree of protection as per IEC 60529	IP 68	IP 68
Ambient temperature $T_a$	PUR -40...+90 °C/-25...+90 °C (UL 80 °C)	-40...+90 °C/-25...+90 °C (UL 80 °C)
Static/moving	PVC -40...+105 °C/-5...+105 °C (UL 80 °C)	-40...+105 °C/-5...+105 °C (UL 80 °C)
Use	BPI, M8, 3-pin, 4-way	BPI, M8, 3-pin, 4-way

Cable material	Color	Length	Ordering code		
PUR		Black	2 m	<b>BCC06K1</b> BCC M418-0000-1A-044-PX0825-020	<b>BCC06UK</b> BCC M41C-0000-1A-049-PX0C25-020
			5 m	<b>BCC06K2</b> BCC M418-0000-1A-044-PX0825-050	<b>BCC06UL</b> BCC M41C-0000-1A-049-PX0C25-050
PUR		Black	10 m	<b>BCC06K3</b> BCC M418-0000-1A-044-PX0825-100	<b>BCC06UM</b> BCC M41C-0000-1A-049-PX0C25-100
PVC		Gray	2 m		<b>BCC06UP</b> BCC M41C-0000-1A-049-VX8C25-020
PVC		Gray	5 m		<b>BCC06UR</b> BCC M41C-0000-1A-049-VX8C25-050
PVC		Gray	10 m		<b>BCC06UT</b> BCC M41C-0000-1A-049-VX8C25-100

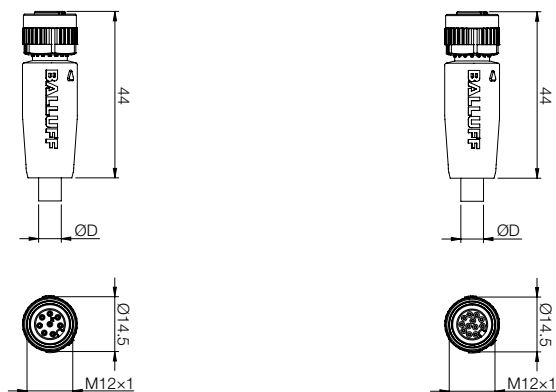







# Passive Splitters

## M12 female straight and right-angle connector, 8-pin, customized assembly



View of female/ Plug side				
Version	Female straight	Female straight	Female right-angle	Female right-angle
Max. supply voltage AC $U_B$	30 V AC	30 V AC	30 V AC	30 V AC
Max. supply voltage DC $U_B$	30 V DC	30 V DC	30 V DC	30 V DC
Cable diameter	4...8 mm	4...8 mm	4...8 mm	4...8 mm
Cable	User-fabricated	User-fabricated	User-fabricated	User-fabricated
Number of conductors × conductor cross-section	8×0.14...0.25 mm <sup>2</sup>	8×0.14...0.25 mm <sup>2</sup>	8×0.14...0.25 mm <sup>2</sup>	8×0.14...0.25 mm <sup>2</sup>
Housing material	CuZn	CuZn	CuZn	CuZn
Degree of protection as per IEC 60529	IP 67	IP 67	IP 67	IP 67
Ambient temperature $T_a$	-25...+85° C	-25...+85° C	-25...+85° C	-25...+85° C
Use	BPI, M8, 3-pin, 8-way, BIC	BPI, M8, 3-pin, 8-way, BIC	BPI, M8, 3-pin, 8-way, BIC	BPI, M8, 3-pin, 8-way, BIC



Passive splitters  
Product topology  
Passive splitters M8  
Passive splitters M12  
Passive interface splitters M12  
**Connectors M12**  
Connectors M23  
Accessories

	<b>Ordering code</b>	
	Part number	
	<b>BCC04MC</b>	<b>BCC04ME</b>
	BCC M478-0000-1A-000-43X834-000	BCC M488-0000-1A-000-43X834-000

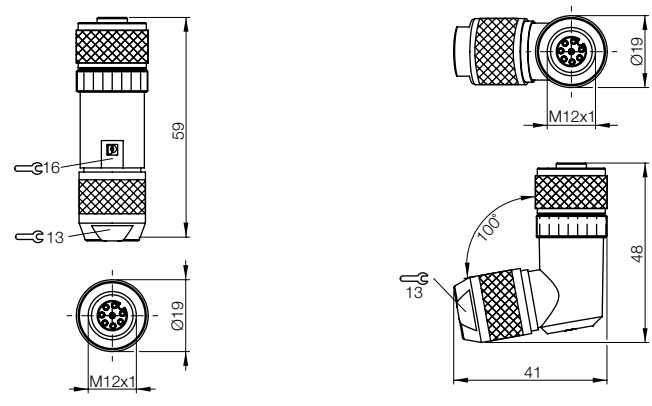

# Passive Splitters

## M23 female connector, straight or right-angle, 12-pin



View of female/ Plug side			
Rated power supply $U_e$	240 V DC	240 V DC	
Supply voltage $U_b$	18...30 V DC	18...30 V DC	
Cable	Permanently molded PUR	Permanently molded PUR	
Number of conductors x conductor cross-section	8x0.50 mm <sup>2</sup> and 3x1.0 mm <sup>2</sup>	8x0.50 mm <sup>2</sup> and 3x1.0 mm <sup>2</sup>	
Housing material	TPU	TPU	
Degree of protection as per IEC 60529	IP 67	IP 67	
Ambient temperature $T_a$	-25...+80° C	-25...+80° C	
Use	BPI, M12, 4-pin, 4/8-way	BPI, M12, 4-pin, 4/8-way	

Cable material	Color	Length	Ordering code	
			Part number	
PUR	Black	2 m	<b>BCC06KN</b>	<b>BCC06KT</b>
			BCC M61C-0000-10-065-PX0BP4-020	BCC M62C-0000-10-065-PX0BP4-020
PUR	Black	5 m	<b>BCC06KP</b>	<b>BCC06KU</b>
			BCC M61C-0000-10-065-PX0BP4-050	BCC M62C-0000-10-065-PX0BP4-050
PUR	Black	10 m	<b>BCC06KR</b>	<b>BCC06KW</b>
			BCC M61C-0000-10-065-PX0BP4-100	BCC M62C-0000-10-065-PX0BP4-100

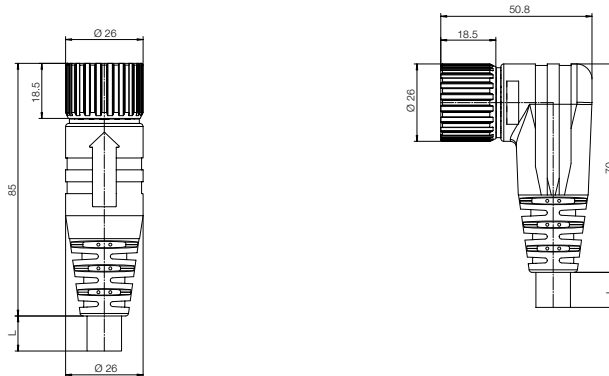

# Passive Splitters

**M23 female connector, straight or right-angle, 19-pin**

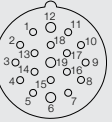
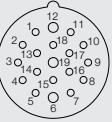

120 V DC	120 V DC
18...30 V DC	18...30 V DC
Permanently molded PUR	Permanently molded PUR
16x0.50 mm <sup>2</sup> and 3x1.0 mm <sup>2</sup>	16x0.50 mm <sup>2</sup> and 3x1.0 mm <sup>2</sup>
TPU	TPU
IP 67	IP 67
-25...+80° C	-25...+80° C
BPI, M12, 5-pin, 4/8-way	BPI, M12, 5-pin, 4/8-way

Ordering code	
Part number	
<b>BCC06KY</b>	<b>BCC06L1</b>
BCC M61L-0000-10-022-PX0LP4-020	BCC M62L-0000-10-022-PX0LP4-020
<b>BCC06KZ</b>	<b>BCC06L2</b>
BCC M61L-0000-10-022-PX0LP4-050	BCC M62L-0000-10-022-PX0LP4-050
<b>BCC06L0</b>	<b>BCC06L3</b>
BCC M61L-0000-10-022-PX0LP4-100	BCC M62L-0000-10-022-PX0LP4-100

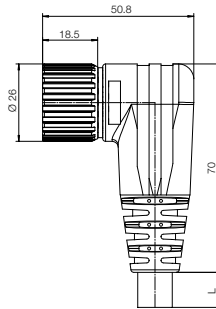
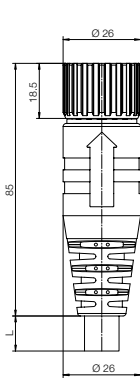

Passive splitters  
 Product topology  
 Passive splitters M8  
 Passive splitters M12  
 Passive interface splitters M12  
 Connectors M12  
**Connectors M23**  
 Accessories

# Passive Splitters

## Accessories



Connector diagram and wiring			
Description	T splitter	Screw plug 7/8"	Screw plug 7/8"
Use	2x M12 female to 1x M12 male	Cover for the power ports	Cover for the power ports
<b>Ordering code</b>	<b>BCC089P</b>	<b>BAM012T</b>	<b>BAM012U</b>
Part number	BCC M415-M415-M415-U0003-000	BKS-7/8-CS-00-A	BKS-7/8-CS-00-I
Supply voltage $U_b$	125 V		
Rated operating current $I_o$	4 A		
Degree of protection as per IEC 60529	IP 67		
Ambient temperature $T_a$	-25...+80 °C	-20...+80 °C	-20...+80 °C
Housing material	PA 6.6 + GF	Nickel-plated CuZn	Nickel-plated CuZn

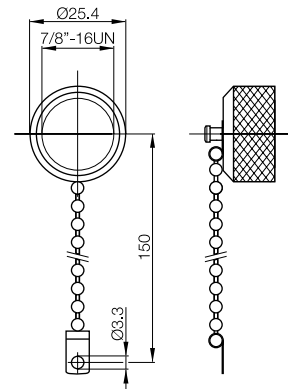
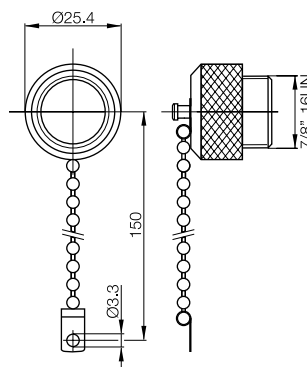
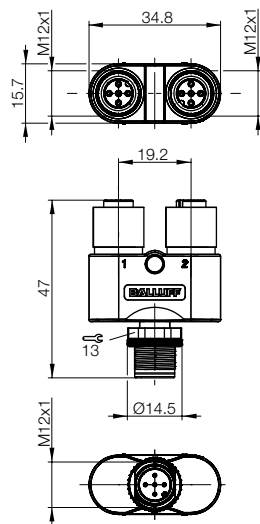

# Passive Splitters Accessories



Description	M8 locking screw	M12 locking screw	Marking sleeve	
Use	IP 65 threaded cover for unused ports	IP 65 threaded cover for unused ports	For labeling connectors	
<b>Ordering code</b>	<b>BAM01C1</b>	<b>BAM01C2</b>		
Part number	BAM CS-XA-001-M8-C	BAM CS-XA-002-M12-A	BAM IA-CC-002-01	
Ambient temperature T <sub>a</sub>	-20...+80 °C	-20...+80 °C		
Housing material	Plastic	Plastic		

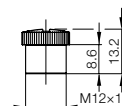
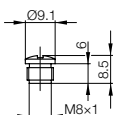

## Assembly wrench

M23 connectors are easy to assemble due to their size. After the components are assembled, the top and bottom section must be secured to one another to guarantee the high degree of protection.



<b>Description</b>	<b>Ordering code</b>
	Part number
Assembly wrench for 12 and 19-pin M23 connectors	<b>BAM01TY</b> BAM TO-CC-002-M6

Refer to the chapter Connectors on for more accessories.



Passive splitters  
Product topology  
Passive splitters M8  
Passive splitters M12  
Passive interface splitters M12  
Connectors M12  
Connectors M23  
**Accessories**

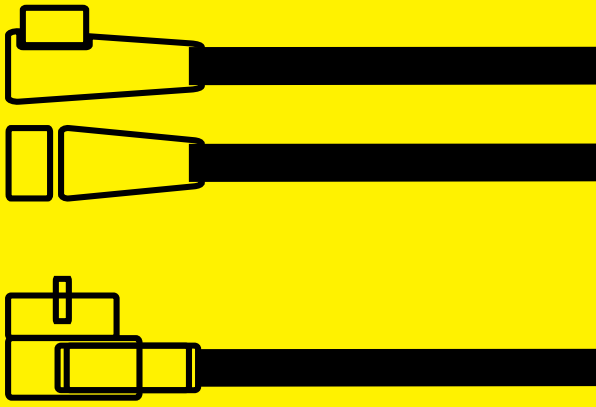

# Connectors and Valve Connectors

Connectors and Valve Connectors



# Connectors and Valve Connectors

## Contents

Breakdown of the BCC part number	262
Dimensions	263
<b>Connectors and cables</b>	
Connectors M5	266
Connection cables M5 ↔ M8	268
Connectors M8	270
Connection cables M8 ↔ M8	274
Connection cables M8 ↔ M12	278
Connectors M12	290
Connection cables M12 ↔ M8	304
Connection cables M12 ↔ M12	308
Tees, adapters	325
Y-connectors M12	326
Accessories	327
Special properties	328
<b>Valve Connectors</b>	348

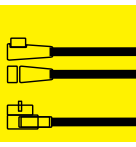

# Connectors and Cables

## Breakdown of the part number BCC

1	2	3	4	5	6	7	8	9	10	11	12	13	14	15	16	17	18	19	20	21	22	23	24	25	26	27	28	29	30	31	32	33	34	35
---	---	---	---	---	---	---	---	---	----	----	----	----	----	----	----	----	----	----	----	----	----	----	----	----	----	----	----	----	----	----	----	----	----	----

**Head 1**                      **Head 2**

B	C	C		M	4	1	4	-	0	0	0	0	-	1	A	-	0	0	8	-	P	X	0	4	3	4	-	0	5	0
---	---	---	--	---	---	---	---	---	---	---	---	---	---	---	---	---	---	---	---	---	---	---	---	---	---	---	---	---	---	---



**Head 1**

5th–8th digit

**Head 1:**

- Design
  - M = Metric
  - V = valve connector
- Size
  - .3 = M8
  - .4 = M12
- Type
  - ..1 = Plastic molded, straight
  - ..2 = Plastic molded, right-angle
  - ..3 = Plastic fabricated, straight
  - ..4 = Plastic fabricated, right-angle
- Number of visible holes or pins
  - ...3 = 3
  - ...4 = 4

10th–13th digit

**Head 2:**

- Design
  - 0 = not assigned
- Size
  - 0 = not assigned
- Type
  - 0 = not assigned
- Number of visible holes or pins
  - 0 = not assigned

15th–16th digit

**Female/male**

- Coding
  - 1 = female
  - 2 = male
- A = A-coded
- B = B-coded
- ...

18th–20th digit

**Wiring**

- 001 = 3 wires without LED
- 004 = 3 wires with LED
- ...

22nd–27th digit

**Cable**

- Cable type
  - P = PUR
  - V = PVC
- Specification
  - .X = Standard
  - .W = Welding
  - .H = Higher temperatures
- Cable color
  - ..0 = Black
  - ..8 = Gray
- Number
  - ...3 = 3-wire
  - ...4 = 4-wire
  - ...5 = 5-wire
- Cross-section
  - ...34 = 0.34 mm<sup>2</sup>
  - ...50 = 0.50 mm<sup>2</sup>
  - ...A1 = 1.50 mm<sup>2</sup>

29th–32nd digit

**Cable length**

- 020 = 2 m
- 100 = 10 m

1	2	3	4	5	6	7	8	9	10	11	12	13	14	15	16	17	18	19	20	21	22	23	24	25	26	27	28	29	30	31	32	33	34	35
---	---	---	---	---	---	---	---	---	----	----	----	----	----	----	----	----	----	----	----	----	----	----	----	----	----	----	----	----	----	----	----	----	----	----

**Head 1**                      **Head 2**

B	C	C		M	4	2	4	-	M	4	1	3	-	3	A	-	3	0	0	-	P	X	0	4	3	4	-	0	2	0
---	---	---	--	---	---	---	---	---	---	---	---	---	---	---	---	---	---	---	---	---	---	---	---	---	---	---	---	---	---	---



**Head 1 + Head 2**

5th–8th digit

**Head 1:**

- Design
  - M = Metric
  - V = valve connector
- Size
  - .3 = M8
  - .4 = M12
- Type
  - ..1 = Plastic molded, straight
  - ..2 = Plastic molded, right-angle
  - ..3 = Plastic fabricated, straight
  - ..4 = Plastic fabricated, right-angle
- Number of visible holes or pins
  - ...3 = 3
  - ...4 = 4

10th–13th digit

**Head 2:**

- Design
  - M = Metric
  - V = valve connector
- Size
  - .3 = M8
  - .4 = M12
- Type
  - ..1 = Plastic molded, straight
  - ..2 = Plastic molded, right-angle
  - ..3 = Plastic fabricated, straight
  - ..4 = Plastic fabricated, right-angle
- Number of visible holes or pins
  - ...3 = 3
  - ...4 = 4

15th–16th digit

**Female/male**

- Coding
  - 3 = female/male
- A = A-coded
- B = B-coded
- 0 = without coding

18th–20th digit

**Wiring**

- 300 = 3 wires without LED
- 600 = 3 wires with LED
- 304 = 4 wires without LED

22nd–27th digit

**Cable**

- Cable type
  - P = PUR
  - V = PVC
- Specification
  - .X = Standard
  - .W = Welding
  - .H = Higher temperatures
- Cable color
  - ..0 = Black
  - ..8 = Gray
- Number
  - ...3 = 3-wire
  - ...4 = 4-wire
  - ...5 = 5-wire
- Cross-section
  - ...34 = 0.34 mm<sup>2</sup>
  - ...50 = 0.50 mm<sup>2</sup>
  - ...A1 = 1.50 mm<sup>2</sup>

29th–32nd digit

**Cable length**

- 006 = 60 cm
- 020 = 2 m

All order numbers illustrated are only examples and may vary from those of other BCC connectors.



# Connectors and Cables

## Dimensions

### M5 connectors, female straight and right-angle

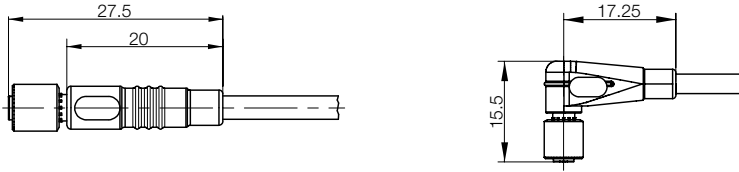

### M8 connectors, male straight and right-angle

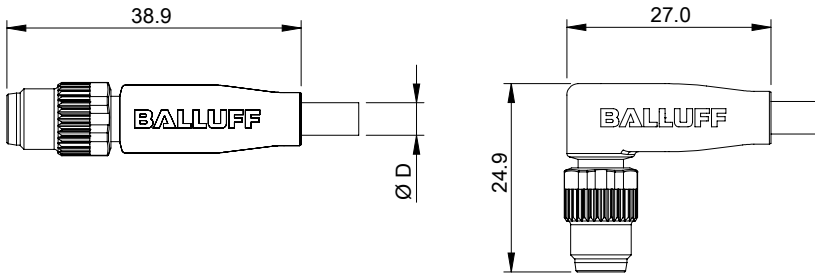

### M8 connectors, female straight and right-angle

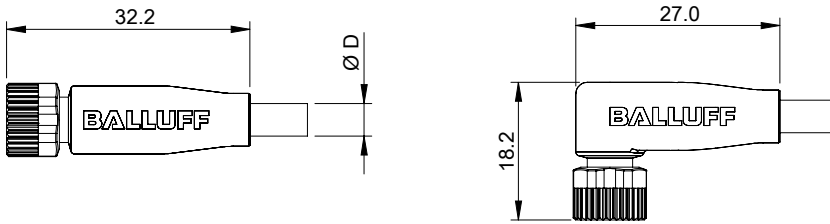

### M12 connectors, male straight and right-angle

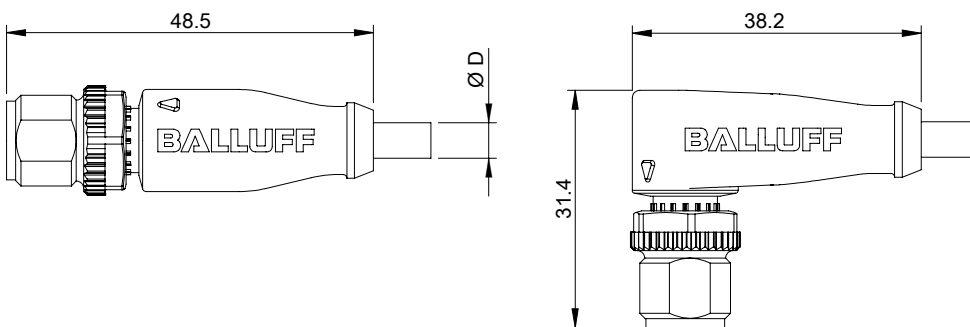

### M12 connectors, female straight and right-angle

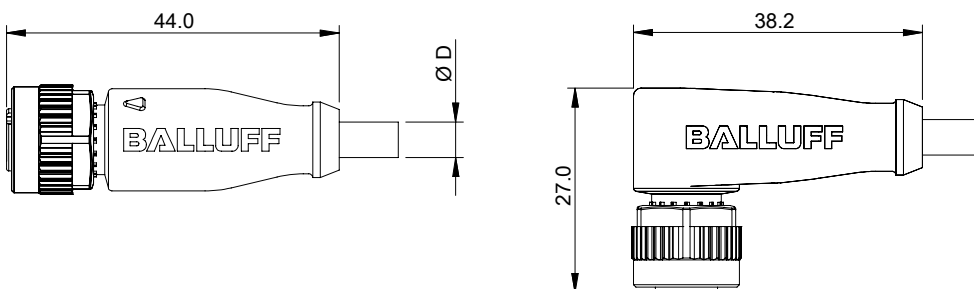

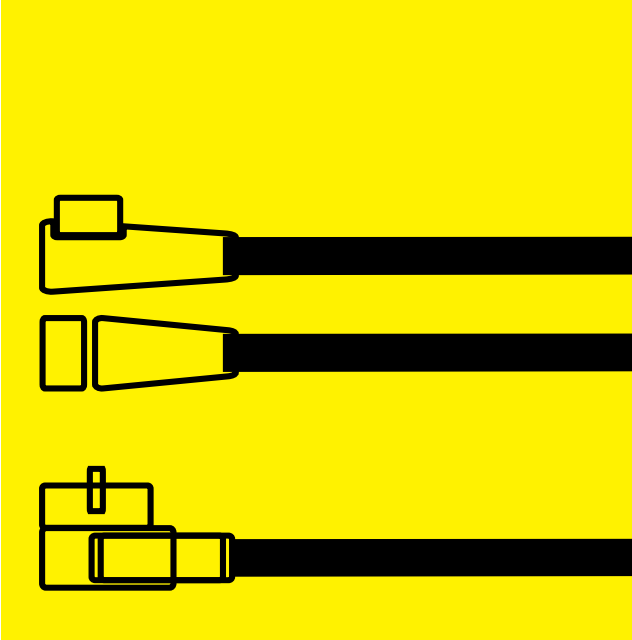

# Connectors and Valve Connectors

Connectors and Cables



# Connectors and Cables

## Contents

### Faster, simpler connection

Clearly visible markings on the grip for easy alignment. The special BCC tool allows you to screw on the connector or set the tightening torque via the hex.

### Highly visible LEDs

The LEDs are clearly visible from various directions, even under difficult lighting conditions.



<b>Connectors M5</b>			266
<b>Cables M5 ↔ M8</b>	3-pin	female/male	268
<b>Connectors M8</b>	3-pin	male	270
	4-pin	male	272
	3-pin	female	271
	4-pin	female	273
	For user assembly		282
	3-pin	flange socket	288
	3-pin	flange plug	288
	4-pin	flange socket	289
	4-pin	flange plug	289
<b>Cables M8 ↔ M8</b>	3-pin	female/male	274
	4-pin	female/male	276
<b>Cables M8 ↔ M12</b>	3-pin	female/male	278
	4-pin	female/male	280
<b>Connectors M12</b>	3-pin	male	290
	4-pin	male	294
	5-pin	male	294
	3-pin	female	291
	4-pin	female	295
	5-pin	female	298
	8-pin	female	300
	12-pin	female	302
	For user assembly		316
	4-pin	flange socket	322
	4-pin	flange plug	322
	5-pin	flange socket	323
	5-pin	flange plug	323
	8-pin	flange socket	323
	8-pin	flange plug	323
	12-pin	flange socket	324
	12-pin	flange plug	324
<b>Cables M12 ↔ M8</b>	3-pin	female/male	304
	4-pin	female/male	306
<b>Cables M12 ↔ M12</b>	3-pin	female/male	308
	4-pin	female/male	310
	5-pin	female/male	312
	8-pin	female/male	315
<b>Tees, adapters</b>	3-pin		325
<b>Y-connectors M12</b>			326
<b>Accessories</b>			327
<b>Special properties</b>			
High-temperature resistant			328
IP 69K-ECOLAB			330
Weld splatter-resistant PUR lines			332
Y-connectors, weld splatter-resistant			344
Pottable connectors			345

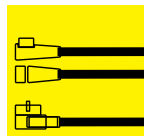





# Connectors

## M5 female straight, 3 and 4-pin, no LED

# M5

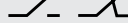

Connector diagram and wiring	 PIN 1: brown PIN 3: blue PIN 4: black		 PIN 1: brown PIN 2: white PIN 3: blue PIN 4: black	
	1 _____ 2 _____ 3 _____ 4 _____	1 _____ 2 _____ 3 _____ 4 _____		
Max. supply voltage AC $U_B$	30 V AC		30 V AC	
Max. supply voltage DC $U_B$	30 V DC		30 V DC	
Cable	Molded		Molded	
Number of conductors × conductor cross-section	3×0.14 mm <sup>2</sup>		4×0.14 mm <sup>2</sup>	
Degree of protection as per IEC 60529	IP 67		IP 67	
Ambient temperature $T_a$	Static PUR: -25...+80 °C Tensioned PUR: -5...+80 °C		-25...+80 °C -5...+80 °C	
Use	Normally open (NO) 		Complementary (NO/NC) 	

Cable material	Color	Length	Ordering code	
PUR	Black	3 m	Part number	
			<b>BCC00HE</b>	<b>BCC00HK</b>
			BKS-B 25-1-PU-03	BKS-B 25-3-PU-03
PUR	Black	5 m		<b>BCC00HL</b>
				BKS-B 25-3-PU-05

Other cable materials, colors, and lengths on request.

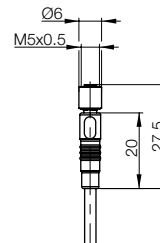
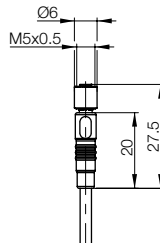

# Connectors

## M5 female right-angle, 3 and 4-pin, without LED



PIN 1: brown  
PIN 3: blue  
PIN 4: black



PIN 1: brown  
PIN 2: white  
PIN 3: blue  
PIN 4: black

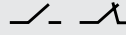

30 V AC  
30 V DC  
Molded  
4x0.14 mm<sup>2</sup>  
IP 67  
-25...+80 °C  
-5...+80 °C  
Normally open (NO) —

30 V AC  
30 V DC  
Molded  
4x0.14 mm<sup>2</sup>  
IP 67  
-25...+80 °C  
-5...+80 °C  
Complementary (NO/NC) — / —

### Ordering code

Part number

**BCC00HM**

BKS-B 26-1-PU-03

**BCC00HP**

BKS-B 26-3-PU-03

**BCC00HR**

BKS-B 26-3-PU-05

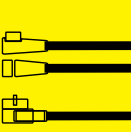
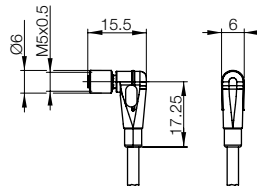
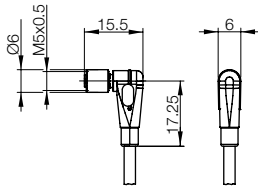

Connectors and cables

**Connectors M5**

Connection cables  
M5↔M8

Connectors M8

Connection cables  
M8↔M8

Connection cables  
M8↔M12

Connectors M12

Connection cables  
M12↔M8

Connection cables  
M12↔M12

Tees, adapters

Y-connector

Accessories

Special properties

# Connection Cables

# M5 ↔ M8

**M5 female straight or right-angle ↔ M8 male straight, 3-pin, no LED**

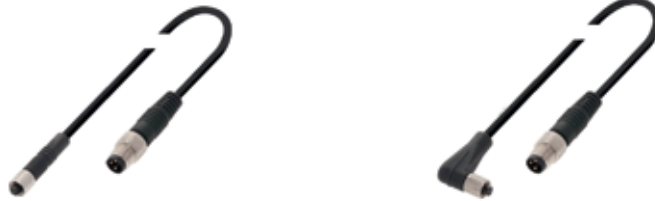

Connector diagram and wiring	 	 
Max. supply voltage AC $U_B$	60 V AC	60 V AC
Max. supply voltage DC $U_B$	60 V DC	60 V DC
Cable	Molded	Molded
Number of conductors × conductor cross-section	3×0.14 mm <sup>2</sup>	3×0.14 mm <sup>2</sup>
Degree of protection as per IEC 60529	IP 67	IP 67
Ambient temperature $T_a$	Static PUR: -25...+80 °C Tensioned PUR: -5...+80 °C	-25...+80 °C -5...+80 °C
Use	Normally open (NO) ✓-	Normally open (NO) ✓-

Cable material	Color	Length	Ordering code	Part number
PUR	Black	0.3 m	<b>BCC00HF</b>	
PUR	Black	0.6 m	<b>BCC00HH</b>	
PUR	Black	1 m	<b>BCC00HJ</b>	<b>BCC00HN</b>
			BKS-B 25-1/GS49-PU-00,3	
			BKS-B 25-1/GS49-PU-00,6	
			BKS-B 25-1/GS49-PU-01	BKS-B 26-1/GS49-PU-01

Other cable materials, colors, and lengths on request.

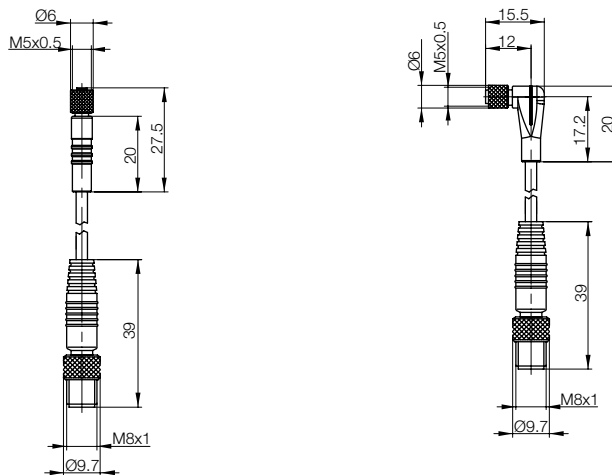

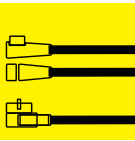

Connectors  
and cables

Connectors  
M5

**Connection  
cables  
M5↔M8**

Connectors  
M8

Connection  
cables  
M8↔M8

Connection  
cables  
M8↔M12

M12 connectors

Connection  
cables  
M12↔M8

Connection  
cables  
M12↔M12

Tees,  
adapters

Y-connector

Accessories

Special  
properties



Connector diagram and wiring	<p>PIN 1: brown PIN 3: blue PIN 4: black</p>	<p>PIN 1: brown PIN 3: blue PIN 4: black</p>
Max. supply voltage AC $U_B$	60 V AC	60 V AC
Max. supply voltage DC $U_B$	60 V DC	60 V DC
Cable	Molded	Molded
Number of conductors × conductor cross-section	3×0.34 mm <sup>2</sup>	3×0.34 mm <sup>2</sup>
Degree of protection as per IEC 60529	IP 67	IP 67
Ambient temperature $T_a$	PUR -25...+90 °C/-25...+90 °C (UL 80 °C)	PUR -25...+90 °C/-25...+90 °C (UL 80 °C)
Static/moving	PVC -25...+105 °C/-5...+90 °C (UL 80 °C)	PVC -25...+105 °C/-5...+90 °C (UL 80 °C)
LED		

Cable material	Color	Length	Ordering code
PUR	Black	2 m	<b>BCC02M2</b>
			BCC M313-0000-20-001-PX0334-020
PUR	Black	5 m	<b>BCC02M3</b>
			BCC M313-0000-20-001-PX0334-050
PUR	Black	10 m	<b>BCC02M4</b>
			BCC M313-0000-20-001-PX0334-100
PVC	Gray	2 m	<b>BCC02NL</b>
			BCC M313-0000-20-001-VX8334-020
PVC	Gray	5 m	<b>BCC02NM</b>
			BCC M313-0000-20-001-VX8334-050
PVC	Gray	10 m	<b>BCC02NN</b>
			BCC M313-0000-20-001-VX8334-100

Other cable materials, colors, and lengths on request.  
Connectors without LED are suitable for PNP and NPN switching functions.  
NPN versions on request.

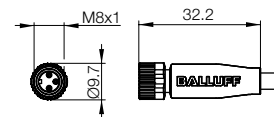
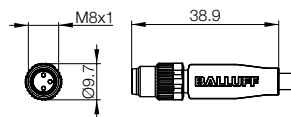



# Connectors

## M8 female straight or right-angle, 3-pin, with and without LED

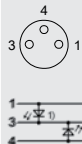

PIN 1: brown  
PIN 3: blue  
PIN 4: black



PIN 1: brown  
PIN 3: blue  
PIN 4: black



PIN 1: brown  
PIN 3: blue  
PIN 4: black



<sup>1)</sup> Green LED = Power  
<sup>2)</sup> Yellow LED = Switching output

30 V DC

Molded

3×0.34 mm<sup>2</sup>

IP 67

-25...+90 °C/-25...+90 °C (UL 80 °C)

-25...+105 °C/-5...+90 °C (UL 80 °C)

Green/yellow

60 V AC

60 V DC

Molded

3×0.34 mm<sup>2</sup>

IP 67

-25...+90 °C/-25...+90 °C (UL 80 °C)

-25...+105 °C/-5...+90 °C (UL 80 °C)

30 V DC

Molded

3×0.34 mm<sup>2</sup>

IP 67

-25...+90 °C/-25...+90 °C (UL 80 °C)

-25...+105 °C/-5...+90 °C (UL 80 °C)

Green/yellow

### Ordering code

Part number

#### BCC0AW9

BCC M313-0000-10-004-PX0334-020

#### BCC02ML

BCC M323-0000-10-001-PX0334-020

#### BCC02MH

BCC M323-0000-10-004-PX0334-020

#### BCC0AWA

BCC M313-0000-10-004-PX0334-050

#### BCC02MM

BCC M323-0000-10-001-PX0334-050

#### BCC02MJ

BCC M323-0000-10-004-PX0334-050

#### BCC0AWC

BCC M313-0000-10-004-PX0334-100

#### BCC02MN

BCC M323-0000-10-001-PX0334-100

#### BCC02MK

BCC M323-0000-10-004-PX0334-100

#### BCC0C06

BCC M313-0000-10-004-VX8334-020

#### BCC02P5

BCC M323-0000-10-001-VX8334-020

#### BCC02P2

BCC M323-0000-10-004-VX8334-020

#### BCC0AY0

BCC M313-0000-10-004-VX8334-050

#### BCC02P6

BCC M323-0000-10-001-VX8334-050

#### BCC02P3

BCC M323-0000-10-004-VX8334-050

#### BCC0C07

BCC M313-0000-10-004-VX8334-100

#### BCC02P7

BCC M323-0000-10-001-VX8334-100

#### BCC02P4

BCC M323-0000-10-004-VX8334-100

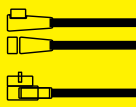
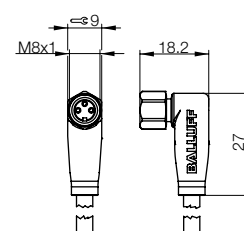
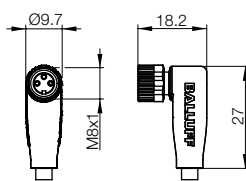
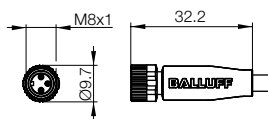

Connectors and cables  
Connectors M5

Connection cables M5↔M8

Connectors M8

Connection cables M8↔M8

Connection cables M8↔M12

Connectors M12

Connection cables M12↔M8

Connection cables M12↔M12

Tees, adapters

Y-connector  
Accessories  
Special properties



Connector diagram and wiring



PIN 1: brown  
PIN 2: white  
PIN 3: blue  
PIN 4: black



PIN 1: brown  
PIN 2: white  
PIN 3: blue  
PIN 4: black



Max. supply voltage AC $U_B$	30 V AC	30 V AC
Max. supply voltage DC $U_B$	30 V DC	30 V DC
Cable	Molded	Molded
Number of conductors × conductor cross-section	4×0.34 mm <sup>2</sup>	4×0.34 mm <sup>2</sup>
Degree of protection as per IEC 60529	IP 67	IP 67
Ambient temperature $T_a$	PUR -25...+90 °C/-25...+90 °C (UL 80 °C)	PUR -25...+90 °C/-25...+90 °C (UL 80 °C)
Static/moving	PVC -25...+105 °C/-5...+90 °C (UL 80 °C)	PVC -25...+105 °C/-5...+90 °C (UL 80 °C)
LED		

Cable material	Color	Length	Ordering code	Part number	
PUR		Black	2 m	<b>BCC02MU</b>	<b>BCC02N2</b>
				BCC M314-0000-20-003-PX0434-020	BCC M314-0000-10-003-PX0434-020
PUR		Black	5 m	<b>BCC02MW</b>	<b>BCC02N3</b>
				BCC M314-0000-20-003-PX0434-050	BCC M314-0000-10-003-PX0434-050
PUR		Black	10 m	<b>BCC02MY</b>	<b>BCC02N4</b>
				BCC M314-0000-20-003-PX0434-100	BCC M314-0000-10-003-PX0434-100
PVC		Gray	2 m	<b>BCC02PC</b>	<b>BCC02PL</b>
				BCC M314-0000-20-003-VX8434-020	BCC M314-0000-10-003-VX8434-020
PVC		Gray	5 m	<b>BCC02PE</b>	<b>BCC02PM</b>
				BCC M314-0000-20-003-VX8434-050	BCC M314-0000-10-003-VX8434-050
PVC		Gray	10 m	<b>BCC02PF</b>	<b>BCC02PN</b>
				BCC M314-0000-20-003-VX8434-100	BCC M314-0000-10-003-VX8434-100

Other cable materials, colors, and lengths on request.

Connectors without LED are suitable for PNP and NPN switching functions.  
NPN versions on request.

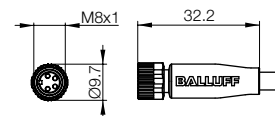
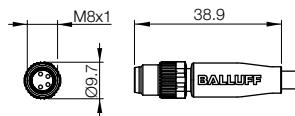

# Connectors

## M8 female right-angle, 4-pin, without and with LED

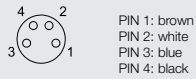

PIN 1: brown  
PIN 2: white  
PIN 3: blue  
PIN 4: black

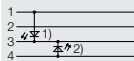

30 V AC

30 V DC

Molded

4x0.34 mm<sup>2</sup>

IP 67

-25...+90 °C/-25...+90 °C (UL 80 °C)

-25...+105 °C/-5...+90 °C (UL 80 °C)

30 V DC

Molded

4x0.34 mm<sup>2</sup>

IP 67

-25...+90 °C/-25...+90 °C (UL 80 °C)

-25...+105 °C/-5...+90 °C (UL 80 °C)

Green/yellow

### Ordering code

Part number

#### BCC02NC

BCC M324-0000-10-003-PX0434-020

#### BCC02NE

BCC M324-0000-10-003-PX0434-050

#### BCC02NF

BCC M324-0000-10-003-PX0434-100

#### BCC02PZ

BCC M324-0000-10-003-VX8434-020

#### BCC02R0

BCC M324-0000-10-003-VX8434-050

#### BCC02R1

BCC M324-0000-10-003-VX8434-100

#### BCC02N8

BCC M324-0000-10-008-PX0434-020

#### BCC02N9

BCC M324-0000-10-008-PX0434-050

#### BCC02NA

BCC M324-0000-10-008-PX0434-100

#### BCC02PU

BCC M324-0000-10-008-VX8434-020

#### BCC02PW

BCC M324-0000-10-008-VX8434-050

#### BCC02PY

BCC M324-0000-10-008-VX8434-100

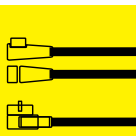
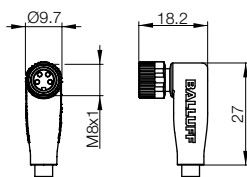
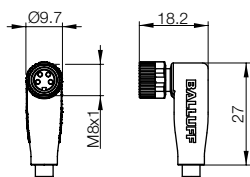

Connectors and cables

Connectors M5

Connection cables M5↔M8

Connectors M8

Connection cables M8↔M8

Connection cables M8↔M12

Connectors M12

Connection cables M12↔M8

Connection cables M12↔M12

Tees, adapters

Y-connectors

Accessories

Special properties

## Connection cable

### M8 female straight ↔ M8 male straight or right-angle, 3-pin, with and without LED



Connector diagram and wiring			
Max. supply voltage AC $U_B$	60 V AC		
Max. supply voltage DC $U_B$	60 V DC	30 V DC	
Cable	Molded	Molded	
Number of conductors × conductor cross-section	3×0.34 mm <sup>2</sup>	3×0.34 mm <sup>2</sup>	
Degree of protection as per IEC 60529	IP 67	IP 67	
Ambient temperature $T_a$	Static PUR Tensioned PUR	Static PUR Tensioned PUR	
LED		Green LED = Power Yellow LED = Switching output	

Cable material	Color	Length	Ordering code	Part number
PUR	Black	0.3 m	<b>BCC02R5</b> BCC M313-M313-30-300-PX0334-003	<b>BCC0AZA</b> BCC M313-M313-30-602-PX0334-003
PUR	Black	0.6 m	<b>BCC02R6</b> BCC M313-M313-30-300-PX0334-006	<b>BCC0AZC</b> BCC M313-M313-30-602-PX0334-006
PUR	Black	1 m	<b>BCC02R7</b> BCC M313-M313-30-300-PX0334-010	<b>BCC0AZE</b> BCC M313-M313-30-602-PX0334-010
PUR	Black	1.5 m	<b>BCC02R8</b> BCC M313-M313-30-300-PX0334-015	<b>BCC0AZF</b> BCC M313-M313-30-602-PX0334-015
PUR	Black	2 m	<b>BCC02R9</b> BCC M313-M313-30-300-PX0334-020	<b>BCC0AZH</b> BCC M313-M313-30-602-PX0334-020
PUR	Black	3 m	<b>BCC02RA</b> BCC M313-M313-30-300-PX0334-030	<b>BCC0AZJ</b> BCC M313-M313-30-602-PX0334-030
PUR	Black	5 m	<b>BCC02RC</b> BCC M313-M313-30-300-PX0334-050	<b>BCC0AZK</b> BCC M313-M313-30-602-PX0334-050
PVC	Gray	0.3 m	<b>BCC02UR</b> BCC M313-M313-30-300-VX8334-003	
PVC	Gray	0.6 m	<b>BCC02UT</b> BCC M313-M313-30-300-VX8334-006	
PVC	Gray	1 m	<b>BCC02UU</b> BCC M313-M313-30-300-VX8334-010	
PVC	Gray	1.5 m	<b>BCC02UW</b> BCC M313-M313-30-300-VX8334-015	
PVC	Gray	2 m	<b>BCC02UY</b> BCC M313-M313-30-300-VX8334-020	
PVC	Gray	3 m	<b>BCC02UZ</b> BCC M313-M313-30-300-VX8334-030	
PVC	Gray	5 m	<b>BCC02W0</b> BCC M313-M313-30-300-VX8334-050	

Other cable materials, colors, and lengths on request.  
Connectors without LED are suitable for PNP and NPN switching functions.  
NPN versions on request.

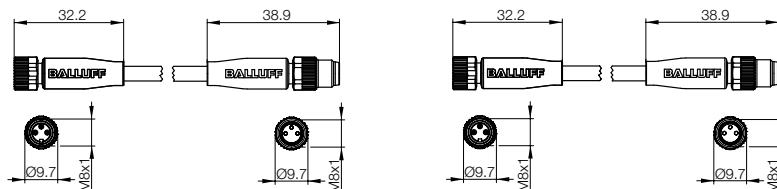

# Connection Cables

## M8 female straight or right-angle ↔ M8 male straight or right-angle, 3-pin, with and without LED

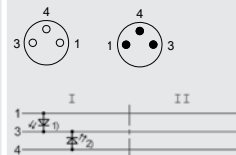
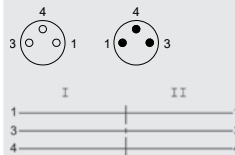
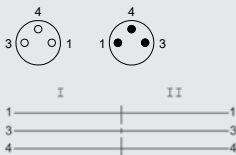

60 V AC  
60 V DC  
Molded  
3×0.34 mm<sup>2</sup>  
IP 67  
-25...+90 °C/-25...+90 °C (UL 80 °C)  
-25...+105 °C/-5...+105 °C (UL 80 °C)

60 V AC  
60 V DC  
Molded  
3×0.34 mm<sup>2</sup>  
IP 67  
-25...+90 °C/-25...+90 °C (UL 80 °C)  
-25...+105 °C/-5...+105 °C (UL 80 °C)

30 V DC  
Molded  
3×0.34 mm<sup>2</sup>  
IP 67  
-25...+90 °C/-25...+90 °C (UL 80 °C)  
-25...+105 °C/-5...+105 °C (UL 80 °C)  
Green/yellow

### Ordering code

Part number

<b>BCC02RE</b> BCC M313-M323-30-300-PX0334-003	<b>BCC02RZ</b> BCC M323-M313-30-300-PX0334-003	<b>BCC02RN</b> BCC M323-M313-30-602-PX0334-003
<b>BCC02RF</b> BCC M313-M323-30-300-PX0334-006	<b>BCC02T0</b> BCC M323-M313-30-300-PX0334-006	<b>BCC02RP</b> BCC M323-M313-30-602-PX0334-006
<b>BCC02RH</b> BCC M313-M323-30-300-PX0334-010	<b>BCC02T1</b> BCC M323-M313-30-300-PX0334-010	<b>BCC02RR</b> BCC M323-M313-30-602-PX0334-010
<b>BCC02RJ</b> BCC M313-M323-30-300-PX0334-015	<b>BCC02T2</b> BCC M323-M313-30-300-PX0334-015	<b>BCC02RT</b> BCC M323-M313-30-602-PX0334-015
<b>BCC02RK</b> BCC M313-M323-30-300-PX0334-020	<b>BCC02T3</b> BCC M323-M313-30-300-PX0334-020	<b>BCC02RU</b> BCC M323-M313-30-602-PX0334-020
<b>BCC02RL</b> BCC M313-M323-30-300-PX0334-030	<b>BCC02T4</b> BCC M323-M313-30-300-PX0334-030	<b>BCC02RW</b> BCC M323-M313-30-602-PX0334-030
<b>BCC02RM</b> BCC M313-M323-30-300-PX0334-050	<b>BCC02T5</b> BCC M323-M313-30-300-PX0334-050	<b>BCC02RY</b> BCC M323-M313-30-602-PX0334-050
<b>BCC02W1</b> BCC M313-M323-30-300-VX8334-003	<b>BCC02WJ</b> BCC M323-M313-30-300-VX8334-003	<b>BCC02W8</b> BCC M323-M313-30-602-VX8334-003
<b>BCC02W2</b> BCC M313-M323-30-300-VX8334-006	<b>BCC02WK</b> BCC M323-M313-30-300-VX8334-006	<b>BCC02W9</b> BCC M323-M313-30-602-VX8334-006
<b>BCC02W3</b> BCC M313-M323-30-300-VX8334-010	<b>BCC02WL</b> BCC M323-M313-30-300-VX8334-010	<b>BCC02WA</b> BCC M323-M313-30-602-VX8334-010
<b>BCC02W4</b> BCC M313-M323-30-300-VX8334-015	<b>BCC02WM</b> BCC M323-M313-30-300-VX8334-015	<b>BCC02WC</b> BCC M323-M313-30-602-VX8334-015
<b>BCC02W5</b> BCC M313-M323-30-300-VX8334-020	<b>BCC02WN</b> BCC M323-M313-30-300-VX8334-020	<b>BCC02WE</b> BCC M323-M313-30-602-VX8334-020
<b>BCC02W6</b> BCC M313-M323-30-300-VX8334-030	<b>BCC02WP</b> BCC M323-M313-30-300-VX8334-030	<b>BCC02WF</b> BCC M323-M313-30-602-VX8334-030
<b>BCC02W7</b> BCC M313-M323-30-300-VX8334-050	<b>BCC02WR</b> BCC M323-M313-30-300-VX8334-050	<b>BCC02WH</b> BCC M323-M313-30-602-VX8334-050

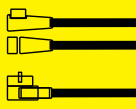

Connectors and cables

Connectors M5

Connection cables M5↔M8

Connectors M8

Connection cables M8↔M8

Connection cables M8↔M12

Connectors M12

Connection cables M12↔M8

Connection cables M12↔M12

Tees, adapters

Y-connectors

Accessories

Special properties

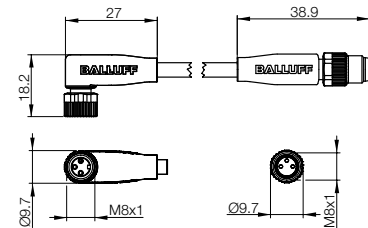
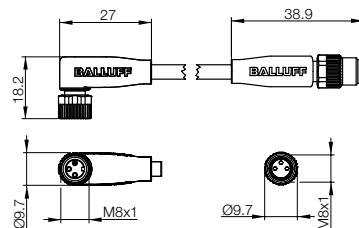
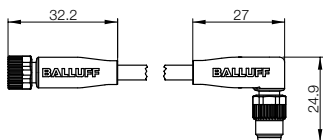

# Connection Cables

## M8 female straight ↔ M8 male straight, 3 or 4-pin, without LED

M8 ↔ M8



Connector diagram and wiring			
Max. supply voltage AC $U_B$	60 V AC	30 V AC	
Max. supply voltage DC $U_B$	60 V DC	30 V DC	
Cable	Molded	Molded	
Number of conductors × conductor cross-section	3×0.34 mm <sup>2</sup>	4×0.34 mm <sup>2</sup>	
Degree of protection as per IEC 60529	IP 67	IP 67	
Ambient temperature $T_a$	PUR	-25...+90 °C / -25...+90 °C (UL 80 °C)	-25...+90 °C / -25...+90 °C (UL 80 °C)
Static/moving	PVC	-25...+105 °C / -5...+105 °C (UL 80 °C)	-25...+105 °C / -5...+105 °C (UL 80 °C)
LED			

Cable material	Color	Length	Ordering code	Part number	
PUR		Black	0.3 m	<b>BCC0CAH</b> BCC M314-M313-30-300-PX0334-003	<b>BCC02TF</b> BCC M314-M314-30-304-PX0434-003
PUR		Black	0.6 m	<b>BCC0AUL</b> BCC M314-M313-30-300-PX0334-006	<b>BCC02TH</b> BCC M314-M314-30-304-PX0434-006
PUR		Black	1 m	<b>BCC0A77</b> BCC M314-M313-30-300-PX0334-010	<b>BCC02TJ</b> BCC M314-M314-30-304-PX0434-010
PUR		Black	1.5 m		<b>BCC02TK</b> BCC M314-M314-30-304-PX0434-015
PUR		Black	2 m	<b>BCC0A78</b> BCC M314-M313-30-300-PX0334-020	<b>BCC02TL</b> BCC M314-M314-30-304-PX0434-020
PUR		Black	3 m	<b>BCC0C6A</b> BCC M314-M313-30-300-PX0334-030	<b>BCC02TM</b> BCC M314-M314-30-304-PX0434-030
PUR		Black	5 m	<b>BCC0C6C</b> BCC M314-M313-30-300-PX0334-050	<b>BCC02TN</b> BCC M314-M314-30-304-PX0434-050
PVC		Gray	0.3 m		<b>BCC02Y2</b> BCC M314-M314-30-304-VX8434-003
PVC		Gray	0.6 m		<b>BCC02Y3</b> BCC M314-M314-30-304-VX8434-006
PVC		Gray	1 m		<b>BCC02Y4</b> BCC M314-M314-30-304-VX8434-010
PVC		Gray	1.5 m		<b>BCC02Y5</b> BCC M314-M314-30-304-VX8434-015
PVC		Gray	2 m		<b>BCC02Y6</b> BCC M314-M314-30-304-VX8434-020
PVC		Gray	3 m		<b>BCC02Y7</b> BCC M314-M314-30-304-VX8434-030
PVC		Gray	5 m		<b>BCC02Y8</b> BCC M314-M314-30-304-VX8434-050

Other cable materials, colors, and lengths on request.  
Connectors without LED are suitable for PNP and NPN switching functions.  
NPN versions on request.

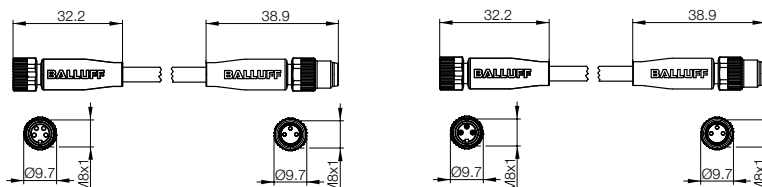

# Connection Cables

**M8 female straight or right-angle ↔ M8 male straight or right-angle, 4-pin, with and without LED**

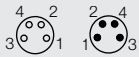

30 V AC  
30 V DC  
Molded  
4×0.34 mm<sup>2</sup>  
IP 67  
-25...+90 °C/-25...+90 °C (UL 80 °C)  
-25...+105 °C/-5...+105 °C (UL 80 °C)

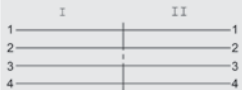

30 V AC  
30 V DC  
Molded  
4×0.34 mm<sup>2</sup>  
IP 67  
-25...+90 °C/-25...+90 °C (UL 80 °C)  
-25...+105 °C/-5...+105 °C (UL 80 °C)

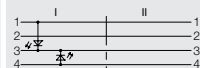
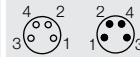

30 V DC  
Molded  
4×0.34 mm<sup>2</sup>  
IP 67  
-25...+90 °C/-25...+90 °C (UL 80 °C)  
-25...+105 °C/-5...+105 °C (UL 80 °C)  
Green/yellow

## Ordering code

Part number

<b>BCC02TP</b> BCC M314-M324-30-304-PX0434-003	<b>BCC02U7</b> BCC M324-M314-30-304-PX0434-003	<b>BCC02U0</b> BCC M324-M314-30-606-PX0434-003
<b>BCC02TR</b> BCC M314-M324-30-304-PX0434-006	<b>BCC02U8</b> BCC M324-M314-30-304-PX0434-006	<b>BCC02U1</b> BCC M324-M314-30-606-PX0434-006
<b>BCC02TT</b> BCC M314-M324-30-304-PX0434-010	<b>BCC02U9</b> BCC M324-M314-30-304-PX0434-010	<b>BCC02U2</b> BCC M324-M314-30-606-PX0434-010
<b>BCC02TU</b> BCC M314-M324-30-304-PX0434-015	<b>BCC02UA</b> BCC M324-M314-30-304-PX0434-015	<b>BCC02U3</b> BCC M324-M314-30-606-PX0434-015
<b>BCC02TW</b> BCC M314-M324-30-304-PX0434-020	<b>BCC02UC</b> BCC M324-M314-30-304-PX0434-020	<b>BCC02U4</b> BCC M324-M314-30-606-PX0434-020
<b>BCC02TY</b> BCC M314-M324-30-304-PX0434-030	<b>BCC02UE</b> BCC M324-M314-30-304-PX0434-030	<b>BCC02U5</b> BCC M324-M314-30-606-PX0434-030
<b>BCC02TZ</b> BCC M314-M324-30-304-PX0434-050	<b>BCC02UF</b> BCC M324-M314-30-304-PX0434-050	<b>BCC02U6</b> BCC M324-M314-30-606-PX0434-050
<b>BCC02Y9</b> BCC M314-M324-30-304-VX8434-003	<b>BCC02YU</b> BCC M324-M314-30-304-VX8434-003	<b>BCC02YK</b> BCC M324-M314-30-606-VX8434-003
<b>BCC02YA</b> BCC M314-M324-30-304-VX8434-006	<b>BCC02YW</b> BCC M324-M314-30-304-VX8434-006	<b>BCC02YL</b> BCC M324-M314-30-606-VX8434-006
<b>BCC02YC</b> BCC M314-M324-30-304-VX8434-010	<b>BCC02YY</b> BCC M324-M314-30-304-VX8434-010	<b>BCC02YM</b> BCC M324-M314-30-606-VX8434-010
<b>BCC02YE</b> BCC M314-M324-30-304-VX8434-015	<b>BCC02YZ</b> BCC M324-M314-30-304-VX8434-015	<b>BCC02YN</b> BCC M324-M314-30-606-VX8434-015
<b>BCC02YF</b> BCC M314-M324-30-304-VX8434-020	<b>BCC02Z0</b> BCC M324-M314-30-304-VX8434-020	<b>BCC02YP</b> BCC M324-M314-30-606-VX8434-020
<b>BCC02YH</b> BCC M314-M324-30-304-VX8434-030	<b>BCC02Z1</b> BCC M324-M314-30-304-VX8434-030	<b>BCC02YR</b> BCC M324-M314-30-606-VX8434-030
<b>BCC02YJ</b> BCC M314-M324-30-304-VX8434-050	<b>BCC02Z2</b> BCC M324-M314-30-304-VX8434-050	<b>BCC02YT</b> BCC M324-M314-30-606-VX8434-050

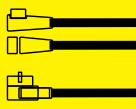

Connectors and cables

Connectors M5

Connection cables M5↔M8

Connectors M8

Connection cables M8↔M8

Connection cables M8↔M12

Connectors M12

Connection cables M12↔M8

Connection cables M12↔M12

Tees, adapters

Y-connectors

Accessories

Special properties

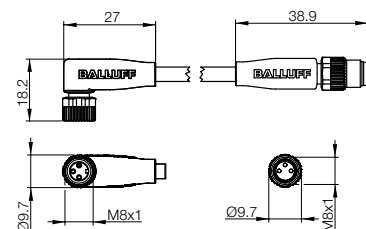
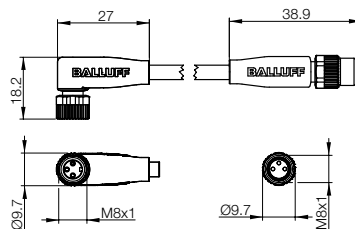
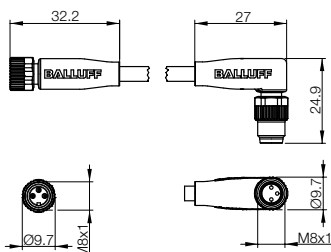

## M8 female straight or right-angle ↔ M12 male straight 3-pin, without LED



Connector diagram and wiring		
Max. supply voltage AC U <sub>B</sub>	60 V AC	60 V AC
Max. supply voltage DC U <sub>B</sub>	60 V DC	60 V DC
Cable	Molded	Molded
Number of conductors × conductor cross-section	3×0.34 mm <sup>2</sup>	3×0.34 mm <sup>2</sup>
Degree of protection as per IEC 60529	IP 67	IP 67
Ambient temperature T <sub>a</sub>	PUR -25...+90 °C / -25...+90 °C (UL 80 °C)	PUR -25...+90 °C / -25...+90 °C (UL 80 °C)
Static/moving	PVC -25...+105 °C / -5...+90 °C (UL 80 °C)	PVC -25...+105 °C / -5...+90 °C (UL 80 °C)
LED		

Cable material	Color	Length	Ordering code	Part number
PUR	Black	0.3 m	<b>BCC03F4</b>	<b>BCC03FM</b>
			BCC M313-M413-3E-300-PX0334-003	BCC M323-M413-3E-300-PX0334-003
PUR	Black	0.6 m	<b>BCC03F5</b>	<b>BCC03FN</b>
			BCC M313-M413-3E-300-PX0334-006	BCC M323-M413-3E-300-PX0334-006
PUR	Black	1 m	<b>BCC03F6</b>	<b>BCC03FP</b>
			BCC M313-M413-3E-300-PX0334-010	BCC M323-M413-3E-300-PX0334-010
PUR	Black	1.5 m	<b>BCC03F7</b>	<b>BCC03FR</b>
			BCC M313-M413-3E-300-PX0334-015	BCC M323-M413-3E-300-PX0334-015
PUR	Black	2 m	<b>BCC03F8</b>	<b>BCC03FT</b>
			BCC M313-M413-3E-300-PX0334-020	BCC M323-M413-3E-300-PX0334-020
PUR	Black	3 m	<b>BCC03F9</b>	<b>BCC03FU</b>
			BCC M313-M413-3E-300-PX0334-030	BCC M323-M413-3E-300-PX0334-030
PUR	Black	5 m	<b>BCC03FA</b>	<b>BCC03FW</b>
			BCC M313-M413-3E-300-PX0334-050	BCC M323-M413-3E-300-PX0334-050
PVC	Gray	0.3 m	<b>BCC03HE</b>	<b>BCC03HZ</b>
			BCC M313-M413-3E-300-VX8334-003	BCC M323-M413-3E-300-VX8334-003
PVC	Gray	0.6 m	<b>BCC03HF</b>	<b>BCC03J0</b>
			BCC M313-M413-3E-300-VX8334-006	BCC M323-M413-3E-300-VX8334-006
PVC	Gray	1 m	<b>BCC03HH</b>	<b>BCC03J1</b>
			BCC M313-M413-3E-300-VX8334-010	BCC M323-M413-3E-300-VX8334-010
PVC	Gray	1.5 m	<b>BCC03HJ</b>	<b>BCC03J2</b>
			BCC M313-M413-3E-300-VX8334-015	BCC M323-M413-3E-300-VX8334-015
PVC	Gray	2 m	<b>BCC03HK</b>	<b>BCC03J3</b>
			BCC M313-M413-3E-300-VX8334-020	BCC M323-M413-3E-300-VX8334-020
PVC	Gray	3 m	<b>BCC03HL</b>	<b>BCC03J4</b>
			BCC M313-M413-3E-300-VX8334-030	BCC M323-M413-3E-300-VX8334-030
PVC	Gray	5 m	<b>BCC03HM</b>	<b>BCC03J5</b>
			BCC M313-M413-3E-300-VX8334-050	BCC M323-M413-3E-300-VX8334-050

Other cable materials, colors, and lengths on request.  
Connectors without LED are suitable for PNP and NPN switching functions.  
NPN versions on request.

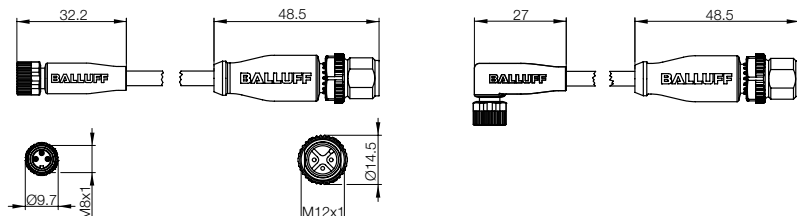



# Connection Cables

## M8 female right-angle ↔ M12 male straight, 3-pin, with LED

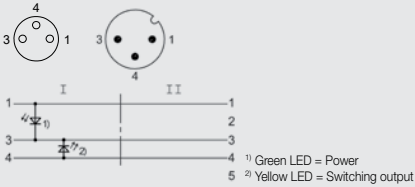

30 V DC  
Molded  
3×0.34 mm<sup>2</sup>  
IP 67  
-25...+90 °C/-25...+90 °C (UL 80 °C)  
-25...+105 °C/-5...+90 °C (UL 80 °C)  
Green/yellow

### Ordering code

Part number

#### BCC03H5

BCC M323-M413-3E-602-PX0334-003

#### BCC03H6

BCC M323-M413-3E-602-PX0334-006

#### BCC03H7

BCC M323-M413-3E-602-PX0334-010

#### BCC03H8

BCC M323-M413-3E-602-PX0334-015

#### BCC03H9

BCC M323-M413-3E-602-PX0334-020

#### BCC03HA

BCC M323-M413-3E-602-PX0334-030

#### BCC03HC

BCC M323-M413-3E-602-PX0334-050

#### BCC03JF

BCC M323-M413-3E-602-VX8334-003

#### BCC03JH

BCC M323-M413-3E-602-VX8334-006

#### BCC03JJ

BCC M323-M413-3E-602-VX8334-010

#### BCC03JK

BCC M323-M413-3E-602-VX8334-015

#### BCC03JL

BCC M323-M413-3E-602-VX8334-020

#### BCC03JM

BCC M323-M413-3E-602-VX8334-030

#### BCC03JN

BCC M323-M413-3E-602-VX8334-050

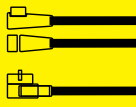

Connectors and cables

Connectors M5

Connection cables M5↔M8

Connectors M8

Connection cables M8↔M8

Connection cables M8↔M12

Connectors M12

Connection cables M12↔M8

Connection cables M12↔M12

Tees, adapters

Y-connectors

Accessories

Special properties

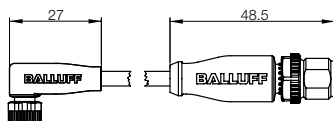

## M8 female straight or right-angle ↔ M12 male straight 4-pin, without LED



Connector diagram and wiring			
Max. supply voltage AC $U_B$	30 V AC	30 V AC	
Max. supply voltage DC $U_B$	30 V DC	30 V DC	
Cable	Molded	Molded	
Number of conductors × conductor cross-section	4×0.34 mm <sup>2</sup>	4×0.34 mm <sup>2</sup>	
Degree of protection as per IEC 60529	IP 67	IP 67	
Ambient temperature $T_a$	PUR -25...+90 °C / -25...+90 °C (UL 80 °C)	PUR -25...+90 °C / -25...+90 °C (UL 80 °C)	
Static/moving	PVC -25...+105 °C / -5...+90 °C (UL 80 °C)	PVC -25...+105 °C / -5...+90 °C (UL 80 °C)	
LED			

Cable material	Color	Length	Ordering code	
			Part number	
PUR	Black	0.3 m	<b>BCC03JP</b>	<b>BCC03K7</b>
			BCC M314-M414-3E-304-PX0434-003	BCC M324-M414-3E-304-PX0434-003
PUR	Black	0.6 m	<b>BCC03JR</b>	<b>BCC03K8</b>
			BCC M314-M414-3E-304-PX0434-006	BCC M324-M414-3E-304-PX0434-006
PUR	Black	1 m	<b>BCC03JT</b>	<b>BCC03K9</b>
			BCC M314-M414-3E-304-PX0434-010	BCC M324-M414-3E-304-PX0434-010
PUR	Black	1.5 m	<b>BCC03JU</b>	<b>BCC03KA</b>
			BCC M314-M414-3E-304-PX0434-015	BCC M324-M414-3E-304-PX0434-015
PUR	Black	2 m	<b>BCC03JW</b>	<b>BCC03KC</b>
			BCC M314-M414-3E-304-PX0434-020	BCC M324-M414-3E-304-PX0434-020
PUR	Black	3 m	<b>BCC03JY</b>	<b>BCC03KE</b>
			BCC M314-M414-3E-304-PX0434-030	BCC M324-M414-3E-304-PX0434-030
PUR	Black	5 m	<b>BCC03JZ</b>	<b>BCC03KF</b>
			BCC M314-M414-3E-304-PX0434-050	BCC M324-M414-3E-304-PX0434-050
PVC	Gray	0.3 m	<b>BCC03L1</b>	<b>BCC03LJ</b>
			BCC M314-M414-3E-304-VX8434-003	BCC M324-M414-3E-304-VX8434-003
PVC	Gray	0.6 m	<b>BCC03L2</b>	<b>BCC03LK</b>
			BCC M314-M414-3E-304-VX8434-006	BCC M324-M414-3E-304-VX8434-006
PVC	Gray	1 m	<b>BCC03L3</b>	<b>BCC03LL</b>
			BCC M314-M414-3E-304-VX8434-010	BCC M324-M414-3E-304-VX8434-010
PVC	Gray	1.5 m	<b>BCC03L4</b>	<b>BCC03LM</b>
			BCC M314-M414-3E-304-VX8434-015	BCC M324-M414-3E-304-VX8434-015
PVC	Gray	2 m	<b>BCC03L5</b>	<b>BCC03LN</b>
			BCC M314-M414-3E-304-VX8434-020	BCC M324-M414-3E-304-VX8434-020
PVC	Gray	3 m	<b>BCC03L6</b>	<b>BCC03LP</b>
			BCC M314-M414-3E-304-VX8434-030	BCC M324-M414-3E-304-VX8434-030
PVC	Gray	5 m	<b>BCC03L7</b>	<b>BCC03LR</b>
			BCC M314-M414-3E-304-VX8434-050	BCC M324-M414-3E-304-VX8434-050

Other cable materials, colors, and lengths on request.  
 Connectors without LED are suitable for PNP and NPN switching functions.  
 NPN versions on request.

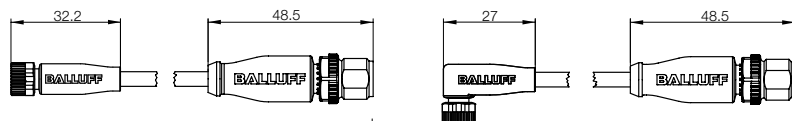

# Connection Cables

## M8 female right-angle ↔ M12 male straight, 4-pin, with LED

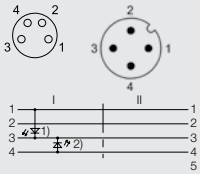

30 V DC  
 Molded  
 4×0.34 mm<sup>2</sup>  
 IP 67  
 -25...+90 °C/-25...+90 °C (UL 80 °C)  
 -25...+105 °C/-5...+90 °C (UL 80 °C)  
 Green/yellow

### Ordering code

Part number

<b>BCC03KR</b>	BCC M324-M414-3E-606-PX0434-003
<b>BCC03KT</b>	BCC M324-M414-3E-606-PX0434-006
<b>BCC03KU</b>	BCC M324-M414-3E-606-PX0434-010
<b>BCC03KW</b>	BCC M324-M414-3E-606-PX0434-015
<b>BCC03KY</b>	BCC M324-M414-3E-606-PX0434-020
<b>BCC03KZ</b>	BCC M324-M414-3E-606-PX0434-030
<b>BCC03L0</b>	BCC M324-M414-3E-606-PX0434-050
<b>BCC03M2</b>	BCC M324-M414-3E-606-VX8434-003
<b>BCC03M3</b>	BCC M324-M414-3E-606-VX8434-006
<b>BCC03M4</b>	BCC M324-M414-3E-606-VX8434-010
<b>BCC03M5</b>	BCC M324-M414-3E-606-VX8434-015
<b>BCC03M6</b>	BCC M324-M414-3E-606-VX8434-020
<b>BCC03M7</b>	BCC M324-M414-3E-606-VX8434-030
<b>BCC03M8</b>	BCC M324-M414-3E-606-VX8434-050

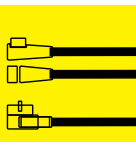

Connectors and cables  
 Connectors M5  
 Connection cables M5↔M8  
 Connectors M8  
 Connection cables M8↔M8  
**Connection cables M8↔M12**  
 Connectors M12  
 Connection cables M12↔M8  
 Connection cables M12↔M12  
 Tees, adapters  
 Y-connectors  
 Accessories  
 Special properties

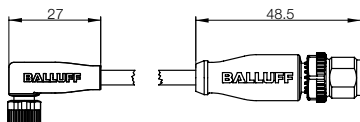

Connectors  
**M8 female straight,**  
**User-fabricated, 3-pin**

M8



Connector diagram			
Version	Female straight	Female straight	
Max. supply voltage AC U <sub>B</sub>	60 V	60 V	
Max. supply voltage DC U <sub>B</sub>	60 V	60 V	
Cable	User-fabricated	User-fabricated	
Number of conductors × conductor cross-section	3×0.14...0.5 mm <sup>2</sup>	3×0.14...0.5 mm <sup>2</sup>	
Cable diameter	Ø 3.5...5 mm	Ø 3.5...5 mm	
Connection	Screw terminal	Soldered connection	
Degree of protection as per IEC 60529	IP 67	IP 67	
Ambient temperature T <sub>a</sub>	-25...+85 °C	-25...+85 °C	
<b>Switching function</b>	<b>Ordering code</b>		
No LED, NC or NO	Part number		
	<b>BCC06Z1</b>	<b>BCC06YW</b>	
	BCC M333-0000-10-000-31X350-000	BCC M333-0000-10-000-34X325-000	

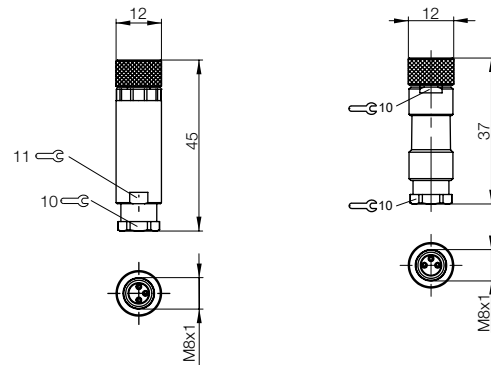

# Connectors

## M8 female right-angle, M8 male straight or right-angle, User-fabricated, 3-pin



Female right-angle	Male straight	Male straight	Male right-angle
60 V	60 V	60 V	60 V
60 V	60 V	60 V	60 V
User-fabricated	User-fabricated	User-fabricated	User-fabricated
3x0.14...0.5 mm <sup>2</sup>	3x0.14...0.5 mm <sup>2</sup>	3x0.14...0.5 mm <sup>2</sup>	3x0.14...0.5 mm <sup>2</sup>
Ø 3.5...5 mm	Ø 2.2...5 mm	Ø 3.5...5 mm	Ø 3.5...5 mm
Soldered connection	Screw terminal	Soldered connection	Soldered connection
IP 67	IP 67	IP 67	IP 67
-25...+85 °C	-25...+85 °C	-25...+85 °C	-25...+85 °C

Ordering code			
Part number			
<b>BCC06YY</b>	<b>BCC0E7N</b>	<b>BCC06YZ</b>	<b>BCC06Z0</b>
BCC M343-0000-10-000-34X325-000	BCC M333-0000-20-000-31X350-000-C027	BCC M333-0000-20-000-34X325-000	BCC M343-0000-20-000-34X325-000

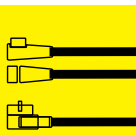
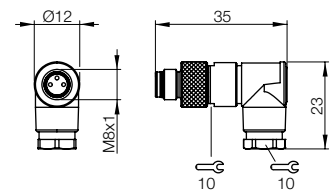
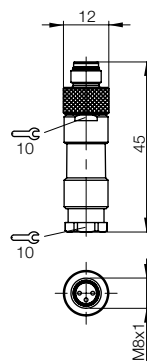
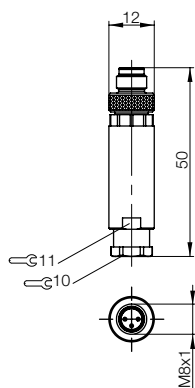
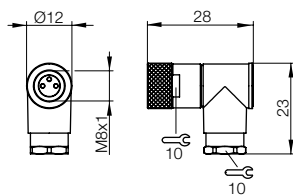

- Connectors and cables
- Connectors M5
- Connection cables M5↔M8
- Connectors M8**
- Connection cables M8↔M8
- Connection cables M8↔M12
- Connectors M12
- Connection cables M12↔M8
- Connection cables M12↔M12
- Tees, adapters
- Y-connectors
- Accessories
- Special properties



Quick-connect system



Quick-connect system

Connector diagram			
Version	Female straight	Male straight	
Max. supply voltage AC U <sub>B</sub>	32 V DC	32 V DC	
Max. supply voltage DC U <sub>B</sub>	32 V DC	32 V DC	
Cable	User-fabricated	User-fabricated	
Number of conductors × conductor cross-section	3×0.14...0.34 mm <sup>2</sup>	3×0.14...0.34 mm <sup>2</sup>	
Cable diameter min.	Ø 3.2...5.4 mm	Ø 3.2...5.4 mm	
Connection	Insulation displacement connector technology	Insulation displacement connector technology	
Degree of protection as per IEC 60529	IP 67	IP 67	
Ambient temperature T <sub>a</sub>	-25...+85 °C*	-25...+85 °C*	
<b>Switching function</b>	<b>Ordering code</b>		
No LED, NC or NO	Part number		
	<b>BCC02HC</b>	<b>BCC02HE</b>	
No LED, NO and NC	BKS-S111-RT13	BKS-S113-RT13	

\*Cable installation on the plug in the temperature range -5...+50 °C

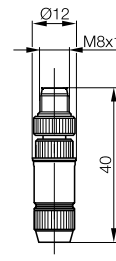
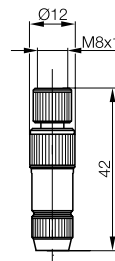

# Connectors

## M8 female straight, M8 male straight, User-fabricated, 3 and 4-pin



Quick-connect system



Quick-connect system



Female straight

32 V DC

32 V DC

User-fabricated

4x0.14...0.34 mm<sup>2</sup>

Ø 3.2...5.4 mm

Insulation displacement connector technology

IP 67

-25...+85 °C\*

Male straight

32 V DC

32 V DC

User-fabricated

4x0.14...0.34 mm<sup>2</sup>

Ø 3.2...5.4 mm

Insulation displacement connector technology

IP 67

-25...+85 °C\*

Female straight

60 V DC

60 V DC

User-fabricated

3x0.14...0.38 mm<sup>2</sup>

Ø 3...5 mm

Penetration technology

IP 67

-25...+85 °C\*

Male straight

60 V DC

60 V DC

User-fabricated

3x0.14...0.38 mm<sup>2</sup>

Ø 3...5 mm

Penetration technology

IP 67

-25...+85 °C\*

### Ordering code

Part number

### BCC09EU

BCC M333-0000-10-000-22X334-000

### BCC09EW

BCC M333-0000-20-000-22X334-000

### BCC02HF

BKS-S216-RT14

### BCC02HH

BKS-S218-RT14

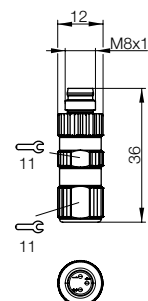
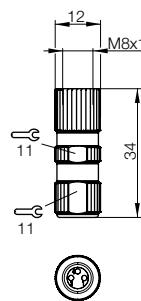
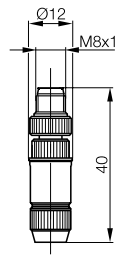
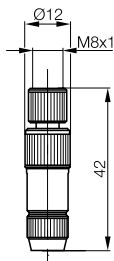

Connectors and cables

Connectors M5

Connection cables M5↔M8

Connectors M8

Connection cables M8↔M8

Connection cables M8↔M12

Connectors M12

Connection cables M12↔M8

Connection cables M12↔M12

Tees, adapters

Y-connectors

Accessories

Special properties



Connector diagram		
Version	Female straight	Male straight
Max. supply voltage AC U <sub>B</sub>	30 V	30 V
Max. supply voltage DC U <sub>B</sub>	30 V	30 V
Cable	User-fabricated	User-fabricated
Number of conductors × conductor cross-section	4×0.14...0.38 mm <sup>2</sup>	4×0.14...0.38 mm <sup>2</sup>
Cable diameter min.	∅ 3...5 mm	∅ 3...5 mm
Degree of protection as per IEC 60529	IP 67	IP 67
Ambient temperature T <sub>a</sub>	-25...+85 °C	-25...+85 °C
<b>Switching function</b>	<b>Ordering code</b>	
No LED, NO and NC	Part number	
	<b>BCC09EY</b>	<b>BCC09EZ</b>
	BCC M334-0000-10-000-22X434-000	BCC M334-0000-20-000-22X434-000

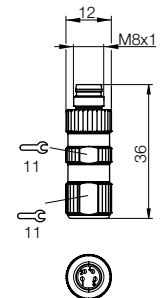
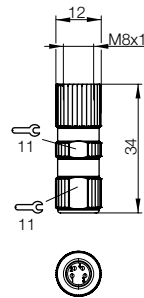



# Connectors

## Y-connector

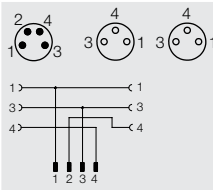
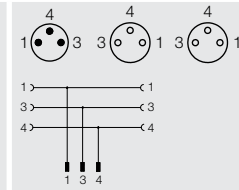

Connector diagram and wiring		
Max. supply voltage AC $U_B$	30 V	30 V
Max. supply voltage DC $U_B$	30 V	30 V
Cable	Molded	Molded
Number of conductors × conductor cross-section	3×0.14 mm <sup>2</sup>	3×0.14 mm <sup>2</sup>
Degree of protection as per IEC 60529	IP 67	IP 67
Ambient temperature $T_a$	-25...+85 °C	-25...+85 °C

Cable material	Color	Length	Ordering code
PUR	Black	0.3 m	Part number <b>BCC0AFL</b> BCC M314-M313-M313-U2024-003
PUR	Black	1 m	<b>BCC0AFM</b> BCC M314-M313-M313-U2024-010
			<b>BCC0A07</b> BCC M313-M313-M313-U2017-003

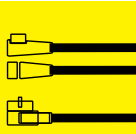

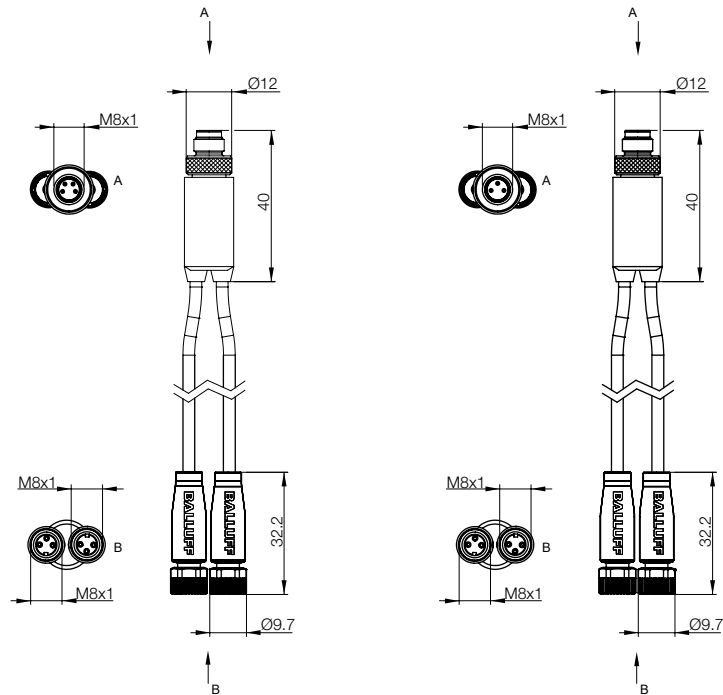

Other cable lengths on request.



Connectors and cables  
Connectors M5  
Connection cables M5↔M8  
**Connectors M8**  
Connection cables M8↔M8  
Connection cables M8↔M12  
Connectors M12  
Connection cables M12↔M8  
Connection cables M12↔M12  
Tees, adapters  
**Y-connectors**  
Accessories  
Special properties



Connector diagram and wiring	 PIN 1: brown PIN 3: blue PIN 4: black	 PIN 1: brown PIN 2: black PIN 3: blue
Max. supply voltage AC $U_B$	30 V	30 V
Max. supply voltage DC $U_B$	30 V	30 V
Number of conductors x conductor cross-section	3x0.25 mm <sup>2</sup>	3x0.25 mm <sup>2</sup>
Degree of protection as per IEC 60529	IP 67	IP 67
Ambient temperature $T_a$	-25...+85 °C	-25...+85 °C

Cable length	Ordering code
	Part number
0.5 m	<b>BCC0E4Y</b> BCC M353-0000-10-RM049-005 <b>BCC0E50</b> BCC M353-0000-20-RM049-005
2 m	<b>BCC0E4Z</b> BCC M353-0000-10-RM049-020 <b>BCC0E51</b> BCC M353-0000-20-RM049-020

Other cable lengths on request.

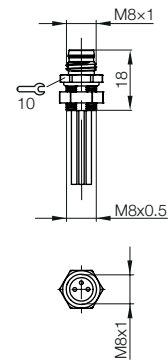
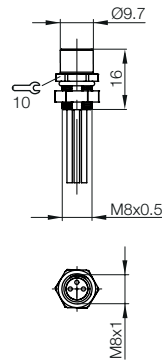

# Connectors

## M8 flange socket, M8 flange plug, 4-pin



PIN 1: brown  
PIN 2: white  
PIN 3: blue  
PIN 4: black



PIN 1: brown  
PIN 2: white  
PIN 3: blue  
PIN 4: black



30 V

30 V

4x0.25 mm<sup>2</sup>

IP 67

-25...+85 °C

30 V

30 V

4x0.25 mm<sup>2</sup>

IP 67

-25...+85 °C

### Ordering code

Part number

**BCC0E35**

BCC M354-0000-10-RM050-005

**BCC0E2Z**

BCC M354-0000-20-RM050-005

**BCC0E38**

BCC M354-0000-10-RM050-020

**BCC0E32**

BCC M354-0000-20-RM050-020

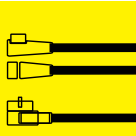
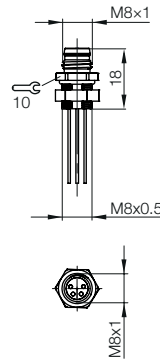
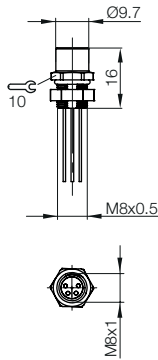

Connectors and cables

Connectors M5

Connection cables M5↔M8

Connectors M8

Connection cables M8↔M8

Connection cables M8↔M12

Connectors M12

Connection cables M12↔M8

Connection cables M12↔M12

Tees, adapters

Y-connectors

Accessories

Special properties

# Connectors

## M12 male straight, 3-pin, no LED

# M12



Connector diagram and wiring	 PIN 1: brown PIN 3: blue PIN 4: black	 PIN 1: brown PIN 2: black PIN 3: blue
Max. supply voltage AC $U_B$	250 V AC	250 V AC
Max. supply voltage DC $U_B$	250 V DC	250 V DC
Cable	Molded	Molded
Number of conductors × conductor cross-section	3×0.34 mm <sup>2</sup>	3×0.34 mm <sup>2</sup>
Degree of protection as per IEC 60529	IP 68	IP 68
Ambient temperature $T_a$	PUR -40...+90 °C/-25...+90 °C (UL 80° C)	PUR -40...+90 °C/-25...+90 °C (UL 80° C)
Static/moving	PUR shielded -40...+80 °C/-25...+80 °C	PUR shielded -40...+80 °C/-25...+80 °C
	PVC -40...+105 °C/-5...+105 °C (UL 80 °C)	PVC -40...+105 °C/-5...+105 °C (UL 80 °C)
	PVC shielded -20...+105 °C (UL 80 °C)	PVC shielded -20...+105 °C (UL 80 °C)
Use	Normally open (NO)	Normally closed (NC)
LED		

Cable material	Color	Length	Ordering code		
			Part number		
PUR		Black	2 m	<b>BCC02ZA</b>	<b>BCC02ZF</b>
				BCC M413-0000-2A-001-PX0334-020	BCC M413-0000-2A-002-PX0334-020
PUR		Black	5 m	<b>BCC02ZC</b>	<b>BCC02ZH</b>
				BCC M413-0000-2A-001-PX0334-050	BCC M413-0000-2A-002-PX0334-050
PUR		Black	10 m	<b>BCC02ZE</b>	<b>BCC02ZJ</b>
				BCC M413-0000-2A-001-PX0334-100	BCC M413-0000-2A-002-PX0334-100
PUR shielded		Black	2 m	<b>BCC02ZK</b>	<b>BCC02ZN</b>
				BCC M413-0000-2A-036-PS0334-020	BCC M413-0000-2A-037-PS0334-020
PUR shielded		Black	5 m	<b>BCC02ZL</b>	<b>BCC02ZP</b>
				BCC M413-0000-2A-036-PS0334-050	BCC M413-0000-2A-037-PS0334-050
PUR shielded		Black	10 m	<b>BCC02ZM</b>	<b>BCC02ZR</b>
				BCC M413-0000-2A-036-PS0334-100	BCC M413-0000-2A-037-PS0334-100
PVC		Gray	2 m	<b>BCC0334</b>	<b>BCC0337</b>
PVC		Gray	5 m	<b>BCC0335</b>	<b>BCC0338</b>
				BCC M413-0000-2A-001-VX8334-050	BCC M413-0000-2A-002-VX8334-050
PVC		Gray	10 m	<b>BCC0336</b>	<b>BCC0339</b>
				BCC M413-0000-2A-001-VX8334-100	BCC M413-0000-2A-002-VX8334-100
PVC shielded		Gray	2 m	<b>BCC033A</b>	<b>BCC033F</b>
				BCC M413-0000-2A-036-VS8334-020	BCC M413-0000-2A-037-VS8334-020
PVC shielded		Gray	5 m	<b>BCC033C</b>	<b>BCC033H</b>
				BCC M413-0000-2A-036-VS8334-050	BCC M413-0000-2A-037-VS8334-050
PVC shielded		Gray	10 m	<b>BCC033E</b>	<b>BCC033J</b>
				BCC M413-0000-2A-036-VS8334-100	BCC M413-0000-2A-037-VS8334-100

Other cable materials, colors, and lengths on request.  
 Connectors without LED are suitable for PNP and NPN switching functions.  
 NPN versions on request.

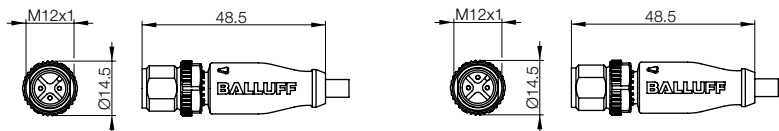

# Connectors

## M12 female straight, 3-pin, with and without LED

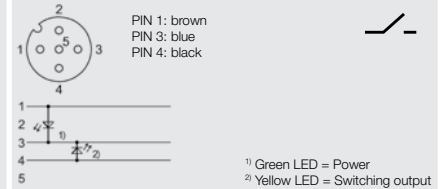
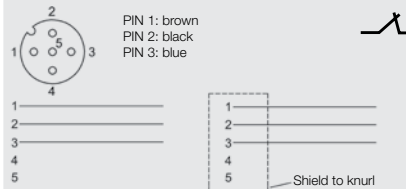
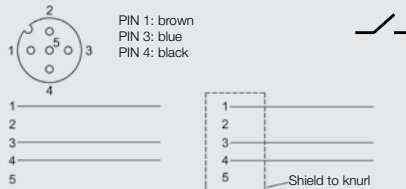

250 V AC	250 V AC	30 V DC
250 V DC	250 V DC	
Molded	Molded	Molded
3×0.34 mm <sup>2</sup>	3×0.34 mm <sup>2</sup>	3×0.34 mm <sup>2</sup>
IP 68	IP 68	IP 68
-40...+90 °C/-25...+90 °C (UL 80° C)	-40...+90 °C/-25...+90 °C (UL 80° C)	-40...+90 °C/-25...+90 °C (UL 80° C)
-40...+80 °C/-25...+80 °C	-40...+80 °C/-25...+80 °C	
-40...+105 °C/-5...+105 °C (UL 80 °C)	-40...+105 °C/-5...+105 °C (UL 80 °C)	-40...+105 °C/-5...+105 °C (UL 80 °C)
-20...+105 °C (UL 80 °C)	-20...+105 °C (UL 80 °C)	
Normally open (NO) —/—	Normally closed (NC) —/—	PNP normally open (NO) —/— Green/yellow

### Ordering code

Part number

Ordering code	Ordering code	Ordering code
<b>BCC030K</b>	<b>BCC030N</b>	<b>BCC030A</b>
BCC M415-0000-1A-001-PX0334-020	BCC M415-0000-1A-002-PX0334-020	BCC M415-0000-1A-004-PX0334-020
<b>BCC030L</b>	<b>BCC030P</b>	<b>BCC030C</b>
BCC M415-0000-1A-001-PX0334-050	BCC M415-0000-1A-002-PX0334-050	BCC M415-0000-1A-004-PX0334-050
<b>BCC030M</b>	<b>BCC030R</b>	<b>BCC030E</b>
BCC M415-0000-1A-001-PX0334-100	BCC M415-0000-1A-002-PX0334-100	BCC M415-0000-1A-004-PX0334-100
<b>BCC030T</b>	<b>BCC030Y</b>	
BCC M415-0000-1A-036-PS0334-020	BCC M415-0000-1A-037-PS0334-020	
<b>BCC030U</b>	<b>BCC030Z</b>	
BCC M415-0000-1A-036-PS0334-050	BCC M415-0000-1A-037-PS0334-050	
<b>BCC030W</b>	<b>BCC0310</b>	
BCC M415-0000-1A-036-PS0334-100	BCC M415-0000-1A-037-PS0334-100	
<b>BCC034A</b>	<b>BCC034F</b>	<b>BCC0344</b>
BCC M415-0000-1A-001-VX8334-020	BCC M415-0000-1A-002-VX8334-020	BCC M415-0000-1A-004-VX8334-020
<b>BCC034C</b>	<b>BCC034H</b>	<b>BCC0345</b>
BCC M415-0000-1A-001-VX8334-050	BCC M415-0000-1A-002-VX8334-050	BCC M415-0000-1A-004-VX8334-050
<b>BCC034E</b>	<b>BCC034J</b>	<b>BCC0346</b>
BCC M415-0000-1A-001-VX8334-100	BCC M415-0000-1A-002-VX8334-100	BCC M415-0000-1A-004-VX8334-100
<b>BCC034K</b>	<b>BCC034N</b>	
BCC M415-0000-1A-036-VS8334-020	BCC M415-0000-1A-037-VS8334-020	
<b>BCC034L</b>	<b>BCC034P</b>	
BCC M415-0000-1A-036-VS8334-050	BCC M415-0000-1A-037-VS8334-050	
<b>BCC034M</b>	<b>BCC034R</b>	
BCC M415-0000-1A-036-VS8334-100	BCC M415-0000-1A-037-VS8334-100	

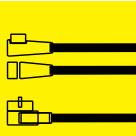

Connectors and cables  
Connectors M5  
Connection cables M5↔M8  
Connectors M8  
Connection cables M8↔M8  
Connection cables M8↔M12  
**Connectors M12**  
Connection cables M12↔M8  
Connection cables M12↔M12  
Tees, adapters  
Y-connectors  
Accessories  
Special properties

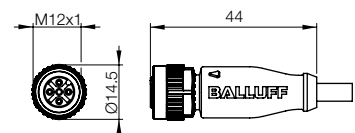
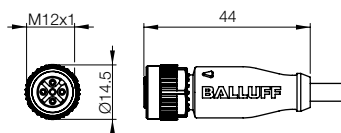
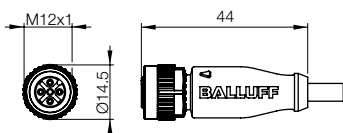

## M12 female straight and right-angle, 3-pin, without and with LED



Connector diagram and wiring	<p>PIN 1: brown PIN 2: black PIN 3: blue</p> <p><sup>1</sup> Green LED = Power <sup>2</sup> Yellow LED = Switching output</p>	<p>PIN 1: brown PIN 3: blue PIN 4: black</p> <p>Shield to knurl</p>
Max. supply voltage AC $U_B$	30 V DC	250 V AC
Max. supply voltage DC $U_B$	30 V DC	250 V DC
Cable	Molded	Molded
Number of conductors × conductor cross-section	3×0.34 mm <sup>2</sup>	3×0.34 mm <sup>2</sup>
Degree of protection as per IEC 60529	IP 68	IP 68
Ambient temperature $T_a$	PUR -40...+90 °C/-25...+90 °C (UL 80° C)	-40...+90 °C/-25...+90 °C (UL 80° C)
Static/moving	PUR shielded PVC -40...+105 °C/-5...+105 °C (UL 80 °C)	-40...+80 °C/-25...+80 °C -40...+105 °C/-5...+105 °C (UL 80 °C)
Use	PNP normally closed (NC)	Normally open (NO)
LED	Green/yellow	

Cable material	Color	Length	Ordering code
PUR	Black	2 m	<b>BCC030F</b> BCC M415-0000-1A-005-PX0334-020
PUR	Black	5 m	<b>BCC030H</b> BCC M415-0000-1A-005-PX0334-050
PUR	Black	10 m	<b>BCC030J</b> BCC M415-0000-1A-005-PX0334-100
PUR shielded	Black	2 m	<b>BCC031F</b> BCC M425-0000-1A-036-PS0334-020
PUR shielded	Black	5 m	<b>BCC031H</b> BCC M425-0000-1A-036-PS0334-050
PUR shielded	Black	10 m	<b>BCC031J</b> BCC M425-0000-1A-036-PS0334-100
PVC	Gray	2 m	<b>BCC0347</b> BCC M415-0000-1A-005-VX8334-020
PVC	Gray	5 m	<b>BCC0348</b> BCC M415-0000-1A-005-VX8334-050
PVC	Gray	10 m	<b>BCC0349</b> BCC M415-0000-1A-005-VX8334-100
PVC shielded	Gray	2 m	<b>BCC0357</b> BCC M425-0000-1A-036-VS8334-020
PVC shielded	Gray	5 m	<b>BCC0358</b> BCC M425-0000-1A-036-VS8334-050
PVC shielded	Gray	10 m	<b>BCC0359</b> BCC M425-0000-1A-036-VS8334-100

Other cable materials, colors, and lengths on request.  
Connectors without LED are suitable for PNP and NPN switching functions.  
NPN versions on request.

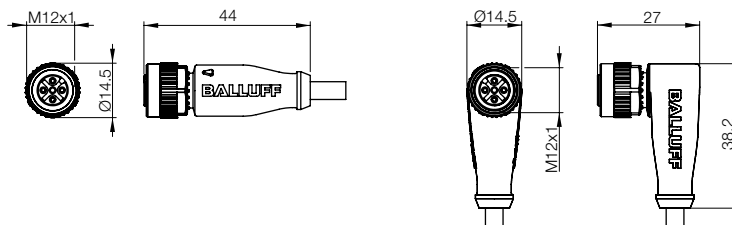

# Connectors

## M12 female right-angle, 3-pin, without and with LED

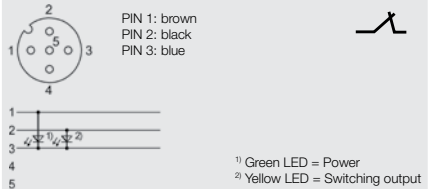
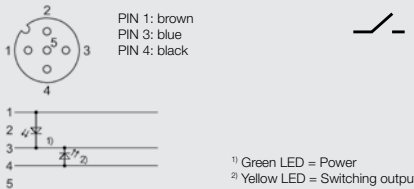
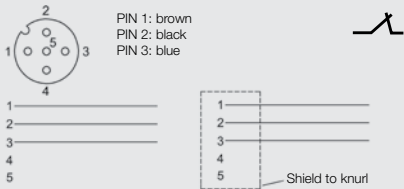

250 V AC 250 V DC Molded 3×0.34 mm <sup>2</sup> IP 68 -40...+90 °C/-25...+90 °C (UL 80° C) -40...+80 °C/-25...+80 °C -40...+105 °C/-5...+105 °C (UL 80 °C) -20...+105 °C (UL 80 °C) Normally closed (NC)	30 V DC Molded 3×0.34 mm <sup>2</sup> IP 68 -40...+90 °C/-25...+90 °C (UL 80° C) -40...+105 °C/-5...+105 °C (UL 80 °C) PNP normally open (NO) Green/yellow	30 V DC Molded 3×0.34 mm <sup>2</sup> IP 68 -40...+90 °C/-25...+90 °C (UL 80° C) -40...+105 °C/-5...+105 °C (UL 80 °C) PNP normally closed (NC) Green/yellow
---	---	---

### Ordering code

Part number

BCC031A	BCC0311	BCC0314
BCC M425-0000-1A-002-PX0334-020	BCC M425-0000-1A-004-PX0334-020	BCC M425-0000-1A-005-PX0334-020
<b>BCC031C</b>	<b>BCC0312</b>	<b>BCC0315</b>
BCC M425-0000-1A-002-PX0334-050	BCC M425-0000-1A-004-PX0334-050	BCC M425-0000-1A-005-PX0334-050
<b>BCC031E</b>	<b>BCC0313</b>	<b>BCC0316</b>
BCC M425-0000-1A-002-PX0334-100	BCC M425-0000-1A-004-PX0334-100	BCC M425-0000-1A-005-PX0334-100
<b>BCC031K</b>		
BCC M425-0000-1A-037-PS0334-020		
<b>BCC031L</b>		
BCC M425-0000-1A-037-PS0334-050		
<b>BCC031M</b>		
BCC M425-0000-1A-037-PS0334-100		
<b>BCC0354</b>	<b>BCC034T</b>	<b>BCC034Y</b>
BCC M425-0000-1A-002-VX8334-020	BCC M425-0000-1A-004-VX8334-020	BCC M425-0000-1A-005-VX8334-020
<b>BCC0355</b>	<b>BCC034U</b>	<b>BCC034Z</b>
BCC M425-0000-1A-002-VX8334-050	BCC M425-0000-1A-004-VX8334-050	BCC M425-0000-1A-005-VX8334-050
<b>BCC0356</b>	<b>BCC034W</b>	<b>BCC0350</b>
BCC M425-0000-1A-002-VX8334-100	BCC M425-0000-1A-004-VX8334-100	BCC M425-0000-1A-005-VX8334-100
<b>BCC035A</b>		
BCC M425-0000-1A-037-VS8334-020		
<b>BCC035C</b>		
BCC M425-0000-1A-037-VS8334-050		
<b>BCC035E</b>		
BCC M425-0000-1A-037-VS8334-100		

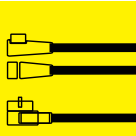

Connectors and cables  
Connectors M5  
Connection cables M5↔M8  
Connectors M8  
Connection cables M8↔M8  
Connection cables M8↔M12  
**Connectors M12**  
Connection cables M12↔M8  
Connection cables M12↔M12  
Tees, adapters  
Y-connectors  
Accessories  
Special properties

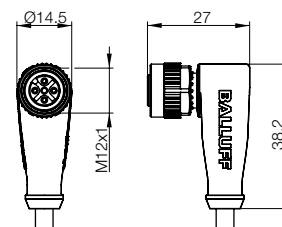
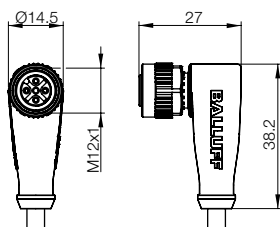
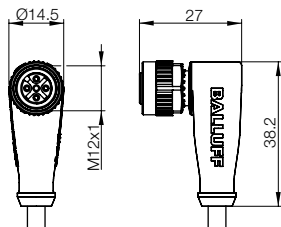

## M12 male, straight 4-pin and 5-pin, without LED



Connector diagram and wiring		
Max. supply voltage AC $U_B$	250 V AC	125 V AC
Max. supply voltage DC $U_B$	250 V DC	125 V DC
Cable	Molded	Molded
Number of conductors × conductor cross-section	4×0.34 mm <sup>2</sup>	5×0.34 mm <sup>2</sup>
Degree of protection as per IEC 60529	IP 68	IP 68
Ambient temperature $T_a$	PUR -40...+90 °C/-25...+90 °C (UL 80° C)	-40...+90 °C/-25...+90 °C (UL 80° C)
Static/moving	PUR shielded -40...+80 °C/-25...+80 °C	-40...+80 °C/-25...+80 °C
	PVC -40...+105 °C/-5...+105 °C (UL 80 °C)	-40...+105 °C/-5...+105 °C (UL 80 °C)
	PVC shielded -20...+105 °C (UL 80 °C)	-20...+105 °C (UL 80 °C)
Use LED	Complementary (NO/NC) ✓ - / ✗	Complementary (NO/NC) ✓ - / ✗

Cable material	Color	Length	Ordering code	
			Part number	
PUR	Black	2 m	<b>BCC031N</b>	<b>BCC0C76</b>
			BCC M414-0000-2A-003-PX0434-020	BCC M415-0000-2A-017-PX0534-020
PUR	Black	5 m	<b>BCC031P</b>	<b>BCC0C77</b>
			BCC M414-0000-2A-003-PX0434-050	BCC M415-0000-2A-017-PX0534-050
PUR	Black	10 m	<b>BCC031R</b>	<b>BCC0C78</b>
			BCC M414-0000-2A-003-PX0434-100	BCC M415-0000-2A-017-PX0534-100
PUR shielded	Black	2 m	<b>BCC031T</b>	<b>BCC08JE</b>
			BCC M414-0000-2A-014-PS0434-020	BCC M415-0000-2A-034-PX0534-020
PUR shielded	Black	5 m	<b>BCC031U</b>	<b>BCC08JC</b>
			BCC M414-0000-2A-014-PS0434-050	BCC M415-0000-2A-034-PX0534-050
PUR shielded	Black	10 m	<b>BCC031W</b>	<b>BCC0JA</b>
			BCC M414-0000-2A-014-PS0434-100	BCC M415-0000-2A-034-PX0534-100
PVC	Gray	2 m	<b>BCC035F</b>	<b>BCC0AU3</b>
			BCC M414-0000-2A-003-VX8434-020	BCC M415-0000-2A-017-VX8534-020
PVC	Gray	5 m	<b>BCC035H</b>	<b>BCC0AT6</b>
			BCC M414-0000-2A-003-VX8434-050	BCC M415-0000-2A-017-VX8534-050
PVC	Gray	10 m	<b>BCC035J</b>	<b>BCC0AUK</b>
			BCC M414-0000-2A-003-VX8434-100	BCC M415-0000-2A-017-VX8534-100
PVC shielded	Gray	2 m	<b>BCC035K</b>	
			BCC M414-0000-2A-014-VS8434-020	
PVC shielded	Gray	5 m	<b>BCC035L</b>	
			BCC M414-0000-2A-014-VS8434-050	
PVC shielded	Gray	10 m	<b>BCC035M</b>	
			BCC M414-0000-2A-014-VS8434-100	

Other cable materials, colors, and lengths on request.  
Connectors without LED are suitable for PNP and NPN switching functions.  
NPN versions on request.

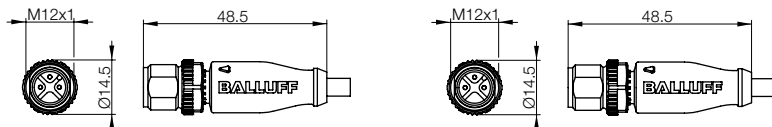



# Connectors

## M12 female straight, 4-pin, with and without LED

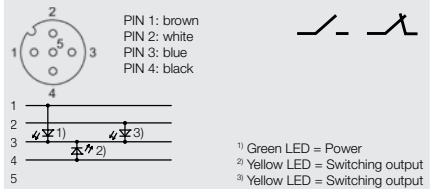
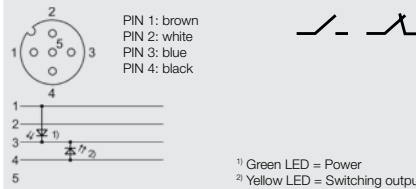
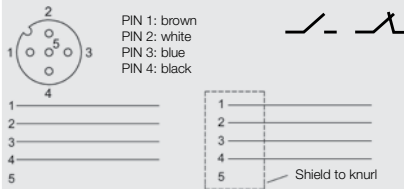

250 V AC 250 V DC Molded 4x0.34 mm <sup>2</sup> IP 68 -40...+90 °C/-25...+90 °C (UL 80° C) -40...+80 °C/-25...+80 °C -40...+105 °C/-5...+105 °C (UL 80 °C) -20...+105 °C (UL 80 °C) Complementary (NO/NC)	30 V DC Molded 4x0.34 mm <sup>2</sup> IP 68 -40...+90 °C/-25...+90 °C (UL 80° C) -40...+105 °C/-5...+105 °C (UL 80 °C) PNP complementary (NO/NC)	30 V DC Molded 4x0.34 mm <sup>2</sup> IP 68 -40...+90 °C/-25...+90 °C (UL 80° C) -40...+105 °C/-5...+105 °C (UL 80 °C) PNP complementary (NO/NC)
--	--	--

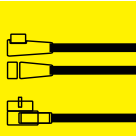

Ordering code		
Part number		
<b>BCC032F</b> BCC M415-0000-1A-003-PX0434-020	<b>BCC0327</b> BCC M415-0000-1A-008-PX0434-020	<b>BCC032A</b> BCC M415-0000-1A-010-PX0434-020
<b>BCC032H</b> BCC M415-0000-1A-003-PX0434-050	<b>BCC0328</b> BCC M415-0000-1A-008-PX0434-050	<b>BCC032C</b> BCC M415-0000-1A-010-PX0434-050
<b>BCC032J</b> BCC M415-0000-1A-003-PX0434-100	<b>BCC0329</b> BCC M415-0000-1A-008-PX0434-100	<b>BCC032E</b> BCC M415-0000-1A-010-PX0434-100
<b>BCC032K</b> BCC M415-0000-1A-014-PS0434-020		
<b>BCC032L</b> BCC M415-0000-1A-014-PS0434-050		
<b>BCC032M</b> BCC M415-0000-1A-014-PS0434-100		
<b>BCC0367</b> BCC M415-0000-1A-003-VX8434-020	<b>BCC0361</b> BCC M415-0000-1A-008-VX8434-020	<b>BCC0364</b> BCC M415-0000-1A-010-VX8434-020
<b>BCC0368</b> BCC M415-0000-1A-003-VX8434-050	<b>BCC0362</b> BCC M415-0000-1A-008-VX8434-050	<b>BCC0365</b> BCC M415-0000-1A-010-VX8434-050
<b>BCC0369</b> BCC M415-0000-1A-003-VX8434-100	<b>BCC0363</b> BCC M415-0000-1A-008-VX8434-100	<b>BCC0366</b> BCC M415-0000-1A-010-VX8434-100
<b>BCC036A</b> BCC M415-0000-1A-014-VS8434-020		
<b>BCC036C</b> BCC M415-0000-1A-014-VS8434-050		
<b>BCC036E</b> BCC M415-0000-1A-014-VS8434-100		



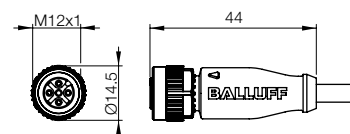
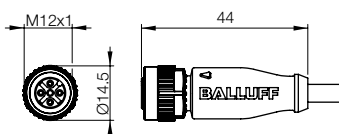
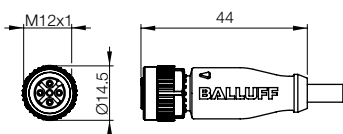



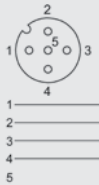
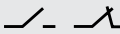
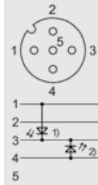
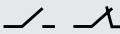





Connectors and cables  
Connectors M5  
Connection cables M5↔M8  
Connectors M8  
Connection cables M8↔M8  
Connection cables M8↔M12  
Connectors M12  
Connection cables M12↔M8  
Connection cables M12↔M12  
Tees, adapters  
Y-connectors  
Accessories  
Special properties





Connector diagram and wiring	 <p>PIN 1: brown PIN 2: white PIN 3: blue PIN 4: black</p>		 <p>PIN 1: brown PIN 2: white PIN 3: blue PIN 4: black</p>	 <p><sup>1</sup> Green LED = Power <sup>2</sup> Yellow LED = Switching output</p>
Max. supply voltage AC $U_B$	250 V AC		30 V DC	
Max. supply voltage DC $U_B$	250 V DC			
Cable	Molded		Molded	
Number of conductors × conductor cross-section	4×0.34 mm <sup>2</sup>		4×0.34 mm <sup>2</sup>	
Degree of protection as per IEC 60529	IP 68		IP 68	
Ambient temperature $T_a$	PUR -40...+90 °C/-25...+90 °C (UL 80° C)		PUR -40...+90 °C/-25...+90 °C (UL 80° C)	
Static/moving	PUR shielded -40...+80 °C/-25...+80 °C		PUR shielded -40...+80 °C/-25...+80 °C	
	PVC -40...+105 °C/-5...+105 °C (UL 80 °C)		PVC -40...+105 °C/-5...+105 °C (UL 80 °C)	
	PVC shielded -20...+105 °C (UL 80 °C)		PVC shielded -20...+105 °C (UL 80 °C)	
Use	Complementary (NO/NC) 		PNP complementary (NO/NC) 	
LED			Green/yellow	

Cable material	Color	Length	Ordering code		
			Part number		
PUR		Black	2 m	<b>BCC032Y</b> BCC M425-0000-1A-003-PX0434-020	<b>BCC032N</b> BCC M425-0000-1A-008-PX0434-020
			5 m	<b>BCC032Z</b> BCC M425-0000-1A-003-PX0434-050	<b>BCC032P</b> BCC M425-0000-1A-008-PX0434-050
PUR		Black	10 m	<b>BCC0330</b> BCC M425-0000-1A-003-PX0434-100	<b>BCC032R</b> BCC M425-0000-1A-008-PX0434-100
PUR shielded		Black	2 m	<b>BCC0331</b> BCC M425-0000-1A-014-PS0434-020	
PUR shielded		Black	5 m	<b>BCC0332</b> BCC M425-0000-1A-014-PS0434-050	
PUR shielded		Black	10 m	<b>BCC0333</b> BCC M425-0000-1A-014-PS0434-100	
PVC		Gray	2 m	<b>BCC036N</b> BCC M425-0000-1A-003-VX8434-020	<b>BCC036F</b> BCC M425-0000-1A-008-VX8434-020
			5 m	<b>BCC036P</b> BCC M425-0000-1A-003-VX8434-050	<b>BCC036H</b> BCC M425-0000-1A-008-VX8434-050
PVC		Gray	10 m	<b>BCC036R</b> BCC M425-0000-1A-003-VX8434-100	<b>BCC036J</b> BCC M425-0000-1A-008-VX8434-100
PVC shielded		Gray	2 m	<b>BCC036T</b> BCC M425-0000-1A-014-VS8434-020	
PVC shielded		Gray	5 m	<b>BCC036U</b> BCC M425-0000-1A-014-VS8434-050	
PVC shielded		Gray	10 m	<b>BCC036W</b> BCC M425-0000-1A-014-VS8434-100	

Other cable materials, colors, and lengths on request.

Connectors without LED are suitable for PNP and NPN switching functions. NPN versions on request.

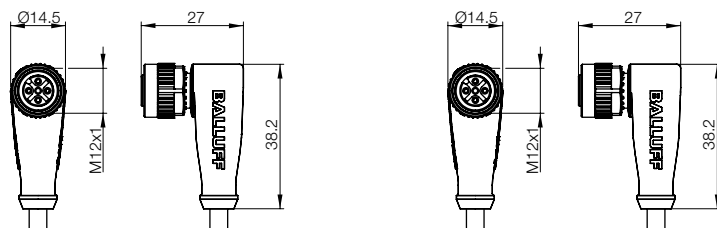

# Connectors

## M12 female right-angle, 4-pin, with LED

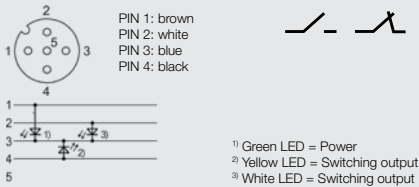

30 V DC  
Molded  
4x0.34 mm<sup>2</sup>  
IP 68  
-40...+90 °C/-25...+90 °C (UL 80° C)  
-40...+105 °C/-5...+105 °C (UL 80 °C)  
PNP complementary (NO/NC)   
Green/yellow/white

### Ordering code

Part number

#### BCC032T

BCC M425-0000-1A-010-PX0434-020

#### BCC032U

BCC M425-0000-1A-010-PX0434-050

#### BCC032W

BCC M425-0000-1A-010-PX0434-100

#### BCC036K

BCC M425-0000-1A-010-VX8434-020

#### BCC036L

BCC M425-0000-1A-010-VX8434-050

#### BCC036M

BCC M425-0000-1A-010-VX8434-100

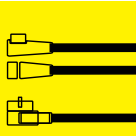

Connectors and cables

Connectors M5

Connection cables M5↔M8

Connectors M8

Connection cables M8↔M8

Connection cables M8↔M12

### Connectors M12

Connection cables M12↔M8

Connection cables M12↔M12

Tees, adapters

Y-connectors

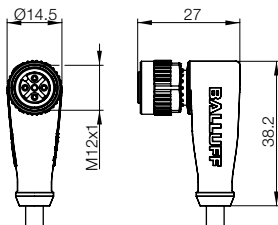

Accessories

Special properties



## M12 female straight and right-angle, 5-pin, no LED



Connector diagram and wiring	 PIN 1: brown PIN 2: white PIN 3: blue PIN 4: black PIN 5: gray or green/yellow	 PIN 1: brown PIN 2: white PIN 3: blue PIN 4: black PIN 5: gray or green/yellow
Max. supply voltage AC $U_B$	125 V AC	125 V AC
Max. supply voltage DC $U_B$	125 V DC	125 V DC
Cable	Molded	Molded
Number of conductors × conductor cross-section	5×0.34 mm <sup>2</sup>	5×0.34 mm <sup>2</sup>
Degree of protection as per IEC 60529	IP 68	IP 68
Ambient temperature $T_a$	–40...+90 °C/–25...+90 °C (UL 80° C)	–40...+90 °C/–25...+90 °C (UL 80° C)
Static/moving	PUR	PVC
Use	–40...+105 °C/–5...+105 °C (UL 80 °C)	–40...+105 °C/–5...+105 °C (UL 80 °C)
LED	Complementary (NO/NC) $\checkmark$ –/– $\checkmark$	Complementary (NO/NC) $\checkmark$ –/– $\checkmark$

Cable material	Color	Length	Ordering code	
			Part number	
PUR	Black	2 m	<b>BCC08FE</b>	<b>BCC09H7</b>
Pin 5 gray			BCC M415-0000-1A-017-PX0534-020	BCC M425-0000-1A-017-PX0534-020
PUR	Black	5 m	<b>BCC098C</b>	<b>BCC08FC</b>
Pin 5 gray			BCC M415-0000-1A-017-PX0534-050	BCC M425-0000-1A-017-PX0534-050
PUR	Black	10 m	<b>BCC0860</b>	<b>BCC08FA</b>
Pin 5 gray			BCC M415-0000-1A-017-PX0534-100	BCC M425-0000-1A-017-PX0534-100
PUR	Black	2 m	<b>BCC09H4</b>	<b>BCC08F9</b>
Pin 5 green/gray			BCC M415-0000-1A-034-PX0534-020	BCC M425-0000-1A-034-PX0534-020
PUR	Black	5 m	<b>BCC09H5</b>	<b>BCC08F8</b>
Pin 5 green/gray			BCC M415-0000-1A-034-PX0534-050	BCC M425-0000-1A-034-PX0534-050
PUR	Black	10 m	<b>BCC09H6</b>	<b>BCC08F7</b>
Pin 5 green/gray			BCC M415-0000-1A-034-PX0534-100	BCC M425-0000-1A-034-PX0534-100
PVC	Gray	5 m	<b>BCC0AT5</b>	
Pin 5 gray			BCC M415-0000-1A-017-VX8534-050	
PVC	Gray	10 m	<b>BCC0AN9</b>	
Pin 5 gray			BCC M415-0000-1A-017-VX8534-100	

Other cable materials, colors, and lengths on request.  
 Connectors without LED are suitable for PNP and NPN switching functions.  
 NPN versions on request.

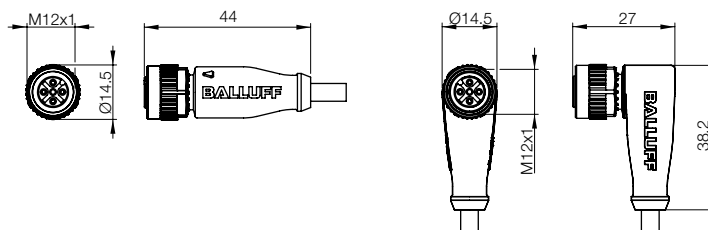

# Connectors

## M12 female right-angle, 5-pin, with LED



PIN 1: brown  
 PIN 2: white  
 PIN 3: blue  
 PIN 4: black  
 PIN 5: gray or green/yellow

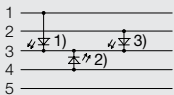

<sup>1)</sup> Green LED = Power  
<sup>2)</sup> Yellow LED = Switching output  
<sup>3)</sup> White LED = Switching output

30 V DC  
 Molded  
 5×0.34 mm<sup>2</sup>  
 IP 68  
 -40...+90 °C/-25...+90 °C (UL 80° C)  
 -40...+105 °C/-5...+105 °C (UL 80 °C)  
 PNP complementary (NO/NC)  $\sim$ / $\sim$ / $\sim$   
 Green/yellow/white

### Ordering code

Part number

#### BCC08F6

BCC M425-0000-1A-039-PX0534-020

#### BCC08F5

BCC M425-0000-1A-039-PX0534-050

#### BCC08F4

BCC M425-0000-1A-039-PX0534-100

#### BCC08HP

BCC M425-0000-1A-040-PX0534-020

#### BCC08HR

BCC M425-0000-1A-040-PX0534-050

#### BCC08HT

BCC M425-0000-1A-040-PX0534-100

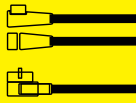

Connectors and cables

Connectors M5

Connection cables M5↔M8

Connectors M8

Connection cables M8↔M8

Connection cables M8↔M12

### Connectors M12

Connection cables M12↔M8

Connection cables M12↔M12

Tees, adapters

Y-connectors

Accessories

Special properties

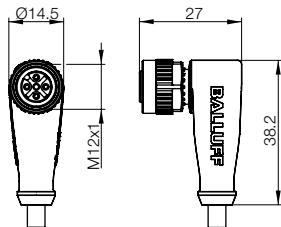

# Connectors

## M12 female straight, 8-pin, no LED

# M12



Connector diagram and wiring		1 _____ WH 2 _____ GN 3 _____ YE 4 _____ GY 5 _____ BN 6 _____ PK 7 _____ BU 8 _____ RD		1 _____ WH 2 _____ BN 3 _____ GN 4 _____ YE 5 _____ GY 6 _____ PK 7 _____ BU 8 _____ RD
	Max. supply voltage AC $U_B$	60 V AC	60 V AC	
Max. supply voltage DC $U_B$	60 V DC	60 V DC		
Cable	Molded	Molded		
Number of conductors × conductor cross-section	8×0.25 mm <sup>2</sup>	8×0.25 mm <sup>2</sup>		
Degree of protection as per IEC 60529	IP 68	IP 68		
Ambient temperature $T_a$	PUR -40...+80 °C/-25...+80 °C	PUR -40...+80 °C/-25...+80 °C		
Static/moving	PUR shielded -40...+80 °C/-25...+80 °C	PUR shielded -40...+80 °C/-25...+80 °C		

Cable material	Color	Length	Ordering code		
			Part number		
PUR		Black	2 m	<b>BCC06K1</b>	<b>BCC09J3</b>
				BCC M418-0000-1A-044-PX0825-020	BCC M418-0000-1A-069-PX0825-020
PUR		Black	5 m	<b>BCC06K2</b>	<b>BCC09J4</b>
				BCC M418-0000-1A-044-PX0825-050	BCC M418-0000-1A-069-PX0825-050
PUR		Black	10 m	<b>BCC06K3</b>	<b>BCC085Z</b>
				BCC M418-0000-1A-044-PX0825-100	BCC M418-0000-1A-069-PX0825-100
PUR shielded		Black	2 m		<b>BCC0994</b>
					BCC M418-0000-1A-046-PS0825-020
PUR shielded		Black	5 m		<b>BCC0995</b>
					BCC M418-0000-1A-046-PS0825-050
PUR shielded		Black	10 m		<b>BCC0996</b>
					BCC M418-0000-1A-046-PS0825-100

Other cable materials, colors, and lengths on request.  
 Connectors without LED are suitable for PNP and NPN switching functions.  
 NPN versions on request.

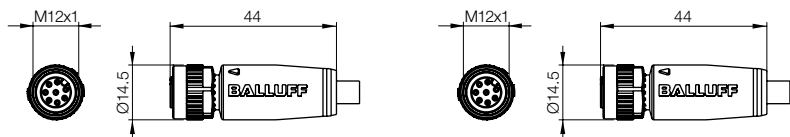

# Connectors

## M12 female straight and right-angle, 8-pin, no LED



1	BN
2	WS
3	BU
4	BK
5	GY
6	PK
7	VT
8	OR



1	WH
2	GN
3	YE
4	GY
5	BN
6	PK
7	BU
8	RD



1	BN
2	WS
3	BU
4	BK
5	GY
6	PK
7	VT
8	OR

60 V AC

60 V DC

Molded

8x0.25 mm<sup>2</sup>

IP 68

-40...+80 °C/-25...+80 °C

-40...+80 °C/-25...+80 °C

60 V AC

60 V DC

Molded

8x0.25 mm<sup>2</sup>

IP 68

-40...+80 °C/-25...+80 °C

-40...+80 °C/-25...+80 °C

60 V AC

60 V DC

Molded

8x0.25 mm<sup>2</sup>

IP 68

-40...+80 °C/-25...+80 °C

-40...+80 °C/-25...+80 °C

### Ordering code

Part number

#### BCC09HC

BCC M418-0000-1A-045-PX0825-020

#### BCC09HE

BCC M418-0000-1A-045-PX0825-050

#### BCC09HF

BCC M418-0000-1A-045-PX0825-100

#### BCC06K4

BCC M428-0000-1A-044-PX0825-020

#### BCC06K5

BCC M428-0000-1A-044-PX0825-050

#### BCC06K6

BCC M428-0000-1A-044-PX0825-100

#### BCC0997

BCC M428-0000-1A-046-PS0825-020

#### BCC0998

BCC M428-0000-1A-046-PS0825-050

#### BCC0999

BCC M428-0000-1A-046-PS0825-100

#### BCC09H8

BCC M428-0000-1A-045-PX0825-020

#### BCC09H9

BCC M428-0000-1A-045-PX0825-050

#### BCC09HA

BCC M428-0000-1A-045-PX0825-100

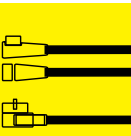

Connectors and cables

Connectors M5

Connection cables M5↔M8

Connectors M8

Connection cables M8↔M8

Connection cables M8↔M12

### Connectors M12

Connection cables M12↔M8

Connection cables M12↔M12

Tees, adapters

Y-connectors

Accessories

Special properties

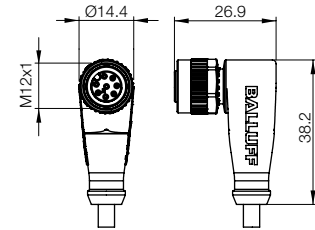
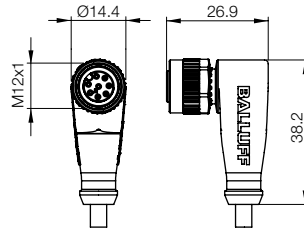
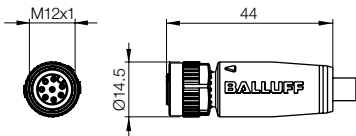



View of female/ Plug side	<ul style="list-style-type: none"> <li>1 ————— BN</li> <li>2 ————— BU</li> <li>3 ————— WH</li> <li>4 ————— GN</li> <li>5 ————— PK</li> <li>6 ————— YE</li> <li>7 ————— BK</li> <li>8 ————— GY</li> <li>9 ————— RD</li> <li>10 ————— VT</li> <li>11 ————— GY/PK</li> <li>12 ————— RD/BU</li> </ul>	<ul style="list-style-type: none"> <li>1 ————— BN</li> <li>2 ————— BU</li> <li>3 ————— WH</li> <li>4 ————— GN</li> <li>5 ————— PK</li> <li>6 ————— YE</li> <li>7 ————— BK</li> <li>8 ————— GY</li> <li>9 ————— RD</li> <li>10 ————— VT</li> <li>11 ————— GY/PK</li> <li>12 ————— RD/BU</li> </ul>
Max. supply voltage AC $U_B$	30 V DC	30 V DC
Max. supply voltage DC $U_B$	30 V DC	30 V DC
Cable	Molded	Molded
Number of conductors × conductor cross-section	12×0.25 mm <sup>2</sup>	12×0.25 mm <sup>2</sup>
Degree of protection as per IEC 60529	IP 68	IP 68
Ambient temperature $T_a$	PUR -40...+90 °C/-25...+90 °C (UL 80 °C)	-40...+90 °C/-25...+90 °C (UL 80 °C)
Static/moving	PVC -40...+105 °C/-5...+105 °C (UL 80 °C)	-40...+105 °C/-5...+105 °C (UL 80 °C)
Use	BIC0009 Base	BIC000A Remote

Cable material	Color	Length	Ordering code		
			Part number		
PUR		Black	2 m	<b>BCC06UK</b>	<b>BCC06UU</b>
				BCC M41C-0000-1A-049-PX0C25-020	BCC M41C-0000-2A-049-PX0C25-020
PUR		Black	5 m	<b>BCC06UL</b>	<b>BCC06UW</b>
				BCC M41C-0000-1A-049-PX0C25-050	BCC M41C-0000-2A-049-PX0C25-050
PUR		Black	10 m	<b>BCC06UM</b>	<b>BCC06UY</b>
				BCC M41C-0000-1A-049-PX0C25-100	BCC M41C-0000-2A-049-PX0C25-100
PVC		Gray	2 m	<b>BCC06UP</b>	<b>BCC06UZ</b>
				BCC M41C-0000-1A-049-VX8C25-020	BCC M41C-0000-2A-049-VX8C25-020
PVC		Gray	5 m	<b>BCC06UR</b>	<b>BCC06W0</b>
				BCC M41C-0000-1A-049-VX8C25-050	BCC M41C-0000-2A-049-VX8C25-050
PVC		Gray	10 m	<b>BCC06UT</b>	<b>BCC06W1</b>
				BCC M41C-0000-1A-049-VX8C25-100	BCC M41C-0000-2A-049-VX8C25-100

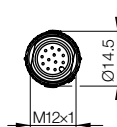
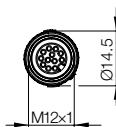
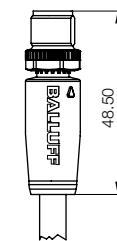
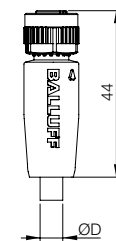



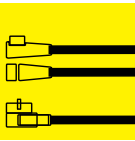

Connectors  
and cables

Connectors  
M5

Connection  
cables  
M5↔M8

Connectors  
M8

Connection  
cables  
M8↔M8

Connection  
cables  
M8↔M12

**Connectors M12**

Connection  
cables  
M12↔M8

Connection  
cables  
M12↔M12

Tees,  
adapters

Y-connectors

Accessories

Special  
properties

# Connection Cables

**M12 female straight or right-angle ↔ M8 male straight, 3-pin, without LED**

M12 ↔ M8



Connector diagram and wiring		
Max. supply voltage AC $U_B$	60 V AC	60 V AC
Max. supply voltage DC $U_B$	60 V DC	60 V DC
Cable	Molded	Molded
Number of conductors × conductor cross-section	3×0.34 mm <sup>2</sup>	3×0.34 mm <sup>2</sup>
Degree of protection as per IEC 60529	IP 67	IP 67
Ambient temperature $T_a$	PUR -25...+90 °C/-25...+90 °C (UL 80 °C)	PUR -25...+90 °C/-25...+90 °C (UL 80 °C)
Static/moving	PVC -5...+105 °C/-5...+90 °C (UL 80 °C)	PVC -5...+105 °C/-5...+90 °C (UL 80 °C)
Use	Normally open (NO) ✓-	Normally open (NO) ✓-
LED		

Cable material	Color	Length	Ordering code	
			Part number	
PUR	Black	0.3 m	<b>BCC03M9</b> BCC M415-M313-3F-300-PX0334-003	<b>BCC03MU</b> BCC M425-M313-3F-300-PX0334-003
PUR	Black	0.6 m	<b>BCC03MA</b> BCC M415-M313-3F-300-PX0334-006	<b>BCC03MW</b> BCC M425-M313-3F-300-PX0334-006
PUR	Black	1 m	<b>BCC03MC</b> BCC M415-M313-3F-300-PX0334-010	<b>BCC03MY</b> BCC M425-M313-3F-300-PX0334-010
PUR	Black	1.5 m	<b>BCC03ME</b> BCC M415-M313-3F-300-PX0334-015	<b>BCC03MZ</b> BCC M425-M313-3F-300-PX0334-015
PUR	Black	2 m	<b>BCC03MF</b> BCC M415-M313-3F-300-PX0334-020	<b>BCC03N0</b> BCC M425-M313-3F-300-PX0334-020
PUR	Black	3 m	<b>BCC03MH</b> BCC M415-M313-3F-300-PX0334-030	<b>BCC03N1</b> BCC M425-M313-3F-300-PX0334-030
PUR	Black	5 m	<b>BCC03MJ</b> BCC M415-M313-3F-300-PX0334-050	<b>BCC03N2</b> BCC M425-M313-3F-300-PX0334-050
PVC	Gray	0.3 m	<b>BCC03NW</b> BCC M415-M313-3F-300-VX8334-003	<b>BCC03PC</b> BCC M425-M313-3F-300-VX8334-003
PVC	Gray	0.6 m	<b>BCC03NY</b> BCC M415-M313-3F-300-VX8334-006	<b>BCC03PE</b> BCC M425-M313-3F-300-VX8334-006
PVC	Gray	1 m	<b>BCC03NZ</b> BCC M415-M313-3F-300-VX8334-010	<b>BCC03PF</b> BCC M425-M313-3F-300-VX8334-010
PVC	Gray	1.5 m	<b>BCC03P0</b> BCC M415-M313-3F-300-VX8334-015	<b>BCC03PH</b> BCC M425-M313-3F-300-VX8334-015
PVC	Gray	2 m	<b>BCC03P1</b> BCC M415-M313-3F-300-VX8334-020	<b>BCC03PJ</b> BCC M425-M313-3F-300-VX8334-020
PVC	Gray	3 m	<b>BCC03P2</b> BCC M415-M313-3F-300-VX8334-030	<b>BCC03PK</b> BCC M425-M313-3F-300-VX8334-030
PVC	Gray	5 m	<b>BCC03P3</b> BCC M415-M313-3F-300-VX8334-050	<b>BCC03PL</b> BCC M425-M313-3F-300-VX8334-050

Other cable materials, colors, and lengths on request.  
Connectors without LED are suitable for PNP and NPN switching functions.  
NPN versions on request.

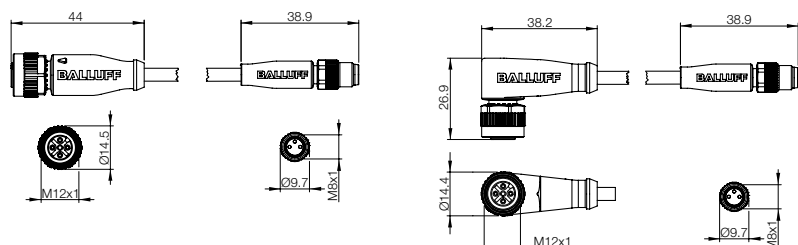

# Connection Cables

## M12 female right-angle ↔ M8 male straight, 3-pin, with LED

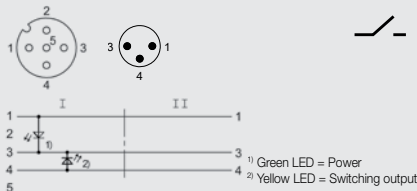

30 V DC  
 Molded  
 3×0.34 mm<sup>2</sup>  
 IP 67  
 -25...+90 °C/-25...+90 °C (UL 80 °C)  
 -5...+105 °C/-5...+90 °C (UL 80 °C)  
 PNP normally open (NO) ✓-  
 Green/yellow

### Ordering code

Part number

<b>BCC03NA</b>	BCC M425-M313-3F-602-PX0334-003
<b>BCC03NC</b>	BCC M425-M313-3F-602-PX0334-006
<b>BCC03NE</b>	BCC M425-M313-3F-602-PX0334-010
<b>BCC03NF</b>	BCC M425-M313-3F-602-PX0334-015
<b>BCC03NH</b>	BCC M425-M313-3F-602-PX0334-020
<b>BCC03NJ</b>	BCC M425-M313-3F-602-PX0334-030
<b>BCC03NK</b>	BCC M425-M313-3F-602-PX0334-050
<b>BCC03PY</b>	BCC M425-M313-3F-602-VX8334-003
<b>BCC03PZ</b>	BCC M425-M313-3F-602-VX8334-006
<b>BCC03R0</b>	BCC M425-M313-3F-602-VX8334-010
<b>BCC03R1</b>	BCC M425-M313-3F-602-VX8334-015
<b>BCC03R2</b>	BCC M425-M313-3F-602-VX8334-020
<b>BCC03R3</b>	BCC M425-M313-3F-602-VX8334-030
<b>BCC03R4</b>	BCC M425-M313-3F-602-VX8334-050

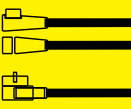

Connectors and cables  
 Connectors M5  
 Connection cables M5↔M8  
 Connectors M8  
 Connection cables M8↔M8  
 Connection cables M8↔M12  
 Connectors M12  
**Connection cables M12↔M8**  
 Connection cables M12↔M12  
 Tees, adapters  
 Y-connectors  
 Accessories  
 Special properties

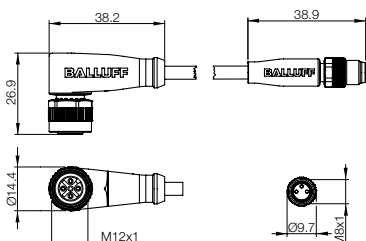



# Connection Cables

## M12 female straight or right-angle ↔ M8 male straight, 4-pin, without LED

M12 ↔ M8

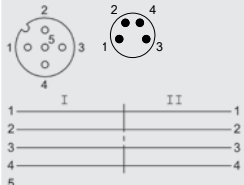
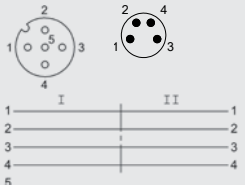

Connector diagram and wiring		
Max. supply voltage AC $U_B$	30 V AC	30 V AC
Max. supply voltage DC $U_B$	30 V DC	30 V DC
Cable	Molded	Molded
Number of conductors × conductor cross-section	4×0.34 mm <sup>2</sup>	4×0.34 mm <sup>2</sup>
Degree of protection as per IEC 60529	IP 67	IP 67
Ambient temperature $T_a$	-25...+90 °C / -25...+90 °C (UL 80 °C)	-25...+90 °C / -25...+90 °C (UL 80 °C)
Static/moving	PUR	PVC
Use	-5...+105 °C / -5...+90 °C (UL 80 °C)	-5...+105 °C / -5...+90 °C (UL 80 °C)
LED	Complementary (NO/NC) 	Complementary (NO/NC) 

Cable material	Color	Length	Ordering code	
			Part number	
PUR	Black	0.3 m	<b>BCC03RE</b> BCC M415-M314-3F-304-PX0434-003	<b>BCC03RZ</b> BCC M425-M314-3F-304-PX0434-003
PUR	Black	0.6 m	<b>BCC03RF</b> BCC M415-M314-3F-304-PX0434-006	<b>BCC03T0</b> BCC M425-M314-3F-304-PX0434-006
PUR	Black	1 m	<b>BCC03RH</b> BCC M415-M314-3F-304-PX0434-010	<b>BCC03T1</b> BCC M425-M314-3F-304-PX0434-010
PUR	Black	1.5 m	<b>BCC03RJ</b> BCC M415-M314-3F-304-PX0434-015	<b>BCC03T2</b> BCC M425-M314-3F-304-PX0434-015
PUR	Black	2 m	<b>BCC03RK</b> BCC M415-M314-3F-304-PX0434-020	<b>BCC03T3</b> BCC M425-M314-3F-304-PX0434-020
PUR	Black	3 m	<b>BCC03RL</b> BCC M415-M314-3F-304-PX0434-030	<b>BCC03T4</b> BCC M425-M314-3F-304-PX0434-030
PUR	Black	5 m	<b>BCC03RM</b> BCC M415-M314-3F-304-PX0434-050	<b>BCC03T5</b> BCC M425-M314-3F-304-PX0434-050
PVC	Gray	0.3 m	<b>BCC03TP</b> BCC M415-M314-3F-304-VX8434-003	<b>BCC03U7</b> BCC M425-M314-3F-304-VX8434-003
PVC	Gray	0.6 m	<b>BCC03TR</b> BCC M415-M314-3F-304-VX8434-006	<b>BCC03U8</b> BCC M425-M314-3F-304-VX8434-006
PVC	Gray	1 m	<b>BCC03TT</b> BCC M415-M314-3F-304-VX8434-010	<b>BCC03U9</b> BCC M425-M314-3F-304-VX8434-010
PVC	Gray	1.5 m	<b>BCC03TU</b> BCC M415-M314-3F-304-VX8434-015	<b>BCC03UA</b> BCC M425-M314-3F-304-VX8434-015
PVC	Gray	2 m	<b>BCC03TW</b> BCC M415-M314-3F-304-VX8434-020	<b>BCC03UC</b> BCC M425-M314-3F-304-VX8434-020
PVC	Gray	3 m	<b>BCC03TY</b> BCC M415-M314-3F-304-VX8434-030	<b>BCC03UE</b> BCC M425-M314-3F-304-VX8434-030
PVC	Gray	5 m	<b>BCC03TZ</b> BCC M415-M314-3F-304-VX8434-050	<b>BCC03UF</b> BCC M425-M314-3F-304-VX8434-050

Other cable materials, colors, and lengths on request.  
Connectors without LED are suitable for PNP and NPN switching functions.  
NPN versions on request.

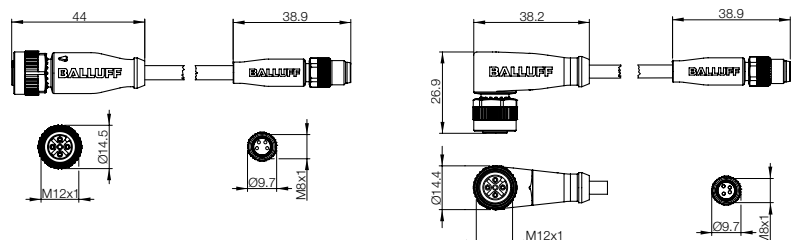

# Connection Cables

## M12 female right-angle ↔ M8 male straight, 4-pin, with LED

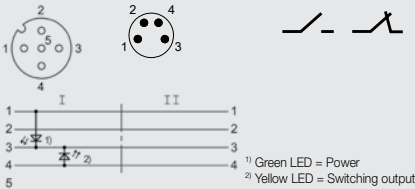

30 V DC  
Molded  
4×0.34 mm<sup>2</sup>  
IP 67  
-25...+90 °C/-25...+90 °C (UL 80 °C)  
-5...+105 °C/-5...+90 °C (UL 80 °C)  
PNP complementary (NO/NC)  $\sim$ / $\sim$ / $\sim$   
Green/yellow

### Ordering code

Part number

#### BCC03TF

BCC M425-M314-3F-606-PX0434-003

#### BCC03TH

BCC M425-M314-3F-606-PX0434-006

#### BCC03TJ

BCC M425-M314-3F-606-PX0434-010

#### BCC03TK

BCC M425-M314-3F-606-PX0434-015

#### BCC03TL

BCC M425-M314-3F-606-PX0434-020

#### BCC03TM

BCC M425-M314-3F-606-PX0434-030

#### BCC03TN

BCC M425-M314-3F-606-PX0434-050

#### BCC03UR

BCC M425-M314-3F-606-VX8434-003

#### BCC03UT

BCC M425-M314-3F-606-VX8434-006

#### BCC03UU

BCC M425-M314-3F-606-VX8434-010

#### BCC03UW

BCC M425-M314-3F-606-VX8434-015

#### BCC03UY

BCC M425-M314-3F-606-VX8434-020

#### BCC03UZ

BCC M425-M314-3F-606-VX8434-030

#### BCC03W0

BCC M425-M314-3F-606-VX8434-050

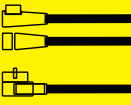

Connectors and cables

Connectors M5

Connection cables M5↔M8

Connectors M8

Connection cables M8↔M8

Connection cables M8↔M12

Connectors M12

Connection cables M12↔M8

Connection cables M12↔M12

Tees, adapters

Y-connectors

Accessories

Special properties

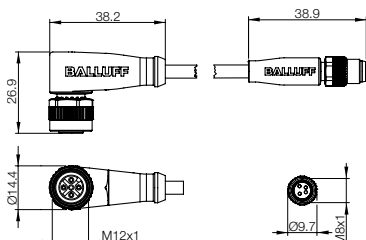

# Connection Cables

## M12 female straight or right-angle ↔ M12 male straight, 3-pin, without LED

M12 ↔ M12



Connector diagram and wiring		
Max. supply voltage AC $U_B$	250 V AC	250 V AC
Max. supply voltage DC $U_B$	250 V DC	250 V DC
Cable	Molded	Molded
Number of conductors × conductor cross-section	3×0.34 mm <sup>2</sup>	3×0.34 mm <sup>2</sup>
Degree of protection as per IEC 60529	IP 68	IP 68
Ambient temperature $T_a$	–40...+90 °C/–25...+90 °C (UL 80° C)	–40...+90 °C/–25...+90 °C (UL 80° C)
Static/moving	PUR	PVC
Use	–40...+105 °C/–5...+105 °C (UL 80 °C)	–40...+105 °C/–5...+105 °C (UL 80 °C)
LED	Normally open (NO) ✓-	Normally open (NO) ✓-

Cable material	Color	Length	Ordering code		
			Part number		
PUR		Black	0.3 m	<b>BCC036Y</b> BCC M415-M413-3A-300-PX0334-003	<b>BCC037E</b> BCC M425-M413-3A-300-PX0334-003
PUR		Black	0.6 m	<b>BCC036Z</b> BCC M415-M413-3A-300-PX0334-006	<b>BCC037F</b> BCC M425-M413-3A-300-PX0334-006
PUR		Black	1 m	<b>BCC0370</b> BCC M415-M413-3A-300-PX0334-010	<b>BCC037H</b> BCC M425-M413-3A-300-PX0334-010
PUR		Black	1.5 m	<b>BCC0371</b> BCC M415-M413-3A-300-PX0334-015	<b>BCC037J</b> BCC M425-M413-3A-300-PX0334-015
PUR		Black	2 m	<b>BCC0372</b> BCC M415-M413-3A-300-PX0334-020	<b>BCC037K</b> BCC M425-M413-3A-300-PX0334-020
PUR		Black	3 m	<b>BCC0373</b> BCC M415-M413-3A-300-PX0334-030	<b>BCC037L</b> BCC M425-M413-3A-300-PX0334-030
PUR		Black	5 m	<b>BCC0374</b> BCC M415-M413-3A-300-PX0334-050	<b>BCC037M</b> BCC M425-M413-3A-300-PX0334-050
PVC		Gray	0.3 m	<b>BCC0386</b> BCC M415-M413-3A-300-VX8334-003	<b>BCC038P</b> BCC M425-M413-3A-300-VX8334-003
PVC		Gray	0.6 m	<b>BCC0387</b> BCC M415-M413-3A-300-VX8334-006	<b>BCC038R</b> BCC M425-M413-3A-300-VX8334-006
PVC		Gray	1 m	<b>BCC0388</b> BCC M415-M413-3A-300-VX8334-010	<b>BCC038T</b> BCC M425-M413-3A-300-VX8334-010
PVC		Gray	1.5 m	<b>BCC0389</b> BCC M415-M413-3A-300-VX8334-015	<b>BCC038U</b> BCC M425-M413-3A-300-VX8334-015
PVC		Gray	2 m	<b>BCC038A</b> BCC M415-M413-3A-300-VX8334-020	<b>BCC038W</b> BCC M425-M413-3A-300-VX8334-020
PVC		Gray	3 m	<b>BCC038C</b> BCC M415-M413-3A-300-VX8334-030	<b>BCC038Y</b> BCC M425-M413-3A-300-VX8334-030
PVC		Gray	5 m	<b>BCC038E</b> BCC M415-M413-3A-300-VX8334-050	<b>BCC038Z</b> BCC M425-M413-3A-300-VX8334-050

Other cable materials, colors, and lengths on request.  
Connectors without LED are suitable for PNP and NPN switching functions.  
NPN versions on request.

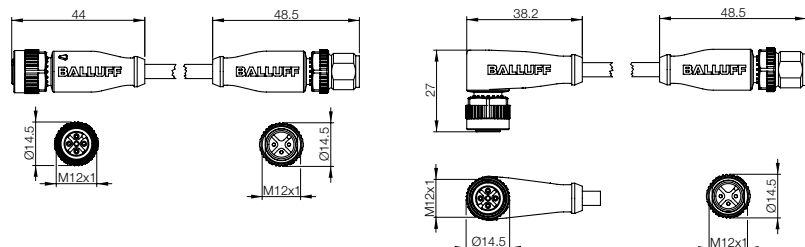

# Connection Cables

## M12 female right-angle ↔ M12 male straight, 3-pin, with LED

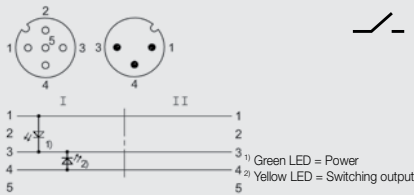

30 V DC  
 Molded  
 3×0.34 mm<sup>2</sup>  
 IP 68  
 -40...+90 °C/-25...+90 °C (UL 80° C)  
 -40...+105 °C/-5...+105 °C (UL 80 °C)  
 PNP normally open (NO) ✓-  
 Green/yellow

### Ordering code

Part number

#### BCC037Z

BCC M425-M413-3A-602-PX0334-003

#### BCC0380

BCC M425-M413-3A-602-PX0334-006

#### BCC0381

BCC M425-M413-3A-602-PX0334-010

#### BCC0382

BCC M425-M413-3A-602-PX0334-015

#### BCC0383

BCC M425-M413-3A-602-PX0334-020

#### BCC0384

BCC M425-M413-3A-602-PX0334-030

#### BCC0385

BCC M425-M413-3A-602-PX0334-050

#### BCC0397

BCC M425-M413-3A-602-VX8334-003

#### BCC0398

BCC M425-M413-3A-602-VX8334-006

#### BCC0399

BCC M425-M413-3A-602-VX8334-010

#### BCC039A

BCC M425-M413-3A-602-VX8334-015

#### BCC039C

BCC M425-M413-3A-602-VX8334-020

#### BCC039E

BCC M425-M413-3A-602-VX8334-030

#### BCC039F

BCC M425-M413-3A-602-VX8334-050

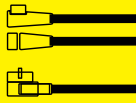

Connectors and cables

Connectors M5

Connection cables M5↔M8

Connectors M8

Connection cables M8↔M8

Connection cables M8↔M12

Connectors M12

Connection cables M12↔M8

Connection cables M12↔M12

Tees, adapters

Y-connectors

Accessories

Special properties

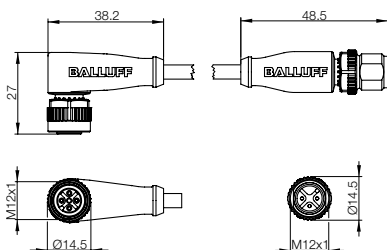



Connector diagram and wiring	 		 	
Max. supply voltage AC $U_B$	250 V AC		30 V DC	
Max. supply voltage DC $U_B$	250 V DC			
Cable	Molded		Molded	
Number of conductors × conductor cross-section	4×0.34 mm <sup>2</sup>		4×0.34 mm <sup>2</sup>	
Degree of protection as per IEC 60529	IP 68		IP 68	
Ambient temperature $T_a$	PUR -40...+90 °C/-25...+90 °C (UL 80° C)		PVC -40...+90 °C/-25...+90 °C (UL 80° C)	
Static/moving	PUR -40...+105 °C/-5...+105 °C (UL 80 °C)		PVC -40...+105 °C/-5...+105 °C (UL 80 °C)	
Use	Complementary (NO/NC)		Complementary (NO/NC)	
LED			Green/yellow	

Cable material	Color	Length	Ordering code		
			Part number		
PUR		Black	0.3 m	<b>BCC039H</b> BCC M415-M414-3A-304-PX0434-003	<b>BCC03A1</b> BCC M415-M414-3A-606-PX0434-003
PUR		Black	0.6 m	<b>BCC039J</b> BCC M415-M414-3A-304-PX0434-006	<b>BCC03A2</b> BCC M415-M414-3A-606-PX0434-006
PUR		Black	1 m	<b>BCC039K</b> BCC M415-M414-3A-304-PX0434-010	<b>BCC03A3</b> BCC M415-M414-3A-606-PX0434-010
PUR		Black	1.5 m	<b>BCC039L</b> BCC M415-M414-3A-304-PX0434-015	<b>BCC03A4</b> BCC M415-M414-3A-606-PX0434-015
PUR		Black	2 m	<b>BCC039M</b> BCC M415-M414-3A-304-PX0434-020	<b>BCC03A5</b> BCC M415-M414-3A-606-PX0434-020
PUR		Black	3 m	<b>BCC039N</b> BCC M415-M414-3A-304-PX0434-030	<b>BCC03A6</b> BCC M415-M414-3A-606-PX0434-030
PUR		Black	5 m	<b>BCC039P</b> BCC M415-M414-3A-304-PX0434-050	<b>BCC03A7</b> BCC M415-M414-3A-606-PX0434-050
PVC		Gray	0.3 m	<b>BCC03C9</b> BCC M415-M414-3A-304-VX8434-003	<b>BCC03CU</b> BCC M415-M414-3A-606-VX8434-003
PVC		Gray	0.6 m	<b>BCC03CA</b> BCC M415-M414-3A-304-VX8434-006	<b>BCC03CW</b> BCC M415-M414-3A-606-VX8434-006
PVC		Gray	1 m	<b>BCC03CC</b> BCC M415-M414-3A-304-VX8434-010	<b>BCC03CY</b> BCC M415-M414-3A-606-VX8434-010
PVC		Gray	1.5 m	<b>BCC03CE</b> BCC M415-M414-3A-304-VX8434-015	<b>BCC03CZ</b> BCC M415-M414-3A-606-VX8434-015
PVC		Gray	2 m	<b>BCC03CF</b> BCC M415-M414-3A-304-VX8434-020	<b>BCC03E0</b> BCC M415-M414-3A-606-VX8434-020
PVC		Gray	3 m	<b>BCC03CH</b> BCC M415-M414-3A-304-VX8434-030	<b>BCC03E1</b> BCC M415-M414-3A-606-VX8434-030
PVC		Gray	5 m	<b>BCC03CJ</b> BCC M415-M414-3A-304-VX8434-050	<b>BCC03E2</b> BCC M415-M414-3A-606-VX8434-050

Other cable materials, colors, and lengths on request.  
Connectors without LED are suitable for PNP and NPN switching functions.  
NPN versions on request.

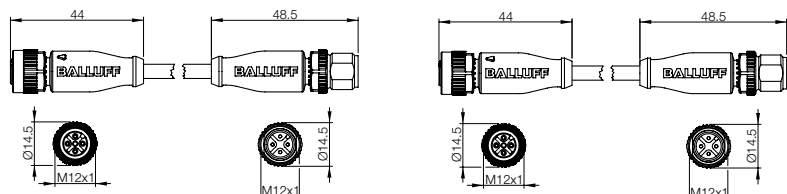



# Connection Cables

## M12 female right-angle ↔ M12 male straight, 4-pin, without and with LED

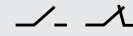
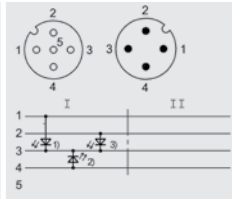
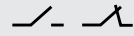
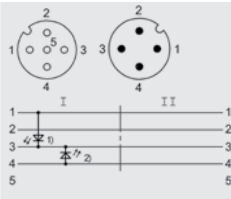
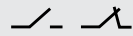
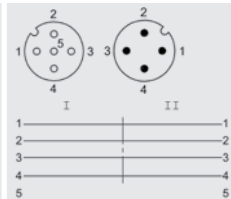

<sup>1</sup> Green LED = Power  
<sup>2</sup> Yellow LED = Switching output

<sup>1</sup> Green LED = Power  
<sup>2</sup> Yellow LED = Switching output  
<sup>3</sup> White LED = Switching output

250 V AC	30 V DC	30 V DC
250 V DC	Molded	Molded
Molded	4x0.34 mm <sup>2</sup>	4x0.34 mm <sup>2</sup>
4x0.34 mm <sup>2</sup>	IP 68	IP 68
IP 68	-40...+90 °C/-25...+90 °C (UL 80° C)	-40...+90 °C/-25...+90 °C (UL 80° C)
-40...+90 °C/-25...+90 °C (UL 80° C)	-40...+105 °C/-5...+105 °C (UL 80 °C)	-40...+105 °C/-5...+105 °C (UL 80 °C)
-40...+105 °C/-5...+105 °C (UL 80 °C)	PNP complementary (NO/NC) —/—/—	PNP complementary (NO/NC) —/—/—
Complementary (NO/NC) —/—/—	Green/yellow	Green/yellow/white

Ordering code		
Part number		
<b>BCC03A8</b>	<b>BCC03AT</b>	<b>BCC03C2</b>
BCC M425-M414-3A-304-PX0434-003	BCC M425-M414-3A-606-PX0434-003	BCC M425-M414-3A-650-PX0434-003
<b>BCC03A9</b>	<b>BCC03AU</b>	<b>BCC03C3</b>
BCC M425-M414-3A-304-PX0434-006	BCC M425-M414-3A-606-PX0434-006	BCC M425-M414-3A-650-PX0434-006
<b>BCC03AA</b>	<b>BCC03AW</b>	<b>BCC03C4</b>
BCC M425-M414-3A-304-PX0434-010	BCC M425-M414-3A-606-PX0434-010	BCC M425-M414-3A-650-PX0434-010
<b>BCC03AC</b>	<b>BCC03AY</b>	<b>BCC03C5</b>
BCC M425-M414-3A-304-PX0434-015	BCC M425-M414-3A-606-PX0434-015	BCC M425-M414-3A-650-PX0434-015
<b>BCC03AE</b>	<b>BCC03AZ</b>	<b>BCC03C6</b>
BCC M425-M414-3A-304-PX0434-020	BCC M425-M414-3A-606-PX0434-020	BCC M425-M414-3A-650-PX0434-020
<b>BCC03AF</b>	<b>BCC03C0</b>	<b>BCC03C7</b>
BCC M425-M414-3A-304-PX0434-030	BCC M425-M414-3A-606-PX0434-030	BCC M425-M414-3A-650-PX0434-030
<b>BCC03AH</b>	<b>BCC03C1</b>	<b>BCC03C8</b>
BCC M425-M414-3A-304-PX0434-050	BCC M425-M414-3A-606-PX0434-050	BCC M425-M414-3A-650-PX0434-050
<b>BCC03E3</b>	<b>BCC03EL</b>	<b>BCC03EW</b>
BCC M425-M414-3A-304-VX8434-003	BCC M425-M414-3A-606-VX8434-003	BCC M425-M414-3A-650-VX8434-003
<b>BCC03E4</b>	<b>BCC03EM</b>	<b>BCC03Y4</b>
BCC M425-M414-3A-304-VX8434-006	BCC M425-M414-3A-606-VX8434-006	BCC M425-M414-3A-650-VX8434-006
<b>BCC03E5</b>	<b>BCC03EN</b>	<b>BCC03EZ</b>
BCC M425-M414-3A-304-VX8434-010	BCC M425-M414-3A-606-VX8434-010	BCC M425-M414-3A-650-VX8434-010
<b>BCC03E6</b>	<b>BCC03EP</b>	<b>BCC03F0</b>
BCC M425-M414-3A-304-VX8434-015	BCC M425-M414-3A-606-VX8434-015	BCC M425-M414-3A-650-VX8434-015
<b>BCC03E7</b>	<b>BCC03ER</b>	<b>BCC03F1</b>
BCC M425-M414-3A-304-VX8434-020	BCC M425-M414-3A-606-VX8434-020	BCC M425-M414-3A-650-VX8434-020
<b>BCC03E8</b>	<b>BCC03ET</b>	<b>BCC03F2</b>
BCC M425-M414-3A-304-VX8434-030	BCC M425-M414-3A-606-VX8434-030	BCC M425-M414-3A-650-VX8434-030
<b>BCC03E9</b>	<b>BCC03EU</b>	<b>BCC03F3</b>
BCC M425-M414-3A-304-VX8434-050	BCC M425-M414-3A-606-VX8434-050	BCC M425-M414-3A-650-VX8434-050

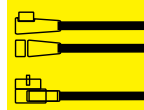

Connectors and cables  
Connectors M5  
Connection cables M5↔M8  
Connectors M8  
Connection cables M8↔M8  
Connection cables M8↔M12  
Connectors M12  
Connection cables M12↔M8  
Connection cables M12↔M12  
Tees, adapters  
Y-connectors  
Accessories  
Special properties

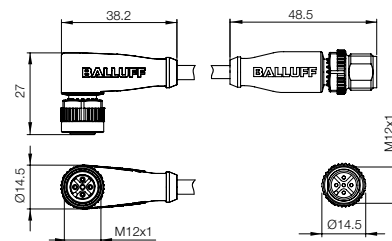
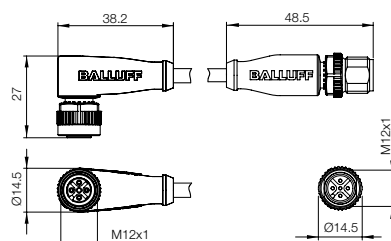
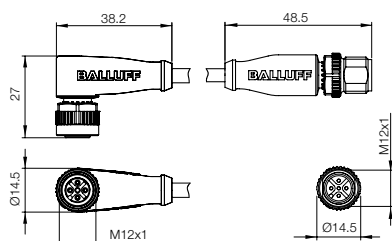

# Connection Cables

## M12 female straight ↔ M12 male straight, 5-pin, no LED

# M12 ↔ M12



Connector diagram and wiring	 I II 1 1 2 2 3 3 4 4 5 5 Gray	 I II 1 1 2 2 3 3 4 4 5 5 Green/yellow
Max. supply voltage AC $U_B$	125 V AC	125 V AC
Max. supply voltage DC $U_B$	125 V DC	125 V DC
Cable	Molded	Molded
Number of conductors × conductor cross-section	5×0.34 mm <sup>2</sup>	5×0.34 mm <sup>2</sup>
Degree of protection as per IEC 60529	IP 68	IP 68
Ambient temperature $T_a$	-40...+90 °C (UL 80 °C)	-40...+90 °C (UL 80 °C)
Static PUR Tensioned PUR	-25...+90 °C (UL 80 °C)	-25...+90 °C (UL 80 °C)
Use	Normally open and normally closed	Normally open and normally closed
LED		

Cable material	Color	Length	Ordering code
PUR		Black	0.3 m
			Part number
			<b>BCC09FL</b> <b>BCC09FW</b>
			BCC M415-M415-3A-312-PX0534-003 BCC M415-M415-3A-313-PX0534-003
PUR		Black	0.6 m
			<b>BCC09FM</b> <b>BCC09FY</b>
			BCC M415-M415-3A-312-PX0534-006 BCC M415-M415-3A-313-PX0534-006
PUR		Black	1 m
			<b>BCC09FN</b> <b>BCC09FZ</b>
			BCC M415-M415-3A-312-PX0534-010 BCC M415-M415-3A-313-PX0534-010
PUR		Black	1.5 m
			<b>BCC09FP</b> <b>BCC09H0</b>
			BCC M415-M415-3A-312-PX0534-015 BCC M415-M415-3A-313-PX0534-015
PUR		Black	2 m
			<b>BCC09FR</b> <b>BCC09H1</b>
			BCC M415-M415-3A-312-PX0534-020 BCC M415-M415-3A-313-PX0534-020
PUR		Black	3 m
			<b>BCC09FT</b> <b>BCC09H2</b>
			BCC M415-M415-3A-312-PX0534-030 BCC M415-M415-3A-313-PX0534-030
PUR		Black	5 m
			<b>BCC09FU</b> <b>BCC09H3</b>
			BCC M415-M415-3A-312-PX0534-050 BCC M415-M415-3A-313-PX0534-050
PUR		Black	10 m
			<b>BCC0AJC</b>
			BCC M415-M415-3A-313-PX0534-100

Other cable materials, colors, and lengths on request.  
 Connectors without LED are suitable for PNP and NPN switching functions.  
 NPN versions on request.

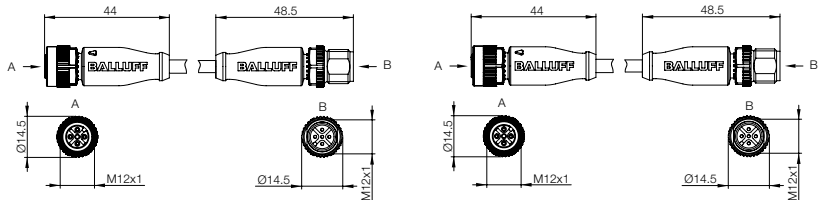

# Connection Cables

**M12 female right-angle ↔ M12 male straight, 5-pin, with and without LED**

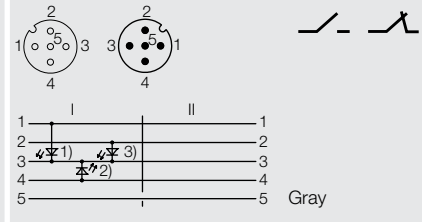
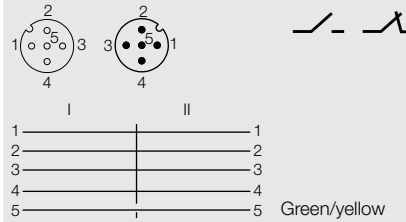
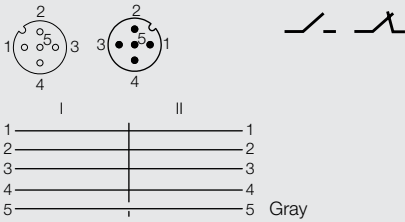

125 V AC	125 V AC	30 V DC
125 V DC	125 V DC	Molded
Molded	Molded	5×0.34 mm <sup>2</sup>
5×0.34 mm <sup>2</sup>	5×0.34 mm <sup>2</sup>	IP 68
IP 68	IP 68	-40...+90 °C (UL 80 °C)
-40...+90 °C (UL 80 °C)	-40...+90 °C (UL 80 °C)	-25...+90 °C (UL 80 °C)
-25...+90 °C (UL 80 °C)	-25...+90 °C (UL 80 °C)	Normally open and normally closed
Normally open and normally closed	Normally open and normally closed	Green/yellow/white

Ordering code		
Part number		
<b>BCC08H8</b>	<b>BCC08H0</b>	<b>BCC09FA</b>
BCC M425-M415-3A-312-PX0534-003	BCC M425-M415-3A-313-PX0534-003	BCC M425-M415-3A-660-PX0534-003
<b>BCC08H9</b>	<b>BCC08H1</b>	<b>BCC09FC</b>
BCC M425-M415-3A-312-PX0534-006	BCC M425-M415-3A-313-PX0534-006	BCC M425-M415-3A-660-PX0534-006
<b>BCC08HA</b>	<b>BCC08H2</b>	<b>BCC09FE</b>
BCC M425-M415-3A-312-PX0534-010	BCC M425-M415-3A-313-PX0534-010	BCC M425-M415-3A-660-PX0534-010
<b>BCC08HC</b>	<b>BCC08H3</b>	<b>BCC09FH</b>
BCC M425-M415-3A-312-PX0534-015	BCC M425-M415-3A-313-PX0534-015	BCC M425-M415-3A-660-PX0534-015
<b>BCC08HE</b>	<b>BCC08H4</b>	<b>BCC09FF</b>
BCC M425-M415-3A-312-PX0534-020	BCC M425-M415-3A-313-PX0534-020	BCC M425-M415-3A-660-PX0534-020
<b>BCC08HF</b>	<b>BCC08H5</b>	<b>BCC09FJ</b>
BCC M425-M415-3A-312-PX0534-030	BCC M425-M415-3A-313-PX0534-030	BCC M425-M415-3A-660-PX0534-030
<b>BCC08HH</b>	<b>BCC08H6</b>	<b>BCC09FK</b>
BCC M425-M415-3A-312-PX0534-050	BCC M425-M415-3A-313-PX0534-050	BCC M425-M415-3A-660-PX0534-050

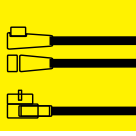

Connectors and cables  
 Connectors M5  
 Connection cables M5↔M8  
 Connectors M8  
 Connection cables M8↔M8  
 Connection cables M8↔M12  
 Connectors M12  
 Connection cables M12↔M8  
 Connection cables M12↔M12  
 Tees, adapters  
 Y-connectors  
 Accessories  
 Special properties

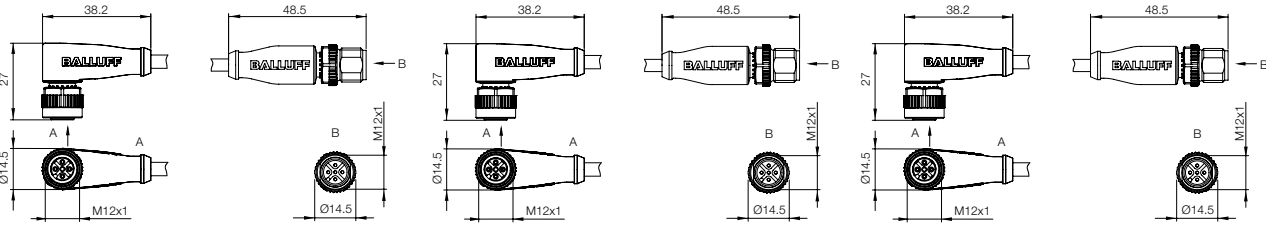

# Connection Cables

## M12 female right-angle ↔ M12 male straight, 5-pin, with LED

# M12 ↔ M12



Connector diagram and wiring

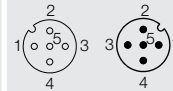
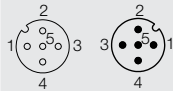

Max. supply voltage AC  $U_B$

Max. supply voltage DC  $U_B$

Cable

Number of conductors × conductor cross-section

Degree of protection as per IEC 60529

Ambient temperature  $T_a$

LED

30 V DC

Molded

5×0.34 mm<sup>2</sup>

IP 68

Static PUR -40...+90 °C (UL 80 °C)

Tensioned PUR -25...+90 °C (UL 80 °C)

Green/yellow/white

30 V DC

Molded

5×0.34 mm<sup>2</sup>

IP 68

Static PUR -40...+90 °C (UL 80 °C)

Tensioned PUR -25...+90 °C (UL 80 °C)

green/yellow/red

Cable material	Color	Length	Ordering code	
			Part number	
PUR	Black	0.3 m	<b>BCC09F9</b> BCC M425-M415-3A-661-PX0534-003	<b>BCC0C4J</b> BCC M425-M415-3A-692-PX0534-003
PUR	Black	0.6 m	<b>BCC09F8</b> BCC M425-M415-3A-661-PX0534-006	<b>BCC0C4H</b> BCC M425-M415-3A-692-PX0534-006
PUR	Black	1 m	<b>BCC09F7</b> BCC M425-M415-3A-661-PX0534-010	<b>BCC0C4F</b> BCC M425-M415-3A-692-PX0534-010
PUR	Black	1.5 m	<b>BCC09F3</b> BCC M425-M415-3A-661-PX0534-015	<b>BCC0C4E</b> BCC M425-M415-3A-692-PX0534-015
PUR	Black	2 m	<b>BCC09F4</b> BCC M425-M415-3A-661-PX0534-020	<b>BCC0C4C</b> BCC M425-M415-3A-692-PX0534-020
PUR	Black	3 m	<b>BCC09F5</b> BCC M425-M415-3A-661-PX0534-030	<b>BCC0C4A</b> BCC M425-M415-3A-692-PX0534-030
PUR	Black	5 m	<b>BCC09F6</b> BCC M425-M415-3A-661-PX0534-050	<b>BCC0C49</b> BCC M425-M415-3A-692-PX0534-050

Other cable materials, colors, and lengths on request.

Connectors without LED are suitable for PNP and NPN switching functions.

NPN versions on request.

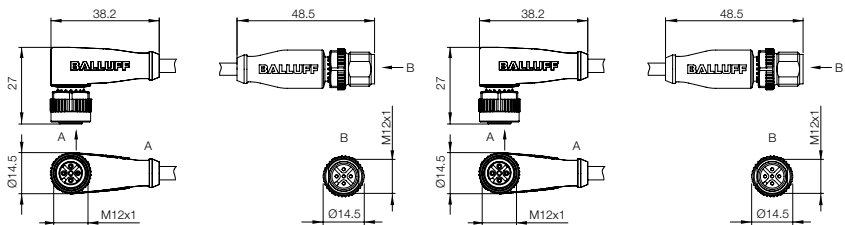

# Connection Cables

## M12 female straight ↔ M12 male straight, 8-pin, without LED

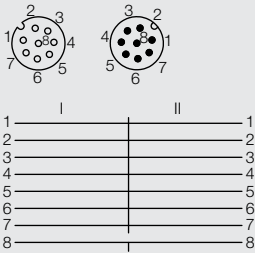

60 V AC  
 60 V DC  
 Molded  
 8×0.25 mm<sup>2</sup>  
 IP 68  
 -40...+90 °C (UL 80 °C)  
 -25...+90 °C (UL 80 °C)

### Ordering code

Part number

**BCC0AC0**

BCC M418-M418-3A-342-PX0825-003

**BCC0AAZ**

BCC M418-M418-3A-342-PX0825-006

**BCC0AC1**

BCC M418-M418-3A-342-PX0825-010

**BCC0AC2**

BCC M418-M418-3A-342-PX0825-015

**BCC0AC3**

BCC M418-M418-3A-342-PX0825-020

**BCC0AC4**

BCC M418-M418-3A-342-PX0825-030

**BCC0AC5**

BCC M418-M418-3A-342-PX0825-050

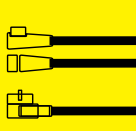

Connectors and cables

Connectors M5

Connection cables M5↔M8

Connectors M8

Connection cables M8↔M8

Connection cables M8↔M12

Connectors M12

Connection cables M12↔M8

Connection cables M12↔M12

Tees, adapters

Y-connectors

Accessories

Special properties

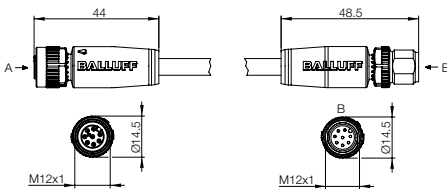



Connector diagram				
Version	M12 female straight	M12 female straight	M12 female right-angle	
Max. supply voltage AC $U_B$	250 V AC	250 V AC	250 V AC	
Max. supply voltage DC $U_B$	250 V DC	250 V DC	250 V DC	
Cable	User-fabricated	User-fabricated	User-fabricated	
Number of conductors × conductor cross-section	4×0.14...0.75 mm <sup>2</sup>	4×0.14...0.50 mm <sup>2</sup>	4×0.14...0.75 mm <sup>2</sup>	
Connection	Screw terminal	Spring clamp terminal	Screw terminal	
Degree of protection as per IEC 60529	IP 67	IP 67	IP 67	
Ambient temperature $T_a$	-40...+85 °C	-25...+85 °C	-40...+85 °C	

Cable dia.	Ordering code		
	Part number		
Ø 4...6 mm, no LED, NO and NC	<b>BCC06Z9</b> BCC M435-0000-1A-000-41X475-000		<b>BCC06ZA</b> BCC M445-0000-1A-000-41X475-000
Ø 6...8 mm, no LED, NO and NC	<b>BCC06F6</b> BCC M435-0000-1A-000-51X475-000	<b>BCC06Y6</b> BCC M435-0000-1A-000-55X450-000	<b>BCC06Y8</b> BCC M445-0000-1A-000-51X475-000

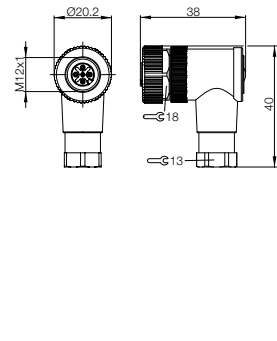
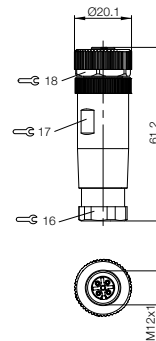
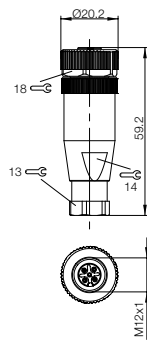

# Connectors

## M12 male straight and right-angle, M12 female straight and right-angle, user-fabricated



M12 male, straight	M12 male, straight	M12 male right-angle	M12 female straight	M12 female right-angle
250 V AC	250 V AC	250 V AC	125 V AC	125 V AC
250 V DC	250 V DC	250 V DC	125 V DC	125 V DC
User-fabricated	User-fabricated	User-fabricated	User-fabricated	User-fabricated
4x0.14...0.75 mm <sup>2</sup>	4x0.14...0.50 mm <sup>2</sup>	4x0.14...0.75 mm <sup>2</sup>	5x0.14...0.75 mm <sup>2</sup>	5x0.14...0.75 mm <sup>2</sup>
Screw terminal	Spring clamp terminal	Screw terminal	Screw terminal	Screw terminal
IP 67	IP 67	IP 67	IP 67	IP 67
-40...+85 °C	-25...+85 °C	-40...+85 °C	-40...+85 °C	-40...+85 °C

### Ordering code

Part number

<b>BCC06M4</b>		<b>BCC06ZC</b>	<b>BCC06ZF</b>	<b>BCC06ZH</b>
BCC M434-0000-2A-000-41X475-000		BCC M444-0000-2A-000-41X475-000	BCC M435-000-1A-000-41X575-000	BCC M445-000-1A-000-41X575-000
<b>BCC06F7</b>	<b>BCC06Y5</b>	<b>BCC06ZE</b>	<b>BCC06W9</b>	<b>BCC06ZJ</b>
BCC M434-0000-2A-000-51X475-000	BCC M434-0000-2A-000-55X450-000	BCC M444-0000-2A-000-51X475-000	BCC M435-0000-1A-000-51X575-000	BCC M445-0000-1A-000-51X575-000

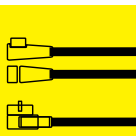
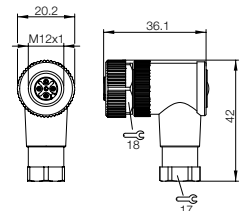
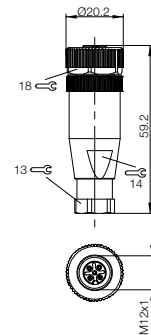
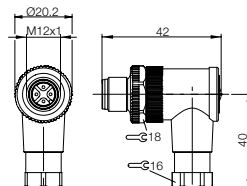
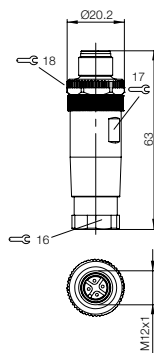
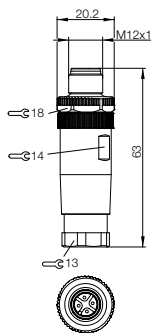

Connectors and cables

Connectors M5

Connection cables M5↔M8

Connectors M8

Connection cables M8↔M8

Connection cables M8↔M12

**Connectors M12**

Connection cables M12↔M8

Connection cables M12↔M12

Tees, adapters

Y-connectors

Accessories

Special properties

## M12 male straight and right-angle, M12 female straight, User-fabricated



Connector diagram				
Version	Male straight	Male right-angle	Male straight	Female straight
Max. supply voltage AC $U_B$	125 V AC	125 V AC	125 V AC	125 V AC
Max. supply voltage DC $U_B$	125 V DC	125 V DC	125 V DC	125 V DC
Cable	User-fabricated	User-fabricated	User-fabricated	User-fabricated
Number of conductors × conductor cross-section	5×0.14...0.75 mm <sup>2</sup>	5×0.14...0.75 mm <sup>2</sup>	4×0.14...0.34 mm <sup>2</sup>	4×0.14...0.34 mm <sup>2</sup>
Cable diameter			Ø 3.5...6 mm	Ø 3.5...6 mm
Connection	Screw terminal	Screw terminal	Insulation displacement connector technology	Insulation displacement connector technology
Degree of protection as per IEC 60529	IP 67	IP 67	IP 67	IP 67
Ambient temperature $T_a$	-40...+85 °C	-40...+85 °C	-25...+80 °C	-25...+80 °C
Use			Female S4	Plug sensor S4

Cable dia.	Ordering code			
	Part number			
Ø 4...6 mm, no LED, NO and NC	<b>BCC06YA</b> BCC M435-0000-2A-000-41X575-000	<b>BCC06ZK</b> BCC M445-000-2A-000-41X575-000	<b>BCC08C0</b> BCC M434-0000-2A-000-43X434-000	<b>BCC06ZY</b> BCC M435-0000-1A-000-43X434-000
Ø 6...8 mm, no LED, NO and NC	<b>BCC06EY</b> BCC M435-0000-2A-000-51X575-000	<b>BCC06ZL</b> BCC M445-0000-2A-000-51X575-000		

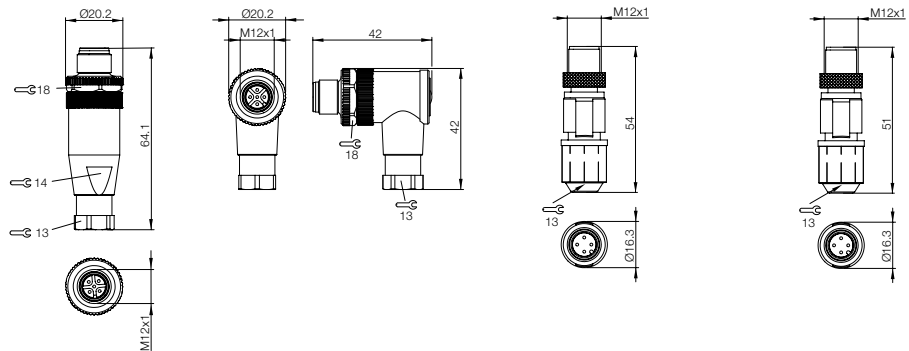



# Connectors

## M12 male straight and right-angle, M12 female straight and right-angle, user-fabricated



Quick-connect system



Quick-connect system



Quick-connect system



Quick-connect system



Female straight  
30 V AC  
30 V DC  
User-fabricated  
4x0.14...0.34 mm<sup>2</sup>  
Ø 2.9...5.1 mm  
Insulation displacement connector technology  
IP 67  
-25...+85 °C  
Plug sensor S4



Male straight  
30 V AC  
30 V DC  
User-fabricated  
4x0.14...0.34 mm<sup>2</sup>  
Ø 2.9...5.1 mm  
Insulation displacement connector technology  
IP 67  
-25...+85 °C  
Female S4



Female right-angle  
30 V AC  
30 V DC  
User-fabricated  
4x0.25...0.5 mm<sup>2</sup>  
Ø 4...5.1 mm  
Insulation displacement connector technology  
IP 67  
-25...+85 °C  
Plug sensor S4



Male right-angle  
30 V AC  
30 V DC  
User-fabricated  
4x0.25...0.5 mm<sup>2</sup>  
Ø 4...5.1 mm  
Insulation displacement connector technology  
IP 67  
-25...+85 °C  
Female S4

### Ordering code

Part number

**BCC02H8**

BKS-S107-RT14

**BCC02H9**

BKS-S109-RT14

**BCC02H6**

BKS-S 76-RT04

**BCC02H7**

BKS-S 77-RT04

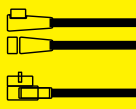
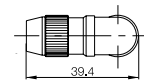
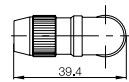
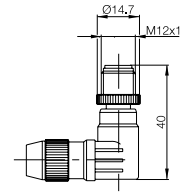
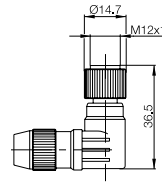
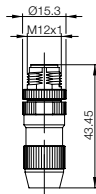
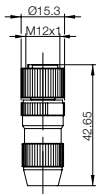

Connectors and cables

Connectors M5

Connection cables M5↔M8

Connectors M8

Connection cables M8↔M8

Connection cables M8↔M12

### Connectors M12

Connection cables M12↔M8

Connection cables M12↔M12

Tees, adapters

Y-connectors

Accessories

Special properties



Connector diagram		
Version	Female straight	Male straight
Max. supply voltage AC $U_B$	125 V AC	125 V AC
Max. supply voltage DC $U_B$	125 V DC	125 V DC
Cable	User-fabricated	User-fabricated
Number of conductors x conductor cross-section	5x0.14...0.75 mm <sup>2</sup>	5x0.14...0.75 mm <sup>2</sup>
Cable diameter 1/2	2.1...3mm/4...5 mm	2.1...3mm/4...5 mm
Connection	Screw terminal	Screw terminal
Degree of protection as per IEC 60529	IP 67	IP 67
Ambient temperature $T_a$	-40...+85 °C	-40...+85 °C

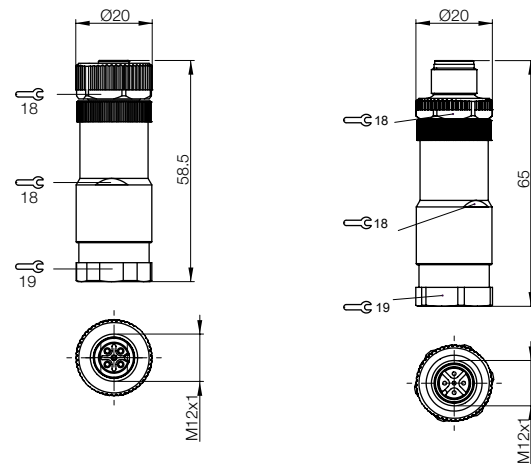

<b>Cable material</b>	<b>Ordering code</b>	
PUR	Part number	
	<b>BCC09JP</b>	<b>BCC09JW</b>
	BCC M435-0000-1A-000-A1X575-000	BCC M435-0000-2A-000-A1X575-000



# Connectors

## M12 female straight and right-angle, 8-pin, user-fabricated



View of female/ male side		1 _____ 2 _____ 3 _____ 4 _____ 5 _____ 6 _____ 7 _____ 8 _____		1 _____ 2 _____ 3 _____ 4 _____ 5 _____ 6 _____ 7 _____ 8 _____
Version	Female straight		Female right-angle	
Max. supply voltage AC $U_B$	30 V AC		30 V AC	
Max. supply voltage DC $U_B$	30 V DC		30 V DC	
Cable diameter	4...8 mm		4...8 mm	
Cable	User-fabricated		User-fabricated	
Number of conductors × conductor cross-section	8×0.14...0.25 mm <sup>2</sup>		8×0.14...0.25 mm <sup>2</sup>	
Housing material	CuZn		CuZn	
Degree of protection as per IEC 60529	IP 67		IP 67	
Ambient temperature $T_a$	-25...+85 °C		-25...+85 °C	
Use	BPI, M8, 3-pin, 8-way, BIC		BPI, M8, 3-pin, 8-way, BIC	

	<b>Ordering code</b>	
	Part number	
	<b>BCC04MC</b>	<b>BCC04ME</b>
	BCC M478-0000-1A-000-43X834-000	BCC M488-0000-1A-000-43X834-000

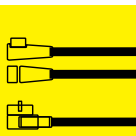
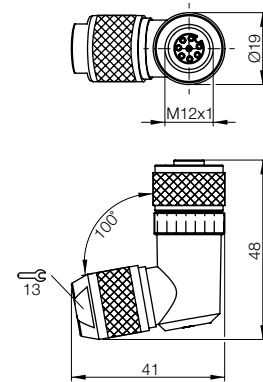
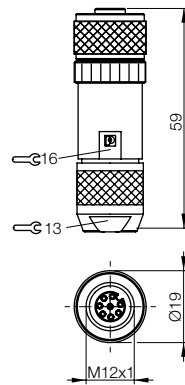

Connectors and cables  
 Connectors M5  
 Connection cables M5↔M8  
 Connectors M8  
 Connection cables M8↔M8  
 Connection cables M8↔M12  
**Connectors M12**  
 Connection cables M12↔M8  
 Connection cables M12↔M12  
 Tees, adapters  
 Y-connectors  
 Accessories  
 Special properties



Connector diagram and wiring

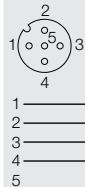

PIN 1: brown  
PIN 2: white  
PIN 3: blue  
PIN 4: black

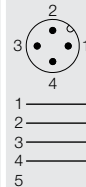

PIN 1: brown  
PIN 2: white  
PIN 3: blue  
PIN 4: black



Max. supply voltage AC  $U_B$

250 V

250 V

Max. supply voltage DC  $U_B$

250 V

250 V

Number of conductors x conductor cross-section

4x0.25 mm<sup>2</sup>

4x0.25 mm<sup>2</sup>

Degree of protection as per IEC 60529

IP 68

IP 68

Ambient temperature  $T_a$

-25...+85 °C

-25...+85 °C

**Cable length**

**Ordering code**

Part number

0.5 m

**BCC099C**

**BCC099A**

BCC M455-0000-1A-RM020-005

BCC M454-0000-2A-RM020-005

2 m

**BCC0CAE**

**BCC0E53**

BCC M455-0000-1A-RM020-020

BCC M454-0000-2A-RM020-020

Other cable lengths on request.

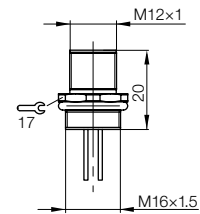
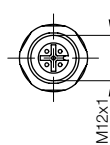
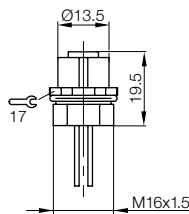

# Plug connector

## M12 flange socket, M12 flange plug, 5-pin and 8-pin



PIN 1: brown  
PIN 2: white  
PIN 3: blue  
PIN 4: black  
PIN 5: gray

- 1 \_\_\_\_\_
- 2 \_\_\_\_\_
- 3 \_\_\_\_\_
- 4 \_\_\_\_\_
- 5 \_\_\_\_\_

250 V  
250 V  
5x0.25 mm<sup>2</sup>  
IP 68  
-25...+85 °C



PIN 1: brown  
PIN 2: white  
PIN 3: blue  
PIN 4: black  
PIN 5: gray

- 1 \_\_\_\_\_
- 2 \_\_\_\_\_
- 3 \_\_\_\_\_
- 4 \_\_\_\_\_
- 5 \_\_\_\_\_

250 V  
250 V  
5x0.25 mm<sup>2</sup>  
IP 68  
-25...+85 °C



PIN 1: white  
PIN 2: brown  
PIN 3: green  
PIN 4: yellow  
PIN 5: gray  
PIN 6: pink  
PIN 7: blue  
PIN 8: red

- 1 \_\_\_\_\_
- 2 \_\_\_\_\_
- 3 \_\_\_\_\_
- 4 \_\_\_\_\_
- 5 \_\_\_\_\_
- 6 \_\_\_\_\_
- 7 \_\_\_\_\_
- 8 \_\_\_\_\_

60 V  
60 V  
8x0.25 mm<sup>2</sup>  
IP 68  
-25...+85 °C



PIN 1: white  
PIN 2: brown  
PIN 3: green  
PIN 4: yellow  
PIN 5: gray  
PIN 6: pink  
PIN 7: blue  
PIN 8: red

- 1 \_\_\_\_\_
- 2 \_\_\_\_\_
- 3 \_\_\_\_\_
- 4 \_\_\_\_\_
- 5 \_\_\_\_\_
- 6 \_\_\_\_\_
- 7 \_\_\_\_\_
- 8 \_\_\_\_\_

60 V  
60 V  
8x0.25 mm<sup>2</sup>  
IP 68  
-25...+85 °C

### Ordering code

Part number

#### BCC09JZ

BCC M455-0000-1A-RM014-005

#### BCC09K0

BCC M455-0000-2A-RM014-005

#### BCC0E55

BCC M458-0000-1A-RM015-005

#### BCC0E57

BCC M458-0000-2A-RM015-005

#### BCC0E54

BCC M455-0000-1A-RM014-020

#### BCC0E5F

BCC M455-0000-2A-RM014-020

#### BCC0E56

BCC M458-0000-1A-RM015-020

#### BCC0E58

BCC M458-0000-2A-RM015-020

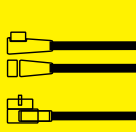
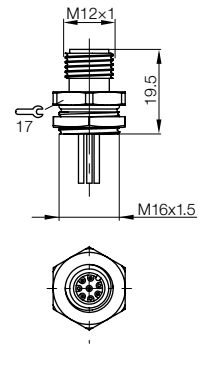
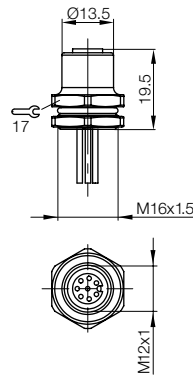
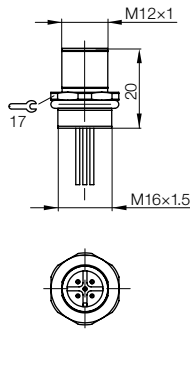
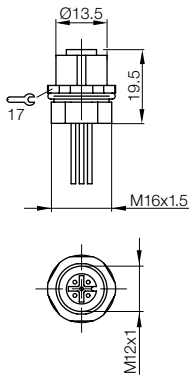

Connectors and cables

Connectors M5

Connection cables M5↔M8

Connectors M8

Connection cables M8↔M8

Connection cables M8↔M12

### Connectors M12

Connection cables M12↔M8

Connection cables M12↔M12

Tees, adapters

Y-connectors

Accessories

Special properties



Connector diagram and wiring



- PIN 1: brown
- PIN 2: blue
- PIN 3: white
- PIN 4: green
- PIN 5: pink
- PIN 6: yellow
- PIN 7: black
- PIN 8: gray
- PIN 9: red
- PIN 10: purple
- PIN 11: gray/pink
- PIN 12: red/blue

- 1 \_\_\_\_\_
- 2 \_\_\_\_\_
- 3 \_\_\_\_\_
- 4 \_\_\_\_\_
- 5 \_\_\_\_\_
- 6 \_\_\_\_\_
- 7 \_\_\_\_\_
- 8 \_\_\_\_\_
- 9 \_\_\_\_\_
- 10 \_\_\_\_\_
- 11 \_\_\_\_\_
- 12 \_\_\_\_\_



- PIN 1: brown
- PIN 2: blue
- PIN 3: white
- PIN 4: green
- PIN 5: pink
- PIN 6: yellow
- PIN 7: black
- PIN 8: gray
- PIN 9: red
- PIN 10: purple
- PIN 11: gray/pink
- PIN 12: red/blue

- 1 \_\_\_\_\_
- 2 \_\_\_\_\_
- 3 \_\_\_\_\_
- 4 \_\_\_\_\_
- 5 \_\_\_\_\_
- 6 \_\_\_\_\_
- 7 \_\_\_\_\_
- 8 \_\_\_\_\_
- 9 \_\_\_\_\_
- 10 \_\_\_\_\_
- 11 \_\_\_\_\_
- 12 \_\_\_\_\_

Max. supply voltage AC $U_B$	30 V	30 V
Max. supply voltage DC $U_B$	30 V	30 V
Number of conductors x conductor cross-section	12x0.25 mm <sup>2</sup>	12x0.25 mm <sup>2</sup>
Degree of protection as per IEC 60529	IP 67	IP 67
Ambient temperature $T_a$	-25...+85 °C	-25...+85 °C

Cable length	Ordering code	
	Part number	
0.5 m	<b>BCC0E59</b>	<b>BCC0E5C</b>
	BCC M45C-0000-1A-RM081-005	BCC M45C-0000-2A-RM081-005
2 m	<b>BCC0E5A</b>	<b>BCC0E5E</b>
	BCC M45C-0000-1A-RM081-020	BCC M45C-0000-2A-RM081-020

Other cable lengths on request.

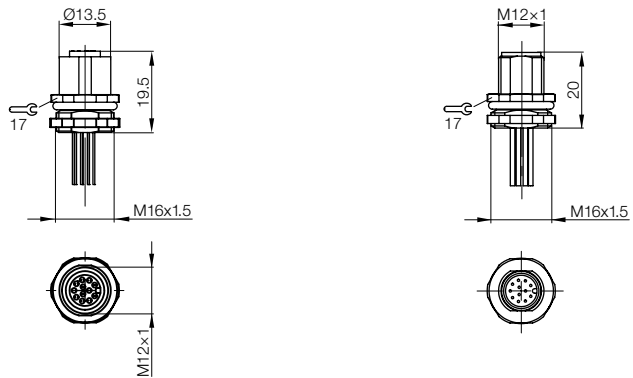

# Connectors

## Tees M12 ↔ M8, M12 ↔ M12 Adapter M12 ↔ M8



Connector diagram and wiring			
<b>Ordering code</b>	<b>BCC09JC</b>	<b>BCC089P</b>	<b>BCC09MU</b>
Part number	BCC M415-M313-M313-U0014-000	BCC M415-M415-M415-U0003-000	BCC M415-M415-M415-U0016-000
Supply voltage $U_B$	60 V	125 V	125 V
Rated operating current $I_e$	4 A	4 A	4 A
Degree of protection as per IEC 60529	IP 67	IP 67	IP 67
Ambient temperature $T_a$	-25...+85 °C	-25...+85 °C	-25...+85 °C
Housing material	PA 6.6 + GF	PA 6.6 + GF	PA 6.6 + GF

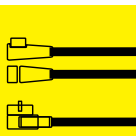
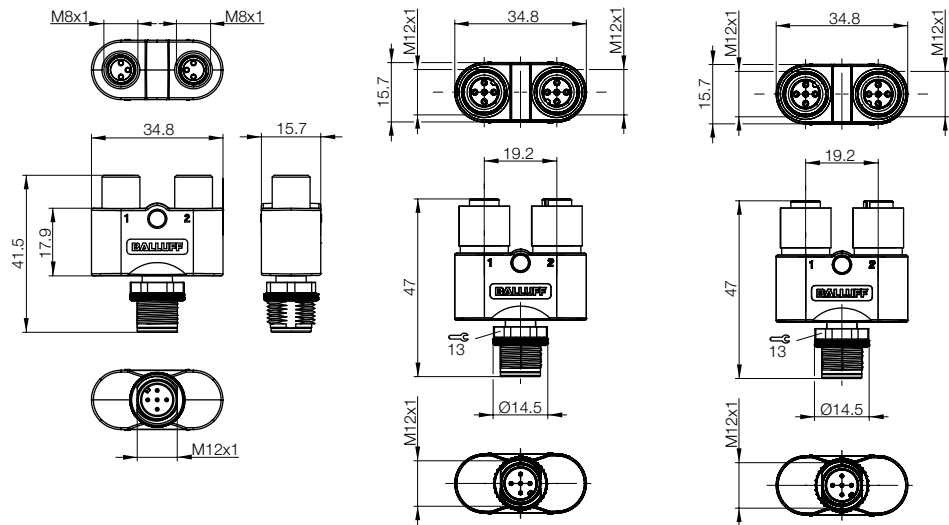

- Connectors and cables
- Connectors M5
- Connection cables M5↔M8
- Connectors M8
- Connection cables M8↔M8
- Connection cables M8↔M12
- Connectors M12**
- Connection cables M12↔M8
- Connection cables M12↔M12
- Tees, adapters**
- Y-connectors
- Accessories
- Special properties



Connector diagram and wiring

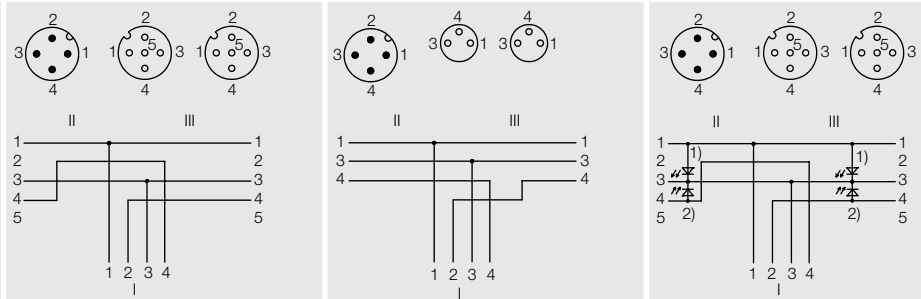

Version	2x M12 straight/M12	2x M8 straight/M12	2x M12 right-angle/M12
Max. supply voltage AC $U_B$	250 V AC	60 V AC	30 V DC
Max. supply voltage DC $U_B$	250 V DC	60 V DC	30 V DC
Cable	Molded-in	Molded-in	Molded-in
No. of conductors x conductor cross-section	4x0.34 mm <sup>2</sup>	4x0.34 mm <sup>2</sup>	4x0.34 mm <sup>2</sup>
Degree of protection as per IEC 60529	IP 68	IP 68	IP 68
Ambient temperature $T_a$	-40...+90 °C (UL 80 °C)	-40...+90 °C (UL 80 °C)	-40...+90 °C (UL 80 °C)
Static PUR	-25...+90 °C (UL 80 °C)	-25...+90 °C (UL 80 °C)	-25...+90 °C (UL 80 °C)
Tensioned PUR			

Length	Ordering code		
	Part number		
0.3 m	<b>BCC0AUA</b>		<b>BCC0C9U</b>
	BCC M414-M415-M415-U2028-003		BCC M414-M425-M425-U2034-003
0.6 m	<b>BCC0AUC</b>	<b>BCC0AFW</b>	<b>BCC0C9T</b>
	BCC M414-M415-M415-U2028-006	BCC M414-M313-M313-U2026-006	BCC M414-M425-M425-U2034-006
1 m	<b>BCC0AUE</b>	<b>BCC0AFY</b>	<b>BCC0C9R</b>
	BCC M414-M415-M415-U2028-010	BCC M414-M313-M313-U2026-010	BCC M414-M425-M425-U2034-010
2 m	<b>BCC0AUF</b>	<b>BCC0AFZ</b>	<b>BCC0C9P</b>
	BCC M414-M415-M415-U2028-020	BCC M414-M313-M313-U2026-020	BCC M414-M425-M425-U2034-020
3 m	<b>BCC0AUH</b>	<b>BCC0AH0</b>	<b>BCC0C9N</b>
	BCC M414-M415-M415-U2028-030	BCC M414-M313-M313-U2026-030	BCC M414-M425-M425-U2034-030

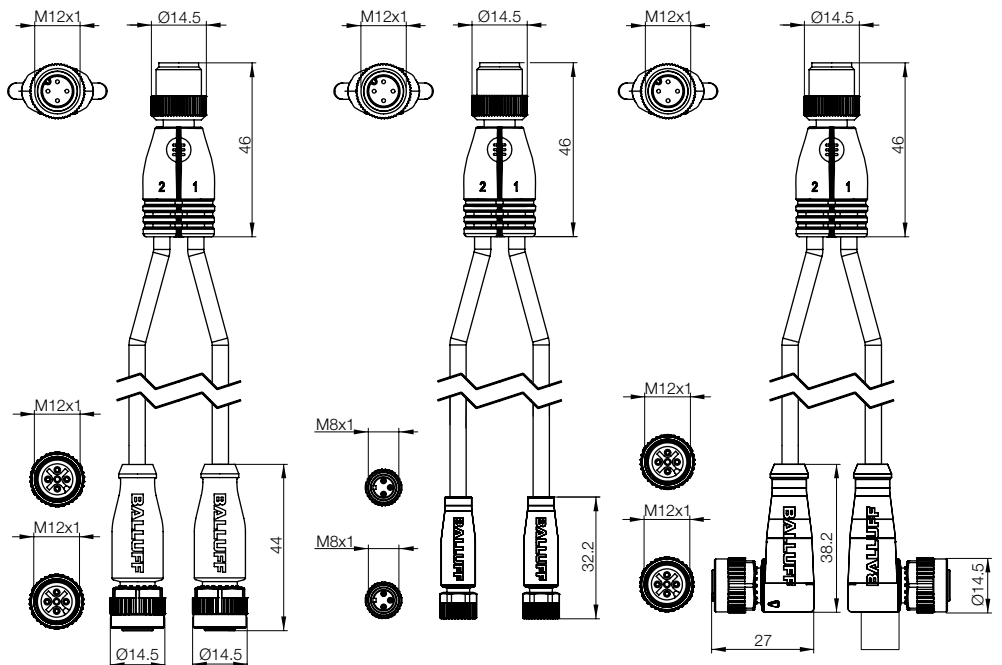



# Connectors and Cables Accessories

For large quantities or torque adjustments.



Description	Torque	Ordering code
		Part number
Torque wrench for M8	0.4 Nm	<b>BAM00ZL</b> BAM TO-CC-001-M3-0.4/8.0
Torque wrench for M12	0.6 Nm	<b>BAM00ZM</b> BAM TO-CC-001-M4-0.6/12.0
Torque wrench for 7/8"	1.5 Nm	<b>BAM00ZN</b> BAM TO-CC-001-A3-1.5/24.0



## Assembly wrench

User-fabricated M23 connectors are easy to assemble due to their size. After the components are assembled, the top and bottom section must be secured to one another to guarantee the high degree of protection.



Description	Ordering code
	Part number
Assembly wrench for 12 and 19-pin M23 connectors	<b>BAM01TY</b> BAM TO-CC-002-M6

## Marking sleeve



Description	Ordering code
	Part number
For labeling connectors	<b>BAM IA-CC-002-01</b>

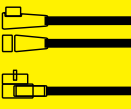

Connectors and cables

Connectors M5

Connection cables M5↔M8

Connectors M8

Connection cables M8↔M8

Connection cables M8↔M12

Connectors M12

Connection cables M12↔M8

Connection cables M12↔M12

Tees, adapters

**Y-connectors**

**Accessories**

Special properties

## Connectors

**M8 female straight, 3-pin, without LED,  
for temperatures up to 120 °C****Connector BCC up to 120 °C**

The durable connectors BCC with IP 68 protection are ideally matched to the wiring and suitable for rapid connection of sensors/actuators in the industrial automation sector. New products include versions for high-temperature applications up to 120 °C, for example, for the connection of high pressure-resistant sensors in hydraulic applications.

- Temperature range -25...+120 °C
- Degree of protection IP 68
- Flame-resistant
- Straight and right-angle
- 3-pin, 4-pin
- Easy to find notches on the handle body

120 °C

High  
Temperature



Connector diagram and wiring		
Max. supply voltage AC $U_B$	250 V AC	
Max. supply voltage DC $U_B$	250 V DC	
Cable	Molded	
Number of conductors × conductor cross-section	3×0.34 mm <sup>2</sup>	
Degree of protection as per IEC 60529	IP 67	
Ambient temperature $T_a$	<b>-25...+120 °C</b>	
Use	Normally open (NO) $\checkmark$ -	

Cable material	Color	Length	Ordering code	
			Part number	
PUR	Black	2 m		
PUR	Black	5 m	<b>BCC0836</b>	
PUR	Black	10 m	BCC M313-0000-10-001-PH0334-050	

Other cable materials, colors and lengths on request.

Connectors without LED are suitable for PNP and NPN switching functions. NPN versions with LED on request.

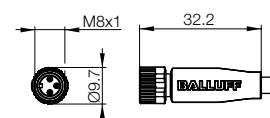

# M12

## Connectors

**M12 female straight and right-angle, 3 and 4-pin, without LED, for temperatures up to 120 °C**



PIN 1: brown  
PIN 3: blue  
PIN 4: black

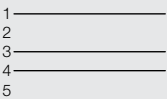

250 V AC  
250 V DC

Molded  
3x0.34 mm<sup>2</sup>  
IP 68

**-25...+120 °C**

Normally open  
(NO)  $\swarrow$ -



PIN 1: brown  
PIN 3: blue  
PIN 4: black

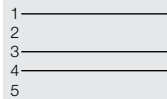

250 V AC  
250 V DC

Molded  
3x0.34 mm<sup>2</sup>  
IP 68

**-25...+120 °C**

Normally open  
(NO)  $\swarrow$ -



PIN 1: brown  
PIN 2: white  
PIN 3: blue  
PIN 4: black

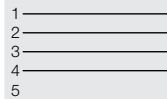

250 V AC  
250 V DC

Molded  
4x0.34 mm<sup>2</sup>  
IP 68

**-25...+120 °C**

Complementary  
(NO/NC)  $\swarrow$ -/ $\swarrow$ -



PIN 1: brown  
PIN 2: white  
PIN 3: blue  
PIN 4: black

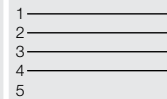

250 V AC  
250 V DC

Molded  
4x0.34 mm<sup>2</sup>  
IP 68

**-25...+120 °C**

Complementary  
(NO/NC)  $\swarrow$ -/ $\swarrow$ -

### Ordering code

Part number

**BCC082W**

BCC M415-0000-1A-001-PH0334-020

**BCC0832**

BCC M425-0000-1A-001-PH0334-020

**BCC0AA9**

BCC M415-0000-1A-003-PH0434-020

**BCC0AAE**

BCC M425-0000-1A-003-PH0434-020

**BCC082Y**

BCC M415-0000-1A-001-PH0334-050

**BCC0833**

BCC M425-0000-1A-001-PH0334-050

**BCC0AAA**

BCC M415-0000-1A-003-PH0434-050

**BCC0AAF**

BCC M425-0000-1A-003-PH0434-050

**BCC082Z**

BCC M415-0000-1A-001-PH0334-100

**BCC0AA8**

BCC M425-0000-1A-001-PH0334-100

**BCC0AAC**

BCC M415-0000-1A-003-PH0434-100

**BCC0AAH**

BCC M425-0000-1A-003-PH0434-100

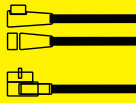
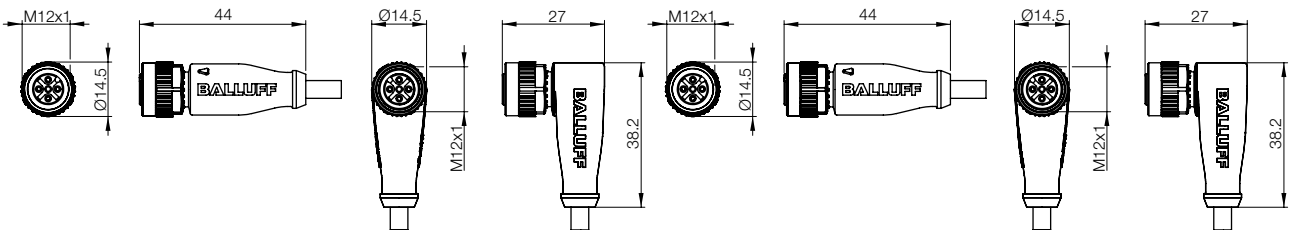

Connectors and cables

Special properties

**High-temperature resistant**

IP69 K-ECOLAB

Weld splatter-resistant

PUR lines

Y-connectors, weld splatter-resistant

Pottable connectors

Pottable connectors

# Connectors

# M8/M12

## M8 female right-angle, 3-pin, with LED M12 female right-angle, 3-pin, with LED IP 69K-ECOLAB

IP 69K

H<sub>2</sub>O<sub>2</sub> resistant  
ECOLAB



Connector diagram and wiring	 <sup>1)</sup> Green LED = Power <sup>2)</sup> Yellow LED = Function	 <sup>1)</sup> Green LED = Power <sup>2)</sup> Yellow LED = Function	
Max. supply voltage AC U <sub>B</sub>			
Max. supply voltage DC U <sub>B</sub>	30 V DC	30 V DC	
Cable	Molded	Molded	
Number of conductors × conductor cross-section	3×0.34 mm <sup>2</sup>	3×0.34 mm <sup>2</sup>	
<b>Degree of protection as per IEC 60529</b>	<b>IP 69K</b>	<b>IP 69K</b>	
Ambient temperature T <sub>a</sub>	PUR -40...+90 °C/-25...+90 °C (UL 80° C)	PVC -40...+90 °C/-25...+90 °C (UL 80° C)	
Static/moving	PVC -40...+105 °C/-5...+105 °C (UL 80° C)	PVC -40...+105 °C/-5...+105 °C (UL 80° C)	
Use	PNP	PNP normally open (NO)	
LED	Green/yellow	Green/yellow	

Cable material	Color	Length	Ordering code	
			Part number	
PUR	Black	2 m	<b>BCC08CZ</b> BCC S323-0000-10-004-PX0334-020	<b>BCC08CM</b> BCC S425-0000-1A-004-PX0334-020
PUR	Black	3 m	<b>BCC0A2F</b> BCC S323-0000-10-004-PX0334-030	<b>BCC08CN</b> BCC S425-0000-1A-004-PX0334-030
PUR	Black	5 m	<b>BCC08E0</b> BCC S323-0000-10-004-PX0334-050	<b>BCC08CP</b> BCC S425-0000-1A-004-PX0334-050
PUR	Black	10 m	<b>BCC0A2H</b> BCC S323-0000-10-004-PX0334-100	<b>BCC08CR</b> BCC S425-0000-1A-004-PX0334-100
PUR	Black	15 m		<b>BCC06UE</b> BCC S425-0000-1A-004-PX0334-150
PUR	Black	20 m		<b>BCC06UF</b> BCC S425-0000-1A-004-PX0334-200
PUR	Black	25 m		<b>BCC06UH</b> BCC S425-0000-1A-004-PX0334-250
PUR	Black	40 m		<b>BCC06UJ</b> BCC S425-0000-1A-004-PX0334-400
PVC	gray, black	5 m		<b>BCC0A2L</b> BCC S425-0000-1A-004-VX8334-050
PVC	gray, black	10 m		<b>BCC0A2M</b> BCC S425-0000-1A-004-VX8334-100
PVC	gray, black	15 m		<b>BCC06U9</b> BCC S425-0000-1A-004-VX8334-150
PVC	gray, black	20 m		<b>BCC06UA</b> BCC S425-0000-1A-004-VX8334-200
PVC	gray, black	25 m		<b>BCC06UC</b> BCC S425-0000-1A-004-VX8334-250
PVC	Gray	30 m		
PVC	Gray	35 m		

Other cable materials, colors, and lengths on request.

Connectors without LED are suitable for PNP and NPN switching functions. NPN versions on request.

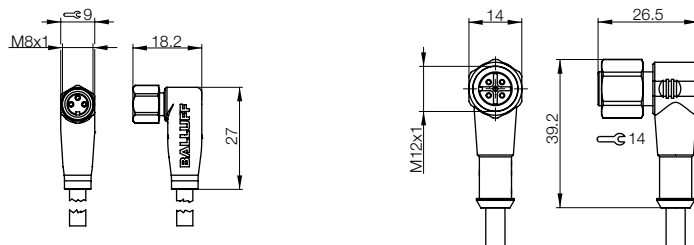

# M12

## Connectors

### M12 female straight and right-angle, 4-pin, with and without LED IP 69K-ECOLAB

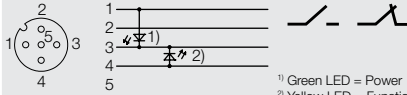
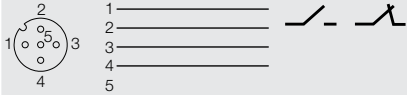

250 V AC
250 V DC
Molded
4x0.34 mm <sup>2</sup>
<b>IP 69K</b>
-40...+90 °C/-25...+90 °C (UL 80° C)
-40...+105 °C/-5...+105 °C (UL 80° C)
Complementary (NO/NC) $\swarrow$ -/ $\searrow$

250 V AC
250 V DC
Molded
4x0.34 mm <sup>2</sup>
<b>IP 69K</b>
-40...+90 °C/-25...+90 °C (UL 80° C)
-40...+105 °C/-5...+105 °C (UL 80° C)
Complementary (NO/NC) $\swarrow$ -/ $\searrow$

30 V DC
Molded
4x0.34 mm <sup>2</sup>
<b>IP 69K</b>
-40...+90 °C/-25...+90 °C (UL 80° C)
-40...+105 °C/-5...+105 °C (UL 80° C)
PNP complementary (NO/NC) $\swarrow$ -/ $\searrow$
Green/yellow

#### Ordering code

Part number	
	<b>BCC08CU</b> BCC S425-0000-1A-008-PX0434-050
	<b>BCC0A2K</b> BCC S425-0000-1A-008-PX0434-100
	<b>BCC0CTE</b> BCC S425-0000-1A-008-VX0434-050
<b>BCC06M7</b> BCC S415-0000-1A-003-VX8434-100	<b>BCC06MF</b> BCC S425-0000-1A-003-VX8434-100
<b>BCC06M8</b> BCC S415-0000-1A-003-VX8434-150	<b>BCC06MH</b> BCC S425-0000-1A-003-VX8434-150
<b>BCC06M9</b> BCC S415-0000-1A-003-VX8434-200	<b>BCC06MJ</b> BCC S425-0000-1A-003-VX8434-200
<b>BCC06MA</b> BCC S415-0000-1A-003-VX8434-250	<b>BCC06MK</b> BCC S425-0000-1A-003-VX8434-250
<b>BCC06MC</b> BCC S415-0000-1A-003-VX8434-300	<b>BCC06ML</b> BCC S425-0000-1A-003-VX8434-300
<b>BCC06ME</b> BCC S415-0000-1A-003-VX8434-350	<b>BCC06MM</b> BCC S425-0000-1A-003-VX8434-350

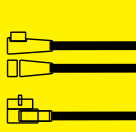

- Connectors and cables
- Special properties
- High-temperature resistant
- IP69 K-ECOLAB**
- Weld splatter-resistant
- PUR lines
- Y-connectors, weld splatter-resistant
- Pottable connectors

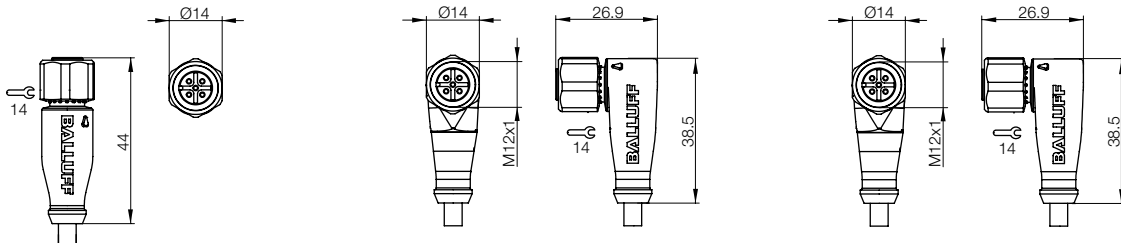

# Connectors

## Weld splatter-resistant PUR lines

### PUR lines for especially tough conditions

Standard PUR lines have numerous advantages. They are resilient, wear-resistant, impact-resistant and resistant against solvents. With the new weld splatter-resistant versions to ISO 14001, you can easily replace crosslinked cables that become expensive hazardous waste after use. Possible field of applications include automobile manufacturing, in particular, bodyshell work.

- Resistant to sparks and weld spatter
- Degree of protection IP 68
- ISO 14001 compliant – not hazardous waste
- Replacement for crosslinked lines
- Jacket color: Black
- Torsional stress 180 °C
- Fulfill all requirements of the automotive industry



Connector diagram and wiring	
Max. supply voltage AC $U_B$	
Max. supply voltage DC $U_B$	
Cable	
Number of conductors × conductor cross-section	
Degree of protection as per IEC 60529	
Ambient temperature $T_a$	Static
	Tensioned

Cable material	Color	Length
PUR	Black	5 m
PUR	Black	10 m

Other cable materials, colors and lengths on request.  
 Connectors without LED are suitable for PNP and NPN switching functions. NPN versions with LED on request.

# Connectors

## M8 female, 3- and 4-pin, without LED

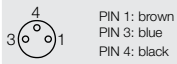

PIN 1: brown  
PIN 3: blue  
PIN 4: black

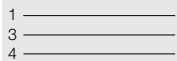

PIN 1: brown  
PIN 3: blue  
PIN 4: black

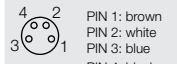
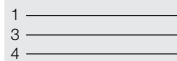

PIN 1: brown  
PIN 2: white  
PIN 3: blue  
PIN 4: black



PIN 1: brown  
PIN 2: white  
PIN 3: blue  
PIN 4: black

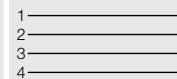

60 V AC  
60 V DC  
Molded  
3x0.34 mm<sup>2</sup>  
IP 67  
-25...+80 °C  
-25...+80 °C

60 V AC  
60 V DC  
Molded  
3x0.34 mm<sup>2</sup>  
IP 67  
-25...+80 °C  
-25...+80 °C

60 V AC  
60 V DC  
Molded  
3x0.34 mm<sup>2</sup>  
IP 67  
-25...+80 °C  
-25...+80 °C

60 V AC  
60 V DC  
Molded  
4x0.34 mm<sup>2</sup>  
IP 68  
-25...+80 °C  
-25...+80 °C

### Ordering code

Part number

**BCC0AJK**

BCC M313-0000-10-001-PW0334-050

**BCC0AJR**

BCC M323-0000-10-001-PW0334-050

**BCC0AJM**

BCC M314-0000-10-003-PW0434-050

**BCC0AJW**

BCC M324-0000-10-003-PW0434-050

**BCC0CAP**

BCC M313-0000-10-001-PW0334-100

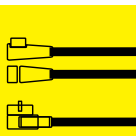
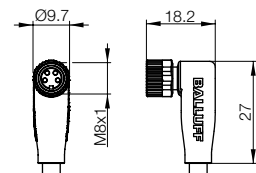
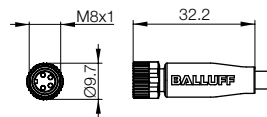
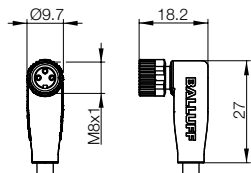
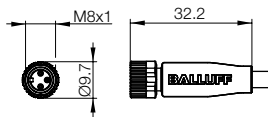

Connectors and cables

Special properties

High-temperature resistant

IP69 K-ECOLAB

Weld splatter-resistant

PUR lines

Y-connectors, weld splatter-resistant

Pottable connectors

Pottable connectors

Pottable connectors



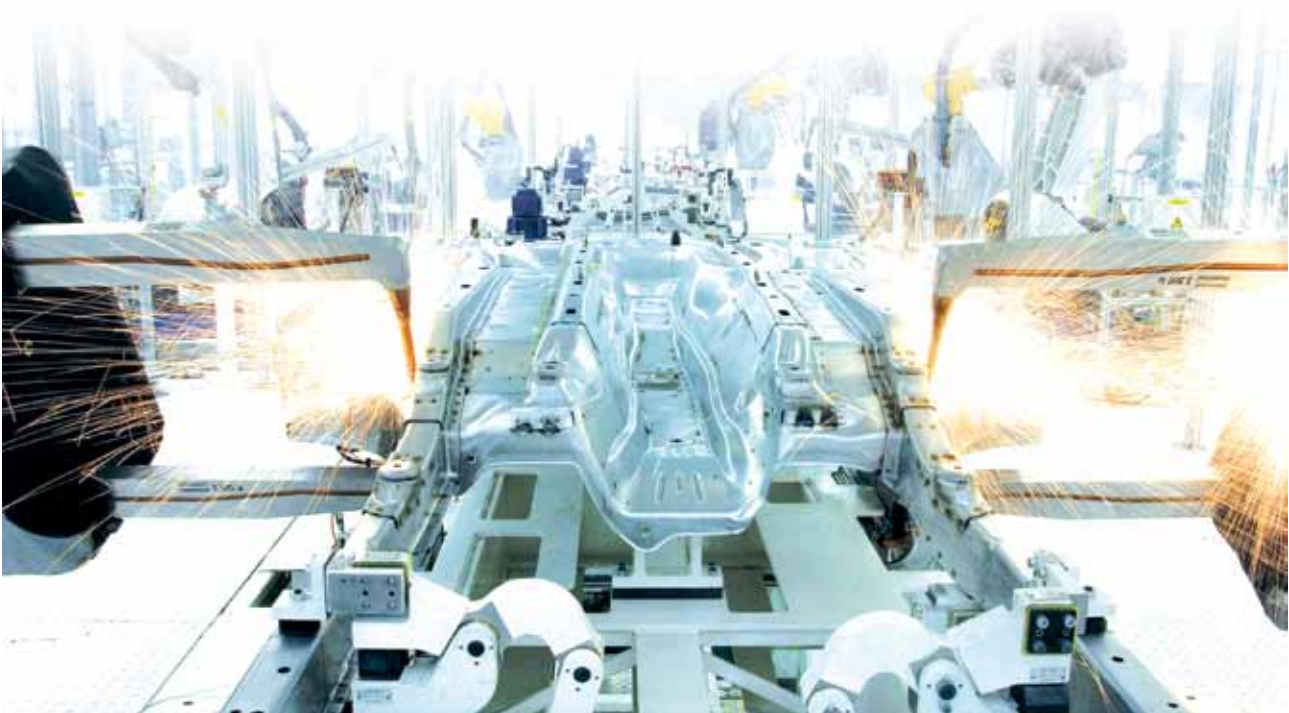



# Connectors

## M12 female, 4-pin, no LED



Connector diagram and wiring	<p>PIN 1: brown PIN 2: white PIN 3: blue PIN 4: black</p>	<p>PIN 1: brown PIN 2: white PIN 3: blue PIN 4: black</p>	
Max. supply voltage AC $U_B$	250 V AC	250 V AC	
Max. supply voltage DC $U_B$	250 V DC	250 V DC	
Cable	Molded	Molded	
No. of conductors × conductor cross-section	4×0.34 mm <sup>2</sup>	4×0.34 mm <sup>2</sup>	
Degree of protection as per IEC 60529	IP 68	IP 68	
Ambient temperature $T_a$	Static: -40...+80 °C Tensioned: -25...+80 °C	-40...+80 °C -25...+80 °C	
Use	Complementary (NO/NC)	Complementary (NO/NC)	

Cable material	Color	Length	Ordering code	Part number	
PUR	Black	2 m	<b>BCC0AK4</b>		
			BCC M415-0000-1A-003-PW0434-020		
PUR	Black	5 m	<b>BCC0AK5</b>	<b>BCC0AKE</b>	
			BCC M415-0000-1A-003-PW0434-050	BCC M425-0000-1A-003-PW0434-050	
PUR	Black	10 m	<b>BCC0AK6</b>	<b>BCC0AKF</b>	
			BCC M415-0000-1A-003-PW0434-100	BCC M425-0000-1A-003-PW0434-100	

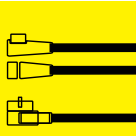

Connectors and cables  
Special properties  
High-temperature resistant  
IP69 K-ECOLAB  
Weld splatter-resistant  
PUR lines  
Y-connectors, weld splatter-resistant  
Pottable connectors

Other cable lengths on request.  
Connectors without LED are suitable for PNP and NPN switching functions. NPN versions with LED on request.

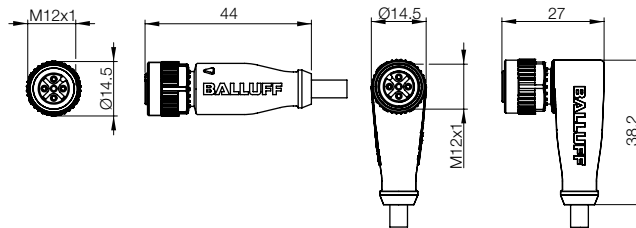

# Connection Cables

# M12 ↔ M12

## Weld splatter-resistant PUR lines

### M12 female straight or right-angle ↔ M12 male straight, 4-pin, without and with LED



Connector diagram and wiring			
Max. supply voltage AC $U_B$	250 V AC	250 V AC	30 V DC
Max. supply voltage DC $U_B$	250 V DC	250 V DC	30 V DC
Cable	Molded	Molded	Molded
Number of conductors × conductor cross-section	4×0.34 mm <sup>2</sup>	4×0.34 mm <sup>2</sup>	4×0.34 mm <sup>2</sup>
Degree of protection as per IEC 60529	IP 68	IP 68	IP 68
Ambient temperature $T_a$	Static: -40...+80 °C Tensioned: -25...+80 °C	-40...+80 °C	-25...+80 °C / -25...+80 °C
Use	Complementary (NO/NC)	Complementary (NO/NC)	Complementary (NO/NC)
LED, transparent head			Green LED = Power Yellow LED = Switching output White LED = Switching output

Cable material	Color	Length	Ordering code	Part number
PUR	Black	0.3 m	<b>BCC0AP1</b>	<b>BCC0ANP</b>
PUR	Black	0.6 m	<b>BCC0AP2</b>	<b>BCC0ANR</b>
PUR	Black	1 m	<b>BCC0AP3</b>	<b>BCC0ANT</b>
PUR	Black	1.5 m	<b>BCC0AP4</b>	<b>BCC0ANU</b>
PUR	Black	2 m	<b>BCC0AP5</b>	<b>BCC0ANW</b>
PUR	Black	3 m		
PUR	Black	5 m	<b>BCC0AP7</b>	<b>BCC0ANZ</b>
			BCC M415-M414-3A-304-PW0434-050	BCC M425-M414-3A-304-PW0434-050
				BCC M425-M414-3A-650-PW0434-050

Other cable lengths on request. Connectors without LED are suitable for PNP and NPN switching functions. NPN versions with LED on request.

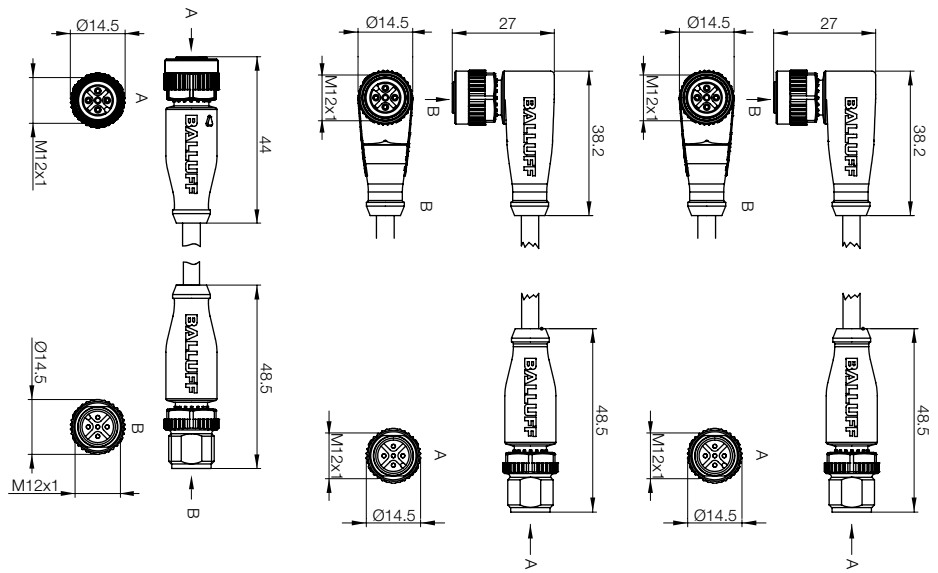

# Connection Cables

## Weld splatter-resistant PUR lines

M12 female straight or right-angle ↔

M12 male straight, 5-pin, with and without LED



Diagram 1	Diagram 2	Diagram 3	Diagram 4
<p>1 2 3 4</p> <p>1 2 3 4 5</p>	<p>1 2 3 4</p> <p>1 2 3 4 5</p>	<p>1 2 3 4</p> <p>1 2 3 4 5</p> <p>1<sup>1</sup> Green LED = Power 2<sup>2</sup> Yellow LED = Switching output 3<sup>3</sup> White LED = Switching output</p>	<p>1 2 3 4</p> <p>1 2 3 4 5</p>
125 V AC 125 V DC Molded 5×0.34 mm <sup>2</sup> IP 68 -40...+80 °C -25...+80 °C Complementary (NO/NC) ✓/-/✗	125 V AC 125 V DC Molded 5×0.34 mm <sup>2</sup> IP 68 -40...+80 °C -25...+80 °C Complementary (NO/NC) ✓/-/✗	30 V DC Molded 5×0.34 mm <sup>2</sup> IP 68 -25...+80 °C/-25...+80 °C -25...+80 °C/-5...+80 °C Complementary (NO/NC) ✓/-/✗ Green/yellow/white	250 V AC 250 V DC Molded 3×0.34 mm <sup>2</sup> IP 67 -40...+80 °C -25...+80 °C

Ordering code		Ordering code	
Part number		Part number	
			<b>BCC0AK1</b> BCC M414-M415-M415-U2027-003
<b>BCC0AJJ</b> (M)	<b>BCC0AKH</b> (M)	<b>BCC0C0N</b> (M)	<b>BCC0AK2</b> BCC M414-M415-M415-U2027-006
BCC M415-M415-3A-313-PW0534-006	BCC M425-M415-3A-313-PW0534-006	BCC M425-M415-3A-661-PW0534-006	<b>BCC0AK3</b> BCC M414-M415-M415-U2027-010
<b>BCC0AK7</b> (M)	<b>BCC0AKJ</b> (M)	<b>BCC0C0P</b> (M)	
BCC M415-M415-3A-313-PW0534-010	BCC M425-M415-3A-313-PW0534-010	BCC M425-M415-3A-661-PW0534-010	
<b>BCC0C0M</b> (M)		<b>BCC0C0R</b> (M)	
BCC M415-M415-3A-313-PW0534-015		BCC M425-M415-3A-661-PW0534-015	
<b>BCC0AK8</b> (M)	<b>BCC0AKK</b> (M)	<b>BCC0C0T</b> (M)	<b>BCC0C27</b> BCC M414-M415-M415-U2027-020
BCC M415-M415-3A-313-PW0534-020	BCC M425-M415-3A-313-PW0534-020	BCC M425-M415-3A-661-PW0534-020	
<b>BCC0AK9</b> (M)	<b>BCC0AKL</b> (M)	<b>BCC0C0U</b> (M)	
BCC M415-M415-3A-313-PW0534-030	BCC M425-M415-3A-313-PW0534-030	BCC M425-M415-3A-661-PW0534-030	
<b>BCC0AKA</b> (M)	<b>BCC0AKM</b> (M)	<b>BCC0C0W</b> (M)	
BCC M415-M415-3A-313-PW0534-050	BCC M425-M415-3A-313-PW0534-050	BCC M425-M415-3A-661-PW0534-050	

Connectors and cables  
Special properties  
High-temperature resistant  
IP69 K-ECOLAB  
Weld splatter-resistant PUR lines  
Y-connectors, weld splatter-resistant  
Pottable connectors

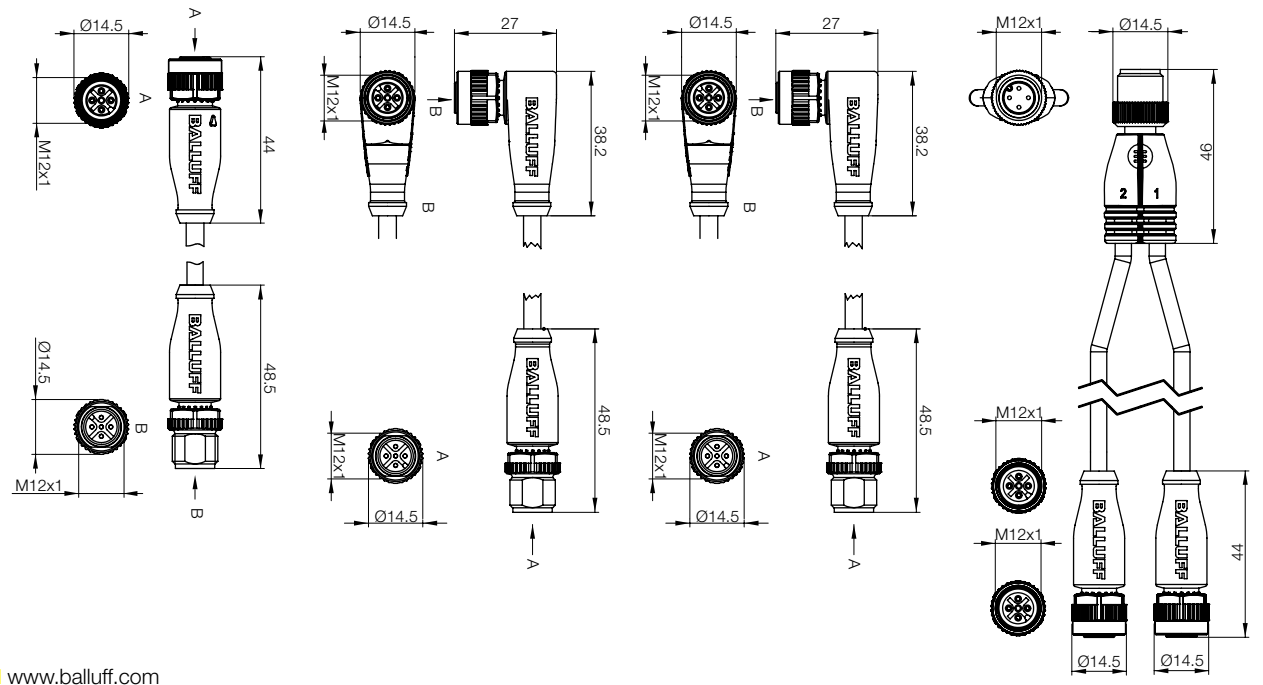

**Weld splatter-resistant PUR lines****PUR lines for especially tough conditions**

Standard PUR lines have numerous advantages. They are resilient, wear-resistant, impact-resistant and resistant against solvents. With the new weld splatter-resistant versions to ISO 14001, you can easily replace crosslinked cables that become expensive hazardous waste after use. Possible field of applications include automobile manufacturing, in particular, bodyshell work.

- Resistant to sparks and weld spatter
- Degree of protection IP 67 and IP 68
- ISO 14001 compliant – not hazardous waste
- Replacement for crosslinked lines
- Jacket color: Orange
- Torsional stress 180 °C
- Fulfill all requirements of the automotive industry

Connector diagram and wiring

Max. supply voltage AC  $U_B$

Max. supply voltage DC  $U_B$

Cable

Number of conductors × conductor cross-section

Degree of protection as per IEC 60529

Ambient temperature  $T_a$

Static Tensioned Use

Cable material	Color	Length
PUR	Orange	5 m

Other cable lengths on request.  
Connectors without LED are suitable for PNP and NPN switching functions. NPN versions with LED on request.



# Connectors

## Weld splatter-resistant PUR lines M8 female straight and right-angle, 3- and 4-pin, without LED

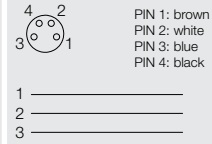
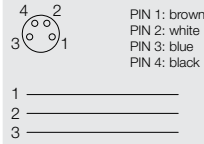
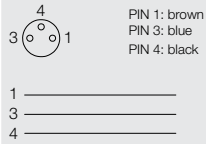
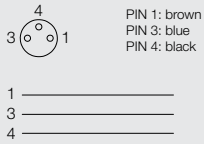

60 V AC
60 V DC
Molded
3x0.34 mm <sup>2</sup>
IP 67
-25...+80 °C
-25...+80 °C
Normally open (NO) -/-

60 V AC
60 V DC
Molded
3x0.34 mm <sup>2</sup>
IP 67
-25...+80 °C
-25...+80 °C
Normally open (NO) -/-

30 V AC
30 V DC
Molded
4x0.34 mm <sup>2</sup>
IP 67
-25...+80 °C
-25...+80 °C
Complementary (NO/NC) -/-/—

30 V AC
30 V DC
Molded
4x0.34 mm <sup>2</sup>
IP 67
-25...+80 °C
-25...+80 °C
Complementary (NO/NC) -/-/—

### Ordering code

Part number

**BCC0C3A**

BCC M313-0000-10-001-PW3334-050

**BCC0C24**

BCC M323-0000-10-001-PW3334-050

**BCC0C21**

BCC M314-0000-10-003-PW3434-050

**BCC0C20**

BCC M324-0000-10-003-PW3434-050

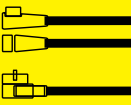
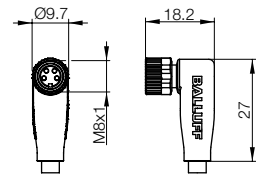
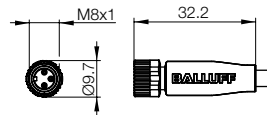
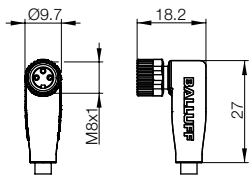
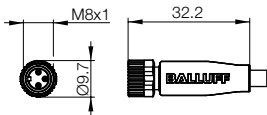

Connectors and cables  
Special properties  
High-temperature resistant  
IP69 K-ECOLAB  
**Weld splatter-resistant PUR lines**  
Y-connectors, weld splatter-resistant  
Portable connectors

## Weld splatter-resistant PUR lines M12 female straight and right-angle, 3- and 4-pin, with and without LED



Connector diagram and wiring	 PIN 1: brown PIN 3: blue PIN 4: black	 PIN 1: brown PIN 3: blue PIN 4: black	 PIN 1: brown PIN 2: white PIN 3: blue PIN 4: black
		 <sup>1)</sup> Green LED = Power <sup>2)</sup> Yellow LED = Switching output	
Max. supply voltage AC $U_B$	250 V AC	30 V DC	250 V AC
Max. supply voltage DC $U_B$	250 V DC		250 V DC
Cable	Molded	Molded	Molded
Number of conductors x conductor cross-section	3x0.34 mm <sup>2</sup>	3x0.34 mm <sup>2</sup>	4x0.34 mm <sup>2</sup>
Degree of protection as per IEC 60529	IP 68	IP 68	IP 68
Ambient temperature $T_a$	Static: -40...+80 °C Tensioned: -25...+80 °C	-40...+80 °C -25...+80 °C	-40...+80 °C -25...+80 °C
Use	Normally open (NO) ✓-	Normally open (NO) ✓-	Complementary (NO/NC) ✓-/✓-
LED, transparent head		Green/yellow	

Cable material	Color	Length	Ordering code	Part number
PUR	Orange	1.5 m		
PUR	Orange	2 m	<b>BCC086T</b>	<b>BCC09J8</b>
			BCC M425-0000-1A-001-PW3334-020	BCC M425-0000-1A-004-PW3334-020
PUR	Orange	5 m	<b>BCC086U</b>	<b>BCC08MZ</b>
			BCC M425-0000-1A-001-PW3334-050	BCC M425-0000-1A-004-PW3334-030
PUR	Orange	7.5 m		
PUR	Orange	10 m	<b>BCC086W</b>	<b>BCC08LE</b>
			BCC M425-0000-1A-001-PW3334-100	BCC M425-0000-1A-004-PW3334-100
				<b>BCC0C7W</b>
				BCC M415-0000-1A-003-PW3434-100

Other cable lengths on request. Connectors without LED are suitable for PNP and NPN switching functions. NPN versions with LED on request.

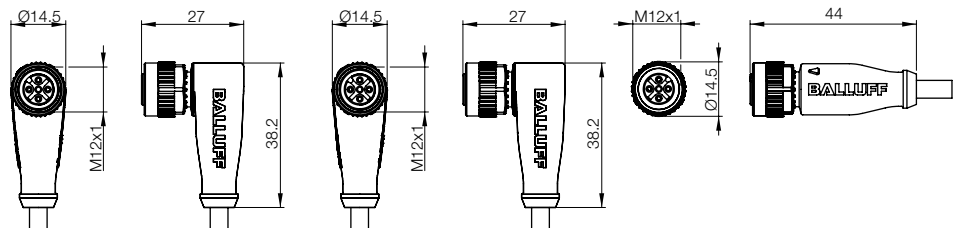

# Connectors

## Weld splatter-resistant PUR lines M12 female straight and right-angle, 4 and 5-pin, with and without LED



PIN 1: brown  
PIN 2: white  
PIN 3: blue  
PIN 4: black



PIN 1: brown  
PIN 2: white  
PIN 3: blue  
PIN 4: black

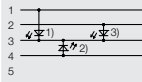

<sup>1</sup> Green LED = Power  
<sup>2</sup> Yellow LED = Switching output  
<sup>3</sup> White LED = Switching output



PIN 1: brown  
PIN 2: white  
PIN 3: blue  
PIN 4: black  
PIN 5: green/yellow



PIN 1: brown  
PIN 2: white  
PIN 3: blue  
PIN 4: black  
PIN 5: green/yellow

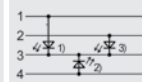

<sup>1</sup> Green LED = Power  
<sup>2</sup> Yellow LED = Switching output  
<sup>3</sup> White LED = Switching output

250 V AC

250 V DC

Molded

4x0.34 mm<sup>2</sup>

IP 68

-40...+80 °C

-25...+80 °C

Complementary (NO/NC)  $\swarrow$ -/ $\searrow$

30 V DC

Molded

4x0.34 mm<sup>2</sup>

IP 68

-40...+80 °C

-25...+80 °C

Complementary (NO/NC)  $\swarrow$ -/ $\searrow$

Green/yellow/white

125 V AC

125 V DC

Molded

5x0.34 mm<sup>2</sup>

IP 68

-40...+80 °C

-25...+80 °C

Complementary (NO/NC)  $\swarrow$ -/ $\searrow$

30 V DC

Molded

5x0.34 mm<sup>2</sup>

IP 68

-40...+80 °C

-25...+80 °C

Complementary (NO/NC)  $\swarrow$ -/ $\searrow$

Green/yellow/white

### Ordering code

Part number

**BCC087F**

BCC M415-0000-1A-034-PW3534-015

**BCC087L**

BCC M425-0000-1A-040-PW3534-015

**BCC0C3Z**

BCC M425-0000-1A-099-PW3434-020

**BCC0C22**

BCC M425-0000-1A-003-PW3434-050

**BCC0C41**

BCC M425-0000-1A-099-PW3434-050

**BCC087H**

BCC M415-0000-1A-034-PW3534-050

**BCC087M**

BCC M425-0000-1A-040-PW3534-050

**BCC087J**

BCC M415-0000-1A-034-PW3534-075

**BCC087N**

BCC M425-0000-1A-040-PW3534-075

**BCC0C42**

BCC M425-0000-1A-099-PW3434-100

**BCC087K**

BCC M415-0000-1A-034-PW3534-100

**BCC087P**

BCC M425-0000-1A-040-PW3534-100

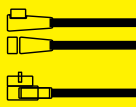
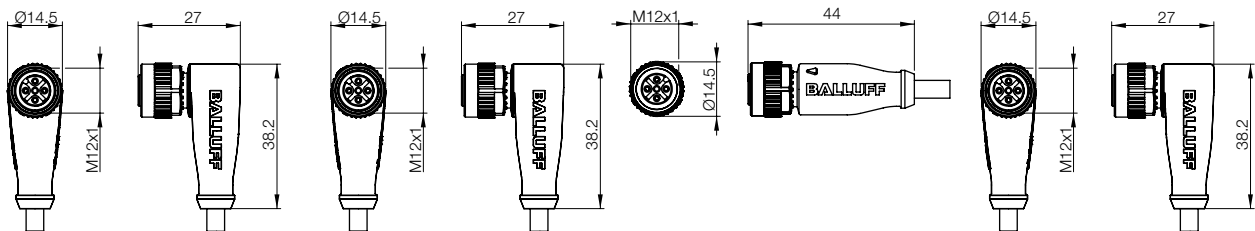

Connectors and cables  
Special properties  
High-temperature resistant  
IP69 K-ECOLAB  
Weld splatter-resistant PUR lines  
Y-connectors, weld splatter-resistant  
Pottable connectors

**Weld splatter-resistant PUR lines**  
**M12 female right-angle, 5-pin, with LED**



Connector diagram and wiring	<p>PIN 1: brown          PIN 2: white          PIN 3: blue          PIN 4: black          PIN 5: green/yellow</p> <p><sup>1</sup> Green LED = Power  <sup>2</sup> Yellow LED = Switching output  <sup>3</sup> Red LED = Switching output</p>		
Max. supply voltage AC U <sub>B</sub>			
Max. supply voltage DC U <sub>B</sub>		30 V DC	
Cable		Molded	
Number of conductors × conductor cross-section		5×0.34 mm <sup>2</sup>	
Degree of protection as per IEC 60529		IP 68	
Ambient temperature T <sub>a</sub>	PUR	-40...+80 °C	
	PVC	-25...+80 °C	
Use		Complementary (NO/NC)	
LED		green/yellow/red	

Cable material	Color	Length	Ordering code	Part number
PUR		Orange	0.3 m	
PUR		Orange	0.6 m	
PUR		Orange	1 m	
PUR		Orange	1.5 m	
PUR		Orange	2 m	<b>BCC0C7U</b> BCC M425-0000-1A-100-PW3534-020
PUR		Orange	3 m	
PUR		Orange	5 m	<b>BCC0C7T</b> BCC M425-0000-1A-100-PW3534-050
PUR		Orange	10 m	<b>BCC0C7U</b> BCC M425-0000-1A-100-PW3534-100

Other cable materials, colors, and lengths on request.  
 Connectors without LED are suitable for PNP and NPN switching functions.  
 NPN versions on request.

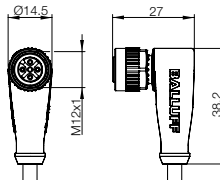



# Connection Cables

## Weld splatter-resistant PUR cables

M12 female straight or right-angle ↔ M12 male straight, 4 or 5-pin, with and without LED

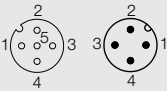

PIN 1: brown  
PIN 2: white  
PIN 3: blue  
PIN 4: black  
PIN 5: green/yellow

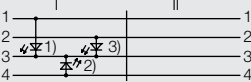

<sup>1</sup> Green LED = Power  
<sup>2</sup> Yellow LED = Switching output  
<sup>3</sup> Red LED = Switching output

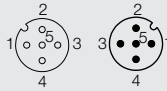

PIN 1: brown  
PIN 2: white  
PIN 3: blue  
PIN 4: black  
PIN 5: green/yellow

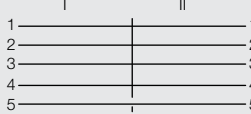

<sup>1</sup> Green LED = Power  
<sup>2</sup> Yellow LED = Switching output  
<sup>3</sup> Red LED = Switching output

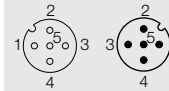

PIN 1: brown  
PIN 2: white  
PIN 3: blue  
PIN 4: black  
PIN 5: green/yellow

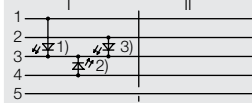

<sup>1</sup> Green LED = Power  
<sup>2</sup> Yellow LED = Switching output  
<sup>3</sup> Red LED = Switching output

30 V DC

Molded

4x0.34 mm<sup>2</sup>

IP 68

-40...+80 °C

-25...+80 °C

Complementary (NO/NC)  $\checkmark$  / - /  $\checkmark$   
green/yellow/red

30 V DC

Molded

5x0.34 mm<sup>2</sup>

IP 68

-40...+80 °C

-25...+80 °C

Complementary (NO/NC)  $\checkmark$  / - /  $\checkmark$

30 V DC

Molded

5x0.34 mm<sup>2</sup>

IP 68

-40...+80 °C

-25...+80 °C

Complementary (NO/NC)  $\checkmark$  / - /  $\checkmark$   
green/yellow/red

### Ordering code

Part number

#### BCC0C4K

BCC M425-M414-3A-691-PW3434-003

#### BCC0C52

BCC M425-M414-3A-691-PW3434-006

#### BCC0C4L

BCC M425-M414-3A-691-PW3434-010

#### BCC0C4M

BCC M425-M414-3A-691-PW3434-015

#### BCC0C4N

BCC M425-M414-3A-691-PW3434-020

#### BCC0C4P

BCC M425-M414-3A-691-PW3434-030

#### BCC0C4R

BCC M425-M414-3A-691-PW3434-050

#### BCC087R

BCC M415-M415-3A-313-PW3534-006

#### BCC087T

BCC M415-M415-3A-313-PW3534-010

#### BCC087U

BCC M415-M415-3A-313-PW3534-015

#### BCC087W

BCC M415-M415-3A-313-PW3534-020

#### BCC09M2

BCC M415-M415-3A-313-PW3534-030

#### BCC09M1

BCC M415-M415-3A-313-PW3534-050

#### BCC0C4T

BCC M425-M415-3A-692-PW3534-003

#### BCC0C4U

BCC M425-M415-3A-692-PW3534-006

#### BCC0C4W

BCC M425-M415-3A-692-PW3534-010

#### BCC0C4Y

BCC M425-M415-3A-692-PW3534-015

#### BCC0C4Z

BCC M425-M415-3A-692-PW3534-020

#### BCC0C50

BCC M425-M415-3A-692-PW3534-030

#### BCC0C51

BCC M425-M415-3A-692-PW3534-050

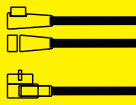
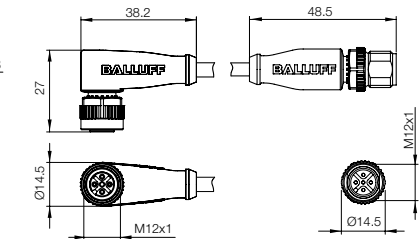
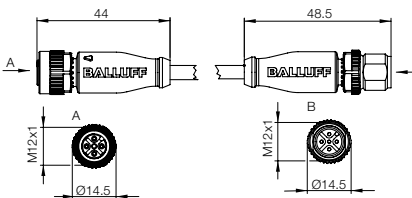
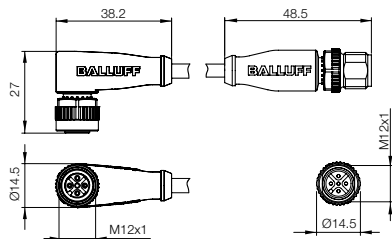

Connectors and cables

Special properties

High-temperature resistant

IP69 K-ECOLAB

Weld splatter-resistant PUR lines

Y-connectors, weld splatter-resistant

Pottable connectors



Connector diagram and wiring

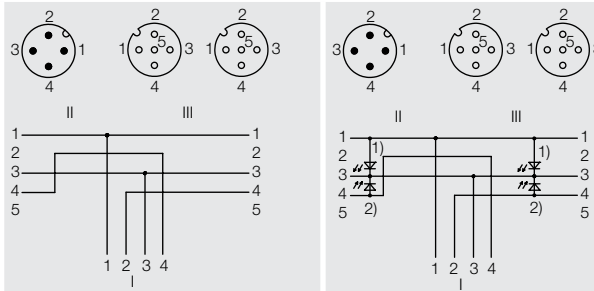

Max. supply voltage AC $U_B$	250 V AC		
Max. supply voltage DC $U_B$	250 V DC	30 V DC	
Cable	Molded	Molded	
Number of conductors x conductor cross-section	3x0.34 mm <sup>2</sup>	3x0.34 mm <sup>2</sup>	
Degree of protection as per IEC 60529	IP 67	IP 67	
Ambient temperature $T_a$	Static -40...+80 °C	-40...+80 °C	
	Tensioned -25...+80 °C	-25...+80 °C	
LED, transparent head		Green/yellow	

Cable material	Color	Length	Ordering code	
			Part number	
PUR	Orange	0.3 m	<b>BCC0C7A</b>	<b>BCC0CA2</b>
			BCC M414-M415-M415-U2032-003	BCC M414-M425-M425-U2035-003
PUR	Orange	0.6 m	<b>BCC0C7C</b>	<b>BCC0CA3</b>
			BCC M414-M415-M415-U2032-006	BCC M414-M425-M425-U2035-006
PUR	Orange	1 m	<b>BCC0C7E</b>	<b>BCC0CA4</b>
PUR	Orange	2 m	BCC M414-M415-M415-U2032-010	BCC M414-M425-M425-U2035-010
				<b>BCC0CA5</b>
PUR	Orange	3 m		BCC M414-M425-M425-U2035-020
				<b>BCC0CA6</b>
				BCC M414-M425-M425-U2035-030

Other cable lengths on request.  
Connectors without LED are suitable for PNP and NPN switching functions. NPN versions with LED on request.

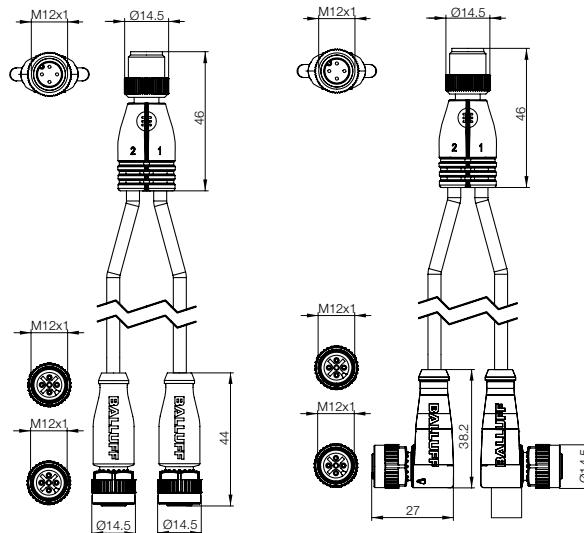

# Connectors

## M12 female right-angle, user-fabricated and pottable

### Hook up, seal, forget

Until now, you had a difficult choice when installing plug connectors. Either you could use a plug with a molded cable and in this manner achieve higher leakproofness, or you could decide in favor of an adjustable plug, if you need flexible cable length.

This either/or is now over. Because the adjustable and castable BCC0CAA plug provides both: higher leakproofness and flexible cable length. The cable is shortened, connected and the plug is easily molded (see drawing). With the BCC0CAA, you increase the reliability of your installation and simultaneously decide the cable length yourself.

In harsh environments and extensive systems, the plug is therefore outstandingly well suited.

### Features

- Higher leakproofness
- Flexible cable length
- Reliable
- For harsh environments
- For extensive systems



Connector diagram and wiring	<p>PIN 1-5 usable</p>
Connector	M12
Version	Can be fabricated
Use	Female
<b>Ordering code</b>	<b>BCC0CAA</b>
Part number	BCC S445-0000-1A-000-51X475-000-C024
Max. supply voltage AC $U_B$	125 V AC
Max. supply voltage DC $U_B$	125 V DC
Wire cross-section	0.14...0.75 mm <sup>2</sup>
Cable diameter	6...8 mm
Degree of protection as per IEC 60529	IP 67
Ambient temperature $T_a$	-25...+85 °C
Material	Grip body: PBT, transparent Contact: CuZn Contact holder: PA

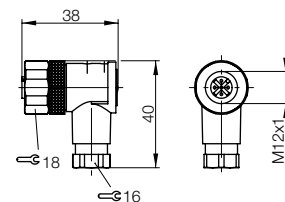
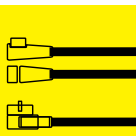

Connectors and cables  
Special properties  
High-temperature resistant  
IP69 K-ECOLAB  
Weld splatter-resistant  
PUR lines  
Y-connectors, weld splatter-resistant  
Pottable connectors

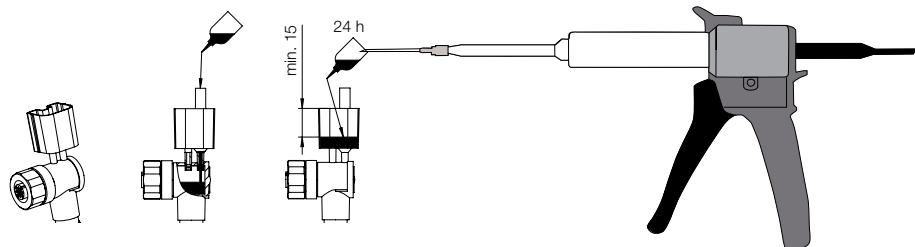

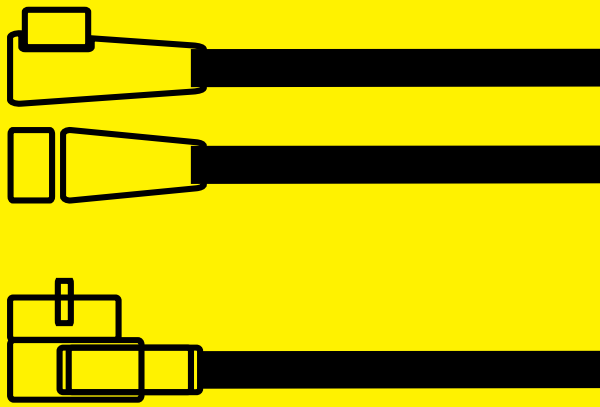

# Connectors and Valve Connectors



<b>Valve Connectors</b>	Style A	DIN	348
	Style B	DIN	350
	Style B	Industry	352
	Style C	DIN	354
	Style C	Industry	355
	Connectors for pressure switches		356

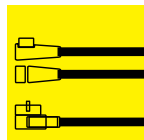

## Valve Connectors

From sensors to cables, Balluff offers extensive, well-engineered system technology that leaves nothing to be desired outside of the switching cabinet.

Balluff valve connectors have an outstanding record in harsh industrial use and adverse conditions. They withstand large temperature differences as well as heavy contamination and their integrated protective circuit effectively prevents voltage peaks. In addition, the drag-chain compatible PUR and PVC valve connectors are available only from Balluff.



Choose the EN 175301-compliant valve connectors for extra flexibility

- With or without protective circuit
- With 100% on-time at -25...+80 °C
- Various styles in accordance with DIN and industry standard
- Drag chain-compatible connections with PUR and PVC cable

# Valve Connectors

## Style A, DIN, 18 mm, 4-pin



Connector diagram and wiring	 PIN 1: black PIN 2: blue PIN PE: green/yellow	 PIN 1: black PIN 2: blue PIN PE: green/yellow
Cable outlet	<b>0°/180°</b>	<b>0°/180°</b>
Max. supply voltage AC $U_B$	24 V AC	230 V AC
Max. supply voltage DC $U_B$	24 V DC	230 V DC
Cable	Molded	Molded
Current rating	4.0 A	4.0 A
Suppressor	Suppressor diode	No
Number of conductors × conductor cross-section	3×0.5mm <sup>2</sup>	3×0.5mm <sup>2</sup>
Degree of protection as per IEC 60529	IP 67	IP 67
Ambient temperature $T_a$	PUR -25...+90 °C/-25...+80 °C	-25...+90 °C/-25...+80 °C
Static/moving	PVC -25...+105 °C/-25...+105 °C	-25...+105 °C/-25...+105 °C
LED	Yellow	without

Cable material	Color	Length	Ordering code	
			Part number	
PUR	Black	2 m	<b>BCC04W0</b>	<b>BCC04W6</b>
			BCC VA04-0000-10-053-PX0350-020	BCC VA04-0000-10-054-PX0350-020
PUR	Black	5 m	<b>BCC04W1</b>	<b>BCC04W7</b>
			BCC VA04-0000-10-053-PX0350-050	BCC VA04-0000-10-054-PX0350-050
PUR	Black	10 m	<b>BCC04W2</b>	<b>BCC04W8</b>
			BCC VA04-0000-10-053-PX0350-100	BCC VA04-0000-10-054-PX0350-100
PVC	Gray	2 m	<b>BCC04W3</b>	<b>BCC04W9</b>
			BCC VA04-0000-10-053-VX8350-020	BCC VA04-0000-10-054-VX8350-020
PVC	Gray	5 m	<b>BCC04W4</b>	<b>BCC04WA</b>
			BCC VA04-0000-10-053-VX8350-050	BCC VA04-0000-10-054-VX8350-050
PVC	Gray	10 m	<b>BCC04W5</b>	<b>BCC04WC</b>
			BCC VA04-0000-10-053-VX8350-100	BCC VA04-0000-10-054-VX8350-100

Other cable materials, colors, and lengths on request.

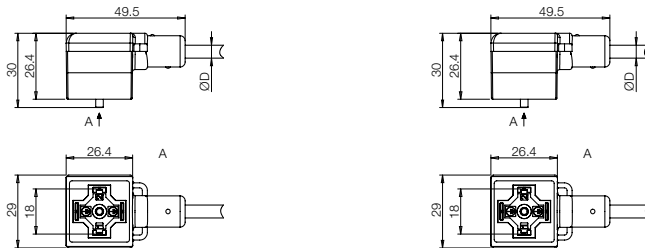

# Valve Connectors

## Style A, DIN, 18 mm, 4-pin M12 male, straight



Connector diagram and wiring		
Cable outlet	<b>0°/180°</b>	
Max. supply voltage AC $U_B$	24 V AC	
Max. supply voltage DC $U_B$	24 V DC	
Cable	Molded/molded	
Current rating	4.0 A	
Suppressor	Suppressor diode	
Number of conductors × conductor cross-section	3×0.5mm <sup>2</sup>	
Degree of protection as per IEC 60529	IP 67/IP 68	
Ambient temperature $T_a$	Static Tensioned	-25...+90 °C -25...+80 °C
LED	Yellow	

Cable material	Color	Length	Ordering code
			Part number
PUR	Black	0.3 m	<b>BCC04WF</b> BCC VA04-M413-3E-664-PX0350-003
PUR	Black	0.6 m	<b>BCC04WH</b> BCC VA04-M413-3E-664-PX0350-006
PUR	Black	1 m	<b>BCC0502</b> BCC VA04-M413-3E-664-PX0350-010
PUR	Black	1.5 m	<b>BCC04WJ</b> BCC VA04-M413-3E-664-PX0350-015
PUR	Black	2 m	<b>BCC04WK</b> BCC VA04-M413-3E-664-PX0350-020
PUR	Black	3 m	<b>BCC04WL</b> BCC VA04-M413-3E-664-PX0350-030
PUR	Black	5 m	<b>BCC04WM</b> BCC VA04-M413-3E-664-PX0350-050

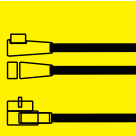

Connectors  
**Style A**  
 DIN  
 Style B  
 DIN  
 Style B  
 Industry  
 Style C  
 DIN  
 Style C  
 Industry  
 Connectors  
 for pressure  
 switches

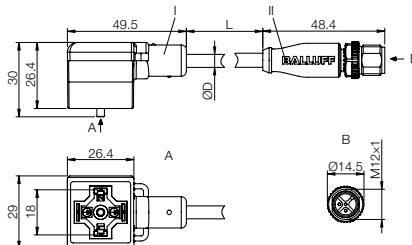

Other cable materials, colors, and lengths on request.



# Valve Connectors

## Style B, DIN, 10 mm, 3-pin



Connector diagram and wiring	 PIN 1: black PIN 2: blue PIN PE: green/yellow	 PIN 1: black PIN 2: blue PIN PE: green/yellow
Cable outlet	<b>0°</b>	<b>180°</b>
Max. supply voltage AC $U_B$	24 V AC	24 V AC
Max. supply voltage DC $U_B$	24 V DC	24 V DC
Cable	Molded	Molded
Current rating	4.0 A	4.0 A
Suppressor	Suppressor diode	Suppressor diode
Number of conductors x conductor cross-section	3x0.5mm <sup>2</sup>	3x0.5mm <sup>2</sup>
Degree of protection as per IEC 60529	IP 67	IP 67
Ambient temperature $T_a$	PUR -25...+90 °C/-25...+80 °C	-25...+90 °C/-25...+80 °C
Static/moving	PVC -25...+105 °C/-25...+105 °C	-25...+105 °C/-25...+105 °C
LED	Yellow	Yellow

Cable material	Color	Length	Ordering code	
			Part number	
PUR	Black	2 m	<b>BCC03YC</b>	<b>BCC03YH</b>
			BCC VB03-0000-10-055-PX0350-020	BCC VB23-0000-10-055-PX0350-020
PUR	Black	5 m	<b>BCC03YE</b>	<b>BCC03YJ</b>
			BCC VB03-0000-10-055-PX0350-050	BCC VB23-0000-10-055-PX0350-050
PUR	Black	10 m	<b>BCC03YF</b>	<b>BCC03YK</b>
			BCC VB03-0000-10-055-PX0350-100	BCC VB23-0000-10-055-PX0350-100
PVC	Gray	2 m	<b>BCC03ZZ</b>	<b>BCC0402</b>
			BCC VB03-0000-10-055-VX8350-020	BCC VB23-0000-10-055-VX8350-020
PVC	Gray	5 m	<b>BCC0400</b>	<b>BCC0403</b>
			BCC VB03-0000-10-055-VX8350-050	BCC VB23-0000-10-055-VX8350-050
PVC	Gray	10 m	<b>BCC0401</b>	<b>BCC0404</b>
			BCC VB03-0000-10-055-VX8350-100	BCC VB23-0000-10-055-VX8350-100

Other cable materials, colors, and lengths on request.

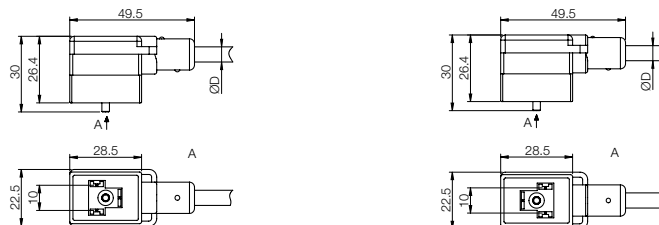



# Valve Connectors

## Style B, DIN, 10 mm, 3-pin M12 male, straight



Connector diagram and wiring		
Cable outlet	<b>0°</b>	<b>180°</b>
Max. supply voltage AC $U_B$	24 V AC	24 V AC
Max. supply voltage DC $U_B$	24 V DC	24 V DC
Cable	Molded/molded	Molded/molded
Current rating	4.0 A	4.0 A
Suppressor	Suppressor diode	Suppressor diode
Number of conductors × conductor cross-section	3×0.5mm <sup>2</sup>	3×0.5mm <sup>2</sup>
Degree of protection as per IEC 60529	IP 67/IP 68	IP 67/IP 68
Ambient temperature $T_a$	Static -25...+90 °C Tensioned -25...+80 °C	-25...+90 °C -25...+80 °C
LED	Yellow	Yellow

Cable material	Color	Length	Ordering code	
			Part number	
PUR	Black	0.3 m	<b>BCC064E</b>	<b>BCC064N</b>
			BCC VB03-M413-3E-666-PX0350-003	BCC VB23-M413-3E-666-PX0350-003
PUR	Black	0.6 m	<b>BCC064F</b>	<b>BCC064P</b>
			BCC VB03-M413-3E-666-PX0350-006	BCC VB23-M413-3E-666-PX0350-006
PUR	Black	1 m	<b>BCC064H</b>	<b>BCC064R</b>
			BCC VB03-M413-3E-666-PX0350-010	BCC VB23-M413-3E-666-PX0350-010
PUR	Black	1.5 m	<b>BCC064J</b>	<b>BCC064T</b>
			BCC VB03-M413-3E-666-PX0350-015	BCC VB23-M413-3E-666-PX0350-015
PUR	Black	2 m	<b>BCC064K</b>	<b>BCC064U</b>
			BCC VB03-M413-3E-666-PX0350-020	BCC VB23-M413-3E-666-PX0350-020
PUR	Black	3 m	<b>BCC064L</b>	<b>BCC064W</b>
			BCC VB03-M413-3E-666-PX0350-030	BCC VB23-M413-3E-666-PX0350-030
PUR	Black	5 m	<b>BCC064M</b>	<b>BCC064Y</b>
			BCC VB03-M413-3E-666-PX0350-050	BCC VB23-M413-3E-666-PX0350-050

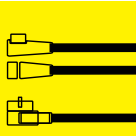

Connectors  
Style A  
DIN  
**Style B  
DIN**  
Style B  
Industry  
Style C  
DIN  
Style C  
Industry  
Connectors for pressure switches

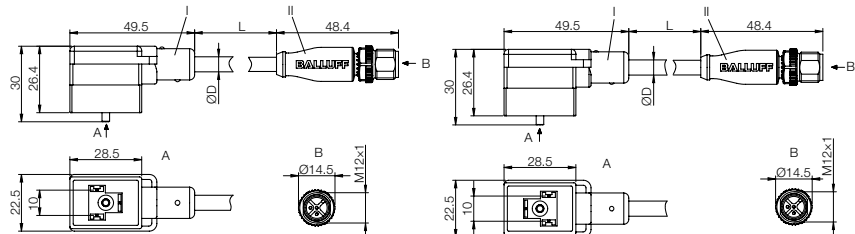

Other cable materials, colors, and lengths on request.



# Valve Connectors

## Style B, Industry, 11 mm, 3-pin



Connector diagram and wiring	 PIN 1: black PIN 2: blue PIN PE: green/yellow	 PIN 1: black PIN 2: blue PIN PE: green/yellow
Cable outlet	<b>0°</b>	<b>180°</b>
Max. supply voltage AC $U_B$	24 V AC	24 V AC
Max. supply voltage DC $U_B$	24 V DC	24 V DC
Cable	Molded	Molded
Current rating	4.0 A	4.0 A
Suppressor	Suppressor diode	Suppressor diode
Number of conductors × conductor cross-section	3×0.5mm <sup>2</sup>	3×0.5mm <sup>2</sup>
Degree of protection as per IEC 60529	IP 67	IP 67
Ambient temperature $T_a$	PUR -25...+90 °C/-25...+80 °C	-25...+90 °C/-25...+80 °C
Static/moving	PVC -25...+105 °C/-25...+105 °C	-25...+105 °C/-25...+105 °C
LED	Yellow	Yellow

Cable material	Color	Length	Ordering code	
			Part number	
PUR	Black	2 m	<b>BCC03YL</b>	<b>BCC03YP</b>
			BCC VB43-0000-10-055-PX0350-020	BCC VB63-0000-10-055-PX0350-020
PUR	Black	5 m	<b>BCC03YM</b>	<b>BCC03YR</b>
			BCC VB43-0000-10-055-PX0350-050	BCC VB63-0000-10-055-PX0350-050
PUR	Black	10 m	<b>BCC03YN</b>	<b>BCC03YT</b>
			BCC VB43-0000-10-055-PX0350-100	BCC VB63-0000-10-055-PX0350-100
PVC	Gray	2 m	<b>BCC0405</b>	<b>BCC0408</b>
			BCC VB43-0000-10-055-VX8350-020	BCC VB63-0000-10-055-VX8350-020
PVC	Gray	5 m	<b>BCC0406</b>	<b>BCC0409</b>
			BCC VB43-0000-10-055-VX8350-050	BCC VB63-0000-10-055-VX8350-050
PVC	Gray	10 m	<b>BCC0407</b>	<b>BCC040A</b>
			BCC VB43-0000-10-055-VX8350-100	BCC VB63-0000-10-055-VX8350-100

Other cable materials, colors, and lengths on request.

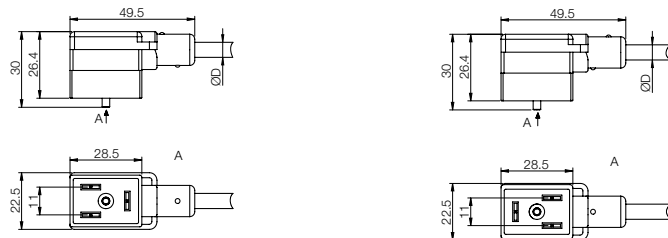

# Valve Connectors

## Style B, Industry, 11 mm, 3-pin M12 male, straight



Connector diagram and wiring		
Cable outlet	<b>0°</b>	<b>180°</b>
Max. supply voltage AC $U_B$	24 V AC	24 V AC
Max. supply voltage DC $U_B$	24 V DC	24 V DC
Cable	Molded/molded	Molded/molded
Current rating	4.0 A	4.0 A
Suppressor	Suppressor diode	Suppressor diode
Number of conductors × conductor cross-section	3×0.5mm <sup>2</sup>	3×0.5mm <sup>2</sup>
Degree of protection as per IEC 60529	IP 67/IP 68	IP 67/IP 68
Ambient temperature $T_a$	Static -25...+90 °C Tensioned -25...+80 °C	Static -25...+90 °C Tensioned -25...+80 °C
LED	Yellow	Yellow

Cable material	Color	Length	Ordering code	
			Part number	
PUR	Black	0.3 m	<b>BCC064Z</b>	<b>BCC0656</b>
			BCC VB43-M413-3E-666-PX0350-003	BCC VB63-M413-3E-666-PX0350-003
PUR	Black	0.6 m	<b>BCC0650</b>	<b>BCC0657</b>
			BCC VB43-M413-3E-666-PX0350-006	BCC VB63-M413-3E-666-PX0350-006
PUR	Black	1 m	<b>BCC0651</b>	<b>BCC0658</b>
			BCC VB43-M413-3E-666-PX0350-010	BCC VB63-M413-3E-666-PX0350-010
PUR	Black	1.5 m	<b>BCC0652</b>	<b>BCC0659</b>
			BCC VB43-M413-3E-666-PX0350-015	BCC VB63-M413-3E-666-PX0350-015
PUR	Black	2 m	<b>BCC0653</b>	<b>BCC065A</b>
			BCC VB43-M413-3E-666-PX0350-020	BCC VB63-M413-3E-666-PX0350-020
PUR	Black	3 m	<b>BCC0654</b>	<b>BCC065C</b>
			BCC VB43-M413-3E-666-PX0350-030	BCC VB63-M413-3E-666-PX0350-030
PUR	Black	5 m	<b>BCC0655</b>	<b>BCC065E</b>
			BCC VB43-M413-3E-666-PX0350-050	BCC VB63-M413-3E-666-PX0350-050

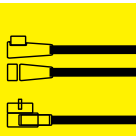

Connectors  
Style A  
DIN  
Style B  
DIN  
**Style B  
Industry**  
Style C  
DIN  
Style C  
Industry  
Connectors for pressure switches

Other cable materials, colors, and lengths on request.

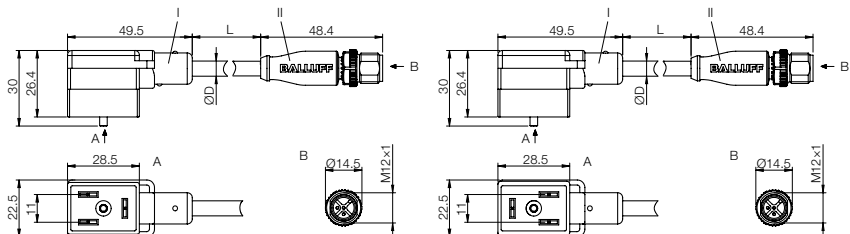

# Valve Connectors

## Style C, DIN, 8 mm, 4-pin

## Style C, DIN, 8 mm, 4-pin, male M12, straight



Connector diagram and wiring

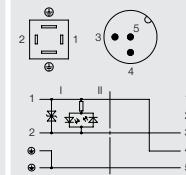
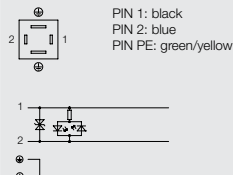

Cable outlet		<b>0°/180°</b>	<b>0°/180°</b>
Max. supply voltage AC $U_B$		24 V AC	24 V AC
Max. supply voltage DC $U_B$		24 V DC	24 V DC
Cable		Molded	Molded/molded
Current rating		4.0 A	4.0 A
Suppressor		Suppressor diode	Suppressor diode
Number of conductors × conductor cross-section		3×0.5mm <sup>2</sup>	3×0.5mm <sup>2</sup>
Degree of protection as per IEC 60529		IP 67	IP 67/IP 68
Ambient temperature $T_a$	PUR	-25...+90 °C/-25...+80 °C	-25...+90 °C/-25...+80 °C
Static/moving	PVC	-25...+105 °C/-25...+105 °C	-25...+105 °C/-25...+105 °C
LED		Yellow	Yellow

Cable material	Color	Length	Ordering code	
			Part number	
PUR	Black	0.3 m		<b>BCC04NC</b> BCC VC04-M413-3E-664-PX0350-003
PUR	Black	0.6 m		<b>BCC04NE</b> BCC VC04-M413-3E-664-PX0350-006
PUR	Black	1 m		<b>BCC04NF</b> BCC VC04-M413-3E-664-PX0350-010
PUR	Black	1.5 m		<b>BCC04NH</b> BCC VC04-M413-3E-664-PX0350-015
PUR	Black	2 m	<b>BCC04MZ</b> BCC VC04-0000-10-053-PX0350-020	<b>BCC04NJ</b> BCC VC04-M413-3E-664-PX0350-020
PUR	Black	3 m		<b>BCC04NK</b> BCC VC04-M413-3E-664-PX0350-030
PUR	Black	5 m	<b>BCC04N0</b> BCC VC04-0000-10-053-PX0350-050	<b>BCC04NL</b> BCC VC04-M413-3E-664-PX0350-050
PUR	Black	10 m	<b>BCC04N1</b> BCC VC04-0000-10-053-PX0350-100	
PVC	Gray	2 m	<b>BCC04N2</b> BCC VC04-0000-10-053-VX8350-020	
PVC	Gray	5 m	<b>BCC04N3</b> BCC VC04-0000-10-053-VX8350-050	
PVC	Gray	10 m	<b>BCC04N4</b> BCC VC04-0000-10-053-VX8350-100	

Other cable materials, colors, and lengths on request.

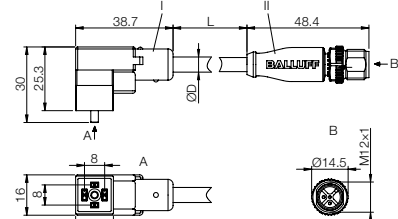
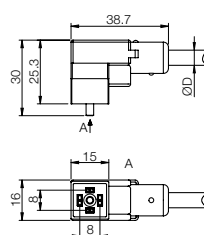

# Valve Connectors

## Style C, Industry, 9.4 mm, 4-pin

## Style C, Industry, 9.4 mm, 4-pin, male M12, straight



Connector diagram and wiring	<p>PIN 1: black PIN 2: blue PIN PE: green/yellow</p>	
Cable outlet	<b>0°/180°</b>	<b>0°/180°</b>
Max. supply voltage AC $U_B$	24 V AC	24 V AC
Max. supply voltage DC $U_B$	24 V DC	24 V DC
Cable	Molded	Molded/molded
Current rating	4.0 A	4.0 A
Suppressor	Suppressor diode	Suppressor diode
Number of conductors × conductor cross-section	3×0.5mm <sup>2</sup>	3×0.5mm <sup>2</sup>
Degree of protection as per IEC 60529	IP 67	IP 67/IP 68
Ambient temperature $T_a$	PUR -25...+90 °C/-25...+80 °C	-25...+90 °C/-25...+80 °C
Static/moving	PVC -25...+105 °C/-25...+105 °C	-25...+105 °C/-25...+105 °C
LED	Yellow	Yellow

Cable material	Color	Length	Ordering code	
			Part number	
PUR	Black	0.3 m		<b>BCC04RY</b> BCC VC44-M413-3E-664-PX0350-003
PUR	Black	0.6 m		<b>BCC04RZ</b> BCC VC44-M413-3E-664-PX0350-006
PUR	Black	1 m		<b>BCC04T0</b> BCC VC44-M413-3E-664-PX0350-010
PUR	Black	1.5 m		<b>BCC04T1</b> BCC VC44-M413-3E-664-PX0350-015
PUR	Black	2 m	<b>BCC04RF</b> BCC VC44-0000-10-053-PX0350-020	<b>BCC04T2</b> BCC VC44-M413-3E-664-PX0350-020
PUR	Black	3 m		<b>BCC04T3</b> BCC VC44-M413-3E-664-PX0350-030
PUR	Black	5 m	<b>BCC04RH</b> BCC VC44-0000-10-053-PX0350-050	<b>BCC04T4</b> BCC VC44-M413-3E-664-PX0350-050
PUR	Black	10 m	<b>BCC04RJ</b> BCC VC44-0000-10-053-PX0350-100	
PVC	Gray	2 m	<b>BCC04RK</b> BCC VC44-0000-10-053-VX8350-020	
PVC	Gray	5 m	<b>BCC04RL</b> BCC VC44-0000-10-053-VX8350-050	
PVC	Gray	10 m	<b>BCC04RM</b> BCC VC44-0000-10-053-VX8350-100	

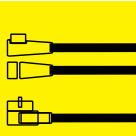

Connectors  
Style A  
DIN  
Style B  
DIN  
Style B  
Industry  
**Style C  
DIN**  
**Style C  
Industry**  
Connectors for pressure switches

Other cable materials, colors, and lengths on request.

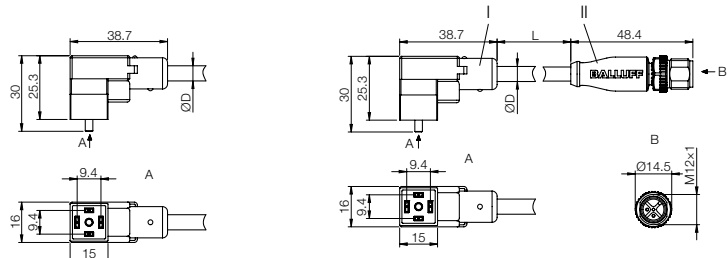

# Valve Connectors

## Connectors for pressure switches, 4-pin



Connector diagram and wiring		PIN 1: brown PIN 2: white PIN 3: black No PIN: blue PE PIN: green/yellow  <sup>1)</sup> Yellow LED = Function <sup>2)</sup> Green LED = Function		PIN 1: brown PIN 2: white PIN 3: black No PIN: blue PE PIN: green/yellow  <sup>1)</sup> Yellow LED = Function <sup>2)</sup> Green LED = Function
Cable outlet	<b>0°</b>		<b>180°</b>	
Max. supply voltage AC U <sub>B</sub>	24 V AC		24 V AC	
Max. supply voltage DC U <sub>B</sub>	24 V DC		24 V DC	
Cable	Molded		Molded	
Current rating	4.0 A		4.0 A	
Suppressor	No		No	
Number of conductors × conductor cross-section	5×0.5 mm <sup>2</sup>		5×0.5 mm <sup>2</sup>	
Degree of protection as per IEC 60529	IP 67		IP 67	
Ambient temperature T <sub>a</sub> Static	-30...+90 °C		-30...+90 °C	
Ambient temperature T <sub>a</sub> Tensioned	-5...+80 °C		-5...+80 °C	
LED	Yellow/Green		Yellow/Green	

Cable material	Color	Length	Ordering code
			Part number
PUR	Black	2 m	<b>BCC071A</b> BCC PA04-0000-10-070-PX0550-020
PUR	Black	5 m	<b>BCC071C</b> BCC PA04-0000-10-070-PX0550-050
PUR	Black	10 m	<b>BCC071E</b> BCC PA04-0000-10-070-PX0550-100
			<b>BCC071F</b> BCC PA24-0000-10-070-PX0550-020
			<b>BCC071H</b> BCC PA24-0000-10-070-PX0550-050
			<b>BCC071J</b> BCC PA24-0000-10-070-PX0550-100

Other cable materials, colors, and lengths on request.

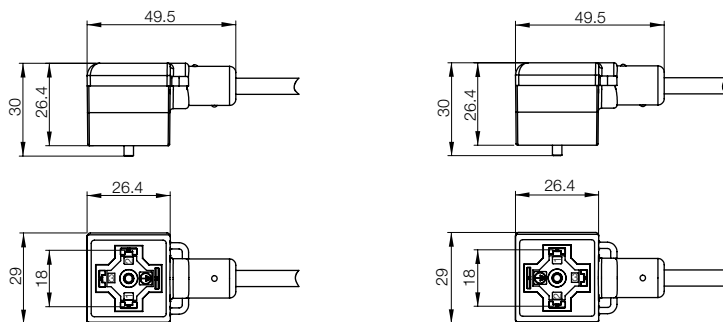

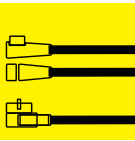

Connectors

Style A  
DIN

Style B  
DIN

Style B  
Industry

Style C  
DIN

Style C  
Industry

**Connectors  
for pressure  
switches**

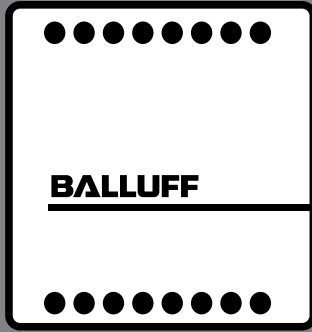

# Power Supplies

## Power Supplies

Industrial automation is becoming ever more demanding and the complexity of its tasks is constantly increasing. Efficient operation of equipment and machines demands reliable power sources more than ever. Balluff power supplies are the powerful solution for fault-free system operation.

Take advantage of the special benefits of Balluff power supplies

- Full product line – choose just what you need
- Short-circuit and overload protection in industrial environments
- High availability of all devices
- Unlimited, precise power for increased demands
- Long service life for reliable operation
- Worldwide approvals for use anywhere





# Power Supplies

## Contents

Intelligent power supplies	364
Single-phase power supplies	370
Three-phase power supplies	378
Technical data	381

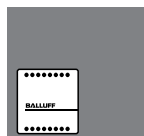

# Power Supplies

## Reliable performance for high requirements

Every industrial automation system needs a reliable, clean, and controlled source of power without spikes. Only then can these systems deliver the expected performance.

Balluff power supplies ensure reliable power even under demanding conditions and deliver reliable, high-quality performance.

### ■ Ultra-reliable power supplies

for protecting sensitive control electronics

### ■ Protection against unforeseen events

Integrated overload and overvoltage protection

### ■ Wide selection of models

Individual devices or individually combinations of different models available

### ■ Clean, precise power supply for particularly demanding systems

Load regulation  $\pm 1\%$  for all models, ripple and noise under 50 mV for most models

### ■ Long service life for less system downtime

MTBF (Mean Time Between Failure) up to 800,000 hours/ 91 years



### Parallel/single mode

If more power is required, multiple units can be combined in parallel (most models)

### Adjustable output

The output voltage can be adjusted to compensate for losses from cabling and distributed components



### Status indicator

LED for DC ON and DC LO indicator (most models)

### Terminals with contact protection

No additional protection necessary



### Ready output

Notifies the control system that the power supply is ready (included with most models)

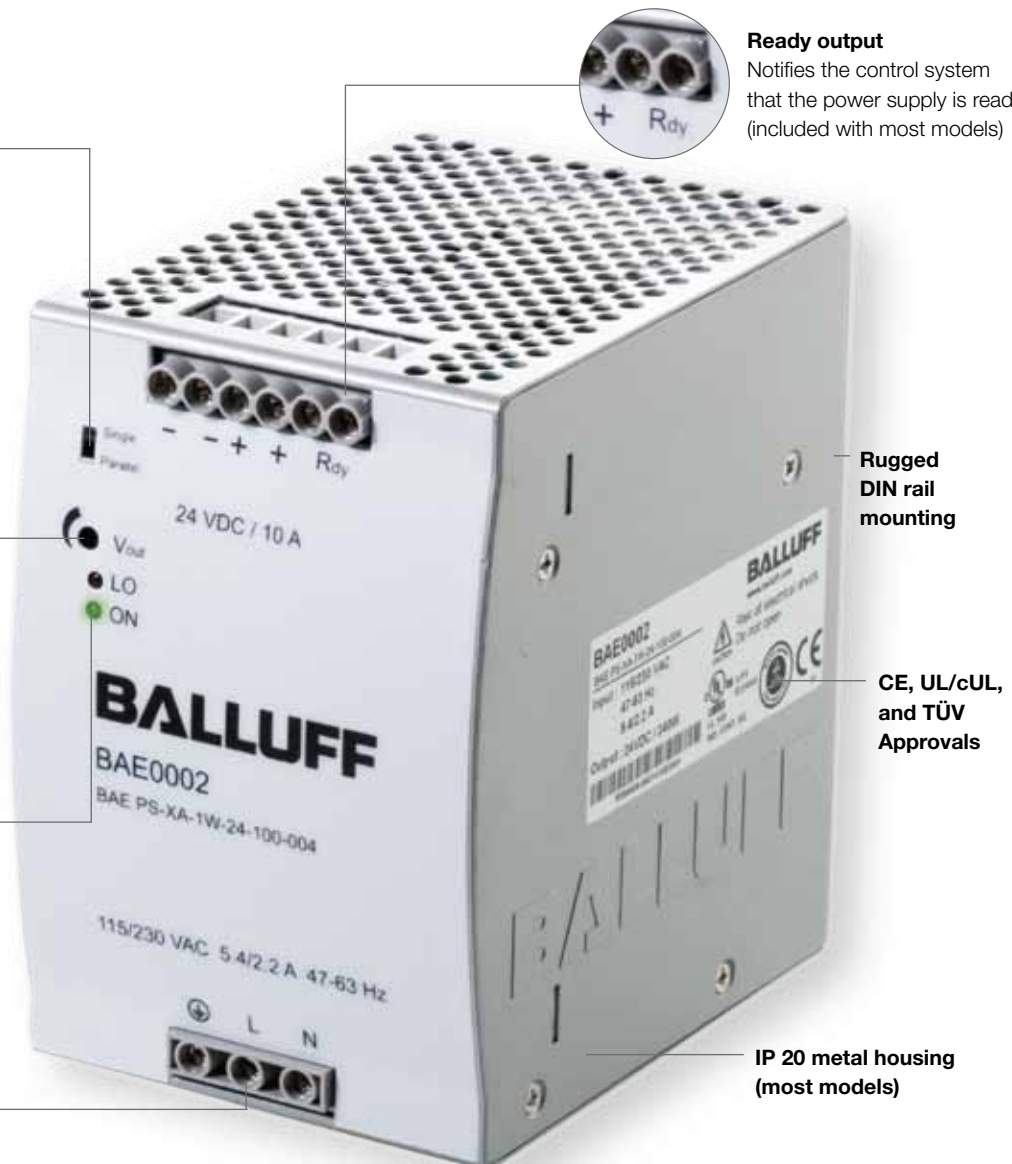

Rugged DIN rail mounting

CE, UL/cUL, and TÜV Approvals

IP 20 metal housing (most models)

# Power Supplies

## Standard units

Version	Output power	Features		Product information		Page	
		Input voltage	Housing material	Ordering code	Part number		
Standard IP 20	12 V	0.75 mA/18 W	Single-phase <sup>1</sup>	Plastic	BAE0036	BAE-PS-XA-1W-12-015-001	370
		1.25 A/30 W	Single-phase <sup>1</sup>	Plastic	BAE0039	BAE-PS-XA-1W-12-025-002	371
		1.5 A/18 W	Single-phase <sup>1</sup>	Metal	BAE003E	BAE-PS-XA-1W-12-050-002	373
	24 V	2.5 A/30 W	Single-phase <sup>2</sup>	Metal	BAE003H	BAE-PS-XA-1W-12-100-003	375
		2.5 A/60 W	Single-phase <sup>1</sup>	Plastic	BAE0001	BAE-PS-XA-1W-24-007-001	370
		2.5 A/120 W	Single-phase <sup>1</sup>	Plastic	BAE0004	BAE-PS-XA-1W-24-012-002	371
		3.8 A/91.20 W	Single-phase <sup>1</sup>	Plastic	BAE0005	BAE-PS-XA-1W-24-025-002	372
		5 A/60 W	Single-phase <sup>2</sup>	Metal	BAE003J	BAE-PS-XA-1W-24-038-003	374
		5 A/120 W	Single-phase <sup>2</sup>	Metal	BAE0006	BAE-PS-XA-1W-24-050-003	375
		5 A/240 W	Single-phase <sup>2</sup>	Metal	BAE0002	BAE-PS-XA-1W-24-100-004	376
		8 A/200 W	Single-phase <sup>2</sup>	Metal	BAE0003	BAE-PS-XA-1W-24-200-005	377
		10 A/120 W	3-phase <sup>3</sup>	Metal	BAE0007	BAE-PS-XA-3Y-24-050-009	378
		10 A/240 W	3-phase <sup>3</sup>	Metal	BAE0008	BAE-PS-XA-3Y-24-100-006	379
		10 A/480 W	3-phase <sup>3</sup>	Metal	BAE0009	BAE-PS-XA-3Y-24-200-007	379
48 V	20 A/480 W	3-phase <sup>3</sup>	Metal	BAE003R	BAE-PS-XA-3Y-24-400-010	380	
	40 A/960 W	Single-phase <sup>2</sup>	Plastic	BAE003K	BAE-PS-XA-1W-48-025-003	374	
Intelligent devices IP 20	24 V	Single-phase <sup>2</sup>	Metal	BAE003L	BAE-PS-XA-1W-48-050-004	376	
		Single-phase <sup>2</sup>	Metal	BAE003M	BAE-PS-XA-1W-48-100-005	377	
Intelligent devices IP 67	24 V	Single-phase <sup>1</sup>	Metal	BAE00EK	BAE-PS-XA-1W-24-050-013	365	
		Single-phase <sup>1</sup>	Metal	BAE00EU	BAE-PS-XA-1W-24-100-014	365	
		Single-phase <sup>1</sup>	Metal	BAE00EN	BAE-PS-XA-1W-24-038-601	366	
		Single-phase <sup>1</sup>	Metal	BAE00EP	BAE-PS-XA-1W-24-038-602	366	
		Single-phase <sup>1</sup>	Metal	BAE00ER	BAE-PS-XA-1W-24-038-603	367	
		Single-phase <sup>1</sup>	Metal	BAE00FW	BAE-PS-XA-1W-24-038-607	367	
		Single-phase <sup>1</sup>	Metal	BAE00ET	BAE-PS-XA-1W-24-080-604	367	
Single-phase <sup>1</sup>	Metal	BAE00FL	BAE-PS-XA-1W-24-080-605	368			
Single-phase <sup>1</sup>	Metal	BAE00FY	BAE-PS-XA-1W-24-080-606	368			

<sup>1</sup> = 100...240 V AC

<sup>2</sup> = 115/230 V AC (Auto-Select)

<sup>3</sup> = 340...575 V AC

### Power for controllers and networks

Specially developed for controller units, Balluff power supplies can be perfectly integrated into control packages.

The PS series of ultra-reliable power supply units is available in a wide range of 12, 24, and 48 V DC models with single or 3-phase input. With a bandwidth of 18 to 960 W, they truly leave nothing to be desired. Several power supplies can be connected for even more power (parallel mode).

If you need other voltage levels, simply contact us.



## Reliable performance for the high requirements in industrial automation

### Intelligent power supply units – For outstanding system availability

If you want to operate your systems and machines with maximum efficiency, the power supply you use must be reliable. Intelligent power supply units from Balluff guarantee a high degree of reliability. They provide a complete picture of their environment wherever they are installed, allowing you to monitor the environment continuously.

#### LEDs for easy monitoring

- Load level
- Stress level
- Lifetime

LEDs indicate the load level and stress level so the operator knows immediately when the unit is operating at maximum performance. LEDs also show the service life of the devices, simplifying maintenance and operation. The user can also see when a device has to be replaced. This is how Balluff power supply units contribute to increased system availability.

### The benefits to you

- Continuous monitoring of machines and systems
- Reliable power supply units guarantee efficient operation
- Optimized use of devices and a longer service life
- Maintenance planning
- Devices only replaced when necessary

### Versions

Intelligent power supply units from Balluff are available in two versions

#### IP 20 (with screw terminal)

- With wide input voltage range from 90...264 V AC
- Designed for versatile use in industrial automation
- Also satisfies all wind turbine requirements

#### IP 67 (with connector)

- Can be used directly in harsh environments
- Fully potted housing
- High shock and vibration ratings

# Power Supplies

## Reliable performance for the high requirements of industrial automation

### Load level



#### Load level

■ Reversible in short term

Load level indicates the current load on the device. The display indicates the load without delay.

### Heartbeat



#### Stress level

■ Reversible in medium term

Stress level indicates the physical and thermal loads. Changing the load has an effect on device wear.

### Wear indicator



#### Lifetime

■ Irreversible in long term

Lifetime indicates the remaining service life of the device based on the sum of all loads.

- All indicators are multi-colored –
- green, yellow, or red – and show the
- status of the device.



Power Supplies  
Intelligent power supply units  
Single-phase power supplies  
Three-phase power supplies  
Technical data

# Power Supplies

## Intelligent devices for the demanding requirements of industrial automation

### Intelligent power supply units

The installation of local power supply units without switch cabinets with the IP 67 degree of protection is becoming more popular in industrial automation. Although local power supply units are already available, they are generally difficult to access once installed. To further complicate matters, it is practically impossible to monitor the operating state. As a result, operators rely on preventive maintenance concepts to guarantee maximum possible availability. This procedure is reliable, but also expensive, because devices are frequently replaced during the maintenance cycle well before the end of their service life, as there is no alternative system available.

For the first time, intelligent, energy-saving power supply units from Balluff remedy this situation. They have visual displays that indicate their status – with load level, stress level and lifetime. This enables operation under continuously high load and eliminates the need for typical reserves of 30 to 50%.

Ideal areas of application for these intelligent power supply units include local installations in the automobile industry, machine construction, wind turbines, etc.

### IP 67



### IP 20



### General key information about the IP 20 and IP 67 power supply units

- High efficiency of up to 92%
- Minimal heat loss and generation
- Increasing efficiency of the systems
- 3-stage status indication
- Power boost (150% for 4 sec.)
- Extremely compact
- More efficient utilization of the power supply units
- Planned reserves are not wasted
- Prevention of failures since there is no continuous overload
- Scheduled maintenance and repairs no longer necessary
- Higher productivity
- PSU replaced only at the end of its service life
- Service life of 15 years (at 80% load and 40 °C)
- Enclosed housing guarantees high degree of resistance to vibration and shock loads
- With IP 20, also with floating alarm contacts

# Power Supplies

## Intelligent devices

### 5 A, 10 A



Output current	5 A	10 A
Output power	120 W	240 W
Output voltage	24 V DC (SELV)	24 V DC (SELV)
Input voltage	100...240 V AC	100...240 V AC
	Single phase	single-phase
<b>Ordering code</b>	<b>BAE00EK</b>	<b>BAE00EU</b>
Part number	BAE PS-XA-1W-24-050-013	BAE PS-XA-1W-24-100-014
Input voltage range	90...264 V AC/135...340 V DC	90...264 V AC/135...340 V DC
Inrush current	1.14 at 230 VAC/2.1 A at 110 V AC	2.11 at 230 V AC/4.4 A at 110 V AC
Frequency range	48...62 Hz	48...62 Hz
Input fuse	6.3 A/250 V AC internal	6.3 A/250 V AC internal
Voltage adjustment range	22...28 V DC	22...28 V DC
Temperature coefficient max.	±0.03%/°C	0.03%/°C
Hold-up time	> 150 ms at 230 V AC/> 25 ms at 115 V AC	> 120 ms at 230 V AC/> 15 ms at 115 V AC
Status indicator	Stress level, lifetime, load level	Stress level, lifetime, load level
Power boost	150% for 4 s	150% for 4 s
Efficiency	High efficiency, typically > 89%	High efficiency, typically > 91%
Response	Forward characteristic	Forward characteristic
Ambient temperature range	-25...+70 °C	-25...+70 °C
Storage temperature	-40...+80 °C	-40...+80 °C
Fastener	DIN rail mounting	DIN rail mounting
Parallel mode	Yes (with external diodes)	Yes (with external diodes)
Degree of protection as per IEC 60529	IP 20	IP 20
Derating	-2.5%/ °C above +60 °C	-2.5%/ °C above +60 °C
Cooling	Free convection	Free convection
Housing material	Metal, semi-potted	Metal, semi-potted
Service life (at 80% load and 40 °C)	15 years	15 years
Warranty	2 years	2 years
Weight	0.80 kg	1.15 kg
Approvals	CE	CE
Wiring diagram	<p>PE N L</p> <p>+</p> <p>-</p> <p>DC Alarm</p> <p>Lifetime</p> <p>Common</p>	<p>PE N L</p> <p>+</p> <p>-</p> <p>DC Alarm</p> <p>Lifetime</p> <p>Common</p>



Power Supplies  
Intelligent power supply units  
Single-phase power supplies  
Three-phase power supplies  
Technical data

\*SELV = Safety Extra Low Voltage

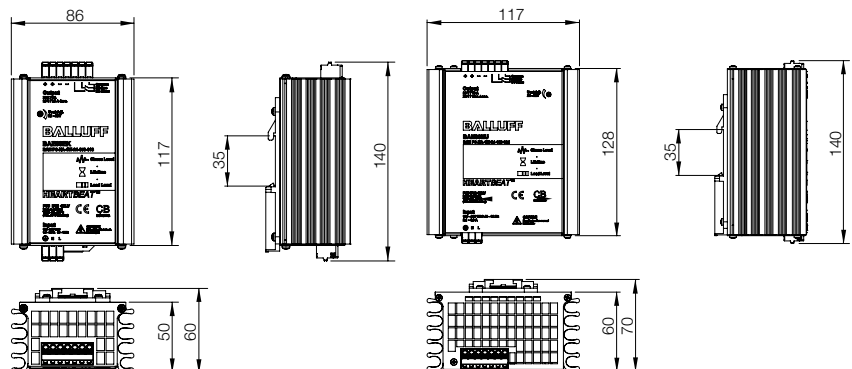



# Power Supplies

## Intelligent devices

### 3.8 A



Output current	3.8 A	3.8 A
Output power	91.2 W	91.2 W
Output voltage	24 V DC (SELV)	24 V DC (PELV)
Input voltage	100...240 V AC Single phase	100...240 V AC single-phase
<b>Ordering code</b>	<b>BAE00EN</b>	<b>BAE00EP</b>
Part number	BAE PS-XA-1W-24-038-601	BAE PS-XA-1W-24-038-602
Input voltage range	90...264 V AC/ 135...340 V DC	90...264 V AC/ 135...340 V DC
Inrush current	< 30 A	< 30 A
Frequency range	48...62 Hz	48...62 Hz
Input fuse	6.3 A/250 V AC internal	6.3 A/250 V AC internal
Voltage adjustment range	24 V DC fixed adjustment	24 V DC fixed adjustment
Temperature coefficient max.	±0.03%/°C	±0.03%/°C
Hold-up time	> 200 ms at 230 V AC/> 40 ms at 115 V AC	> 200 ms at 230 V AC/> 40 ms at 115 V AC
Status indicator	Stress level, lifetime, load level	Stress level, lifetime, load level
Power boost	150% for 4 s	150% for 4 s
Efficiency	High efficiency, typically > 88%	High efficiency, typically > 88%
Input	3-pin (male)	3-pin (male)
Output	4-pin (female)	4-pin (female) e.g. for DeviceNet, Ethernet/IP modules
Response	Forward characteristic	Forward characteristic
Ambient temperature range	-25...+70 °C	-25...+70 °C
Storage temperature	-40...+80 °C	-40...+80 °C
Fastener	Panel, wall, and field mounting	Panel, wall, and field mounting
Degree of protection as per IEC 60529	IP 67	IP 67
Derating	-2.5%/°C above +60 °C	-2.5%/°C above +60 °C
Cooling	Free convection	Free convection
Housing material	Metal, fully potted	Metal, fully potted
Service life (at 80% load and 40 °C)	15 years	15 years
Warranty	2 years	2 years
Weight	1 kg	1 kg
Approvals	CE	CE
Wiring diagram		

\*SELV = Safety Extra Low Voltage

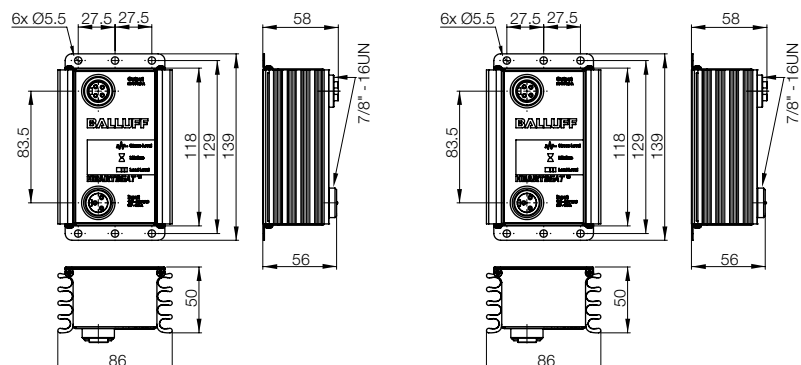



# Power Supplies

## Intelligent devices

### 3.8 A, 8 A



3.8 A	3.8 A	8 A
91.2 W	91.2 W	192 W
24 V DC (SELV)	24 V DC (SELV)	24 V DC (SELV)
100...240 V AC	100...240 V AC	100...240 V AC
single-phase	single-phase	single-phase
<b>BAE00ER</b>	<b>BAE00FW</b>	<b>BAE00ET</b>
BAE PS-XA-1W-24-038-603	BAE PS-XA-1W-24-038-607	BAE PS-XA-1W-24-080-604
90...264 V AC/ 135...340 V DC	90...264 V AC/ 135...340 V DC	90...264 V AC/ 135...340 V DC
< 30 A	< 30 A	< 20 A
48...62 Hz	48...62 Hz	48...62 Hz
6.3 A/250 V AC internal	6.3 A/250 V AC internal	6.3 A/250 V AC internal
24 V DC fixed adjustment	24 V DC fixed adjustment	24 V DC fixed adjustment
±0.03%/°C	±0.03%/°C	±0.03%/°C
> 200 ms at 230 V AC/> 40 ms at 115 V AC	> 200 ms at 230 V AC/> 40 ms at 115 V AC	> 150 ms at 230 V AC/> 20 ms at 115 V AC
Stress level, lifetime, load level	Stress level, lifetime, load level	Stress level, lifetime, load level
150% for 4 s	150% for 4 s	150% for 4 s
High efficiency, typically > 88%	High efficiency, typically > 88%	High efficiency, typically > 90%
3-pin (male)	3-pin (male)	3-pin (male)
5-pin (female) e.g. for Profibus, Profinet, CC-Link modules	4-pin (female) e.g. for DeviceNet, Ethernet/IP modules	4-pin (female) e.g. for DeviceNet, Ethernet/IP modules
Forward characteristic	Forward characteristic	Forward characteristic
-25...+70 °C	-25...+70 °C	-25...+70 °C
-40...+80 °C	-40...+80 °C	-40...+80 °C
Panel, wall, and field mounting	Panel, wall, and field mounting	Panel, wall, and field mounting
IP 67	IP 67	IP 67
-2.5%/°C above +60 °C	-2.5%/°C above +60 °C	-2.5%/°C above +60 °C
Free convection	Free convection	Free convection
Metal, fully potted	Metal, fully potted	Metal, fully potted
15 years	15 years	15 years
2 years	2 years	2 years
1 kg	1 kg	1.65 kg
CE	CE	CE



Power Supplies  
Intelligent power supply units  
Single-phase power supplies  
Three-phase power supplies  
Technical data

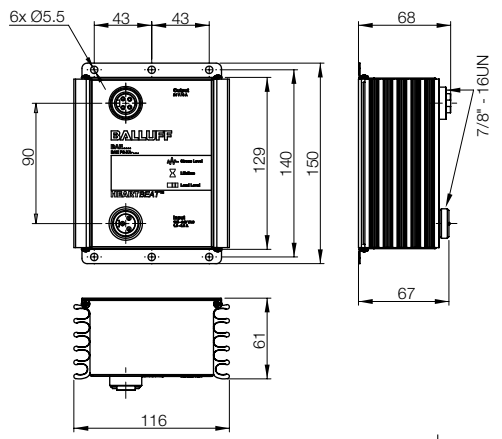
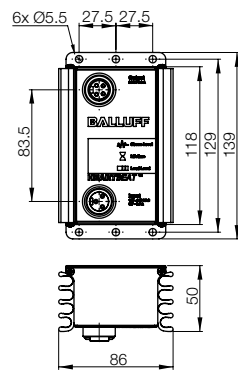
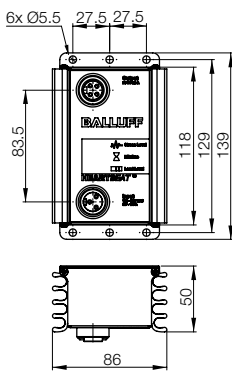

# Power Supplies

## Intelligent devices

### 8 A



Output current	8 A	8 A
Output power	192 W	192 W
Output voltage	24 V DC (SELV)	24 V DC (PELV)
Input voltage	100...240 V AC	100...240 V AC
	Single phase	single-phase
<b>Ordering code</b>	<b>BAE00FL</b>	<b>BAE00FY</b>
Part number	BAE PS-XA-1W-24-080-605	BAE PS-XA-1W-24-080-606
Input voltage range	90...264 V AC/135...340 V AC	90...264 V AC/135...340 V AC
Inrush current	< 20 A	< 20 A
Frequency range	48...62 Hz	48...62 Hz
Input fuse	6.3 A/250 V AC internal	6.3 A/250 V AC internal
Voltage adjustment range	24 V DC fixed adjustment	24 V DC fixed adjustment
Temperature coefficient max.	±0.03%/°C	±0.03%/°C
Hold-up time	> 150 ms at 230 V AC/> 20 ms at 115 V AC	> 150 ms at 230 V AC/> 20 ms at 115 V AC
Status indicator	Stress level, lifetime, load level	Stress level, lifetime, load level
Power boost	150% for 4 s	150% for 4 s
Efficiency	High efficiency, typically > 90%	High efficiency, typically > 90%
Input	3-pin (male)	3-pin (male)
Output	5-pin (female) e.g. for Profibus, Profinet, CC-Link modules	4-pin (female) e.g. for DeviceNet, Ethernet/IP modules
Response	Forward characteristic	Forward characteristic
Ambient temperature range	-25...+70 °C	-25...+70 °C
Storage temperature	-40...+80 °C	-40...+80 °C
Fastener	Panel, wall, and field mounting	Panel, wall, and field mounting
Degree of protection as per IEC 60529	IP 67	IP 67
Derating	-2.5%/°C above +60 °C	-2.5%/°C above +60 °C
Cooling	Free convection	Free convection
Housing material	Metal, fully potted	Metal, fully potted
Service life (at 80% load and 40 °C)	15 years	15 years
Warranty	2 years	2 years
Weight	1.65 kg	1.65 kg
Approvals	CE	CE
Wiring diagram		

\*SELV = Safety Extra Low Voltage

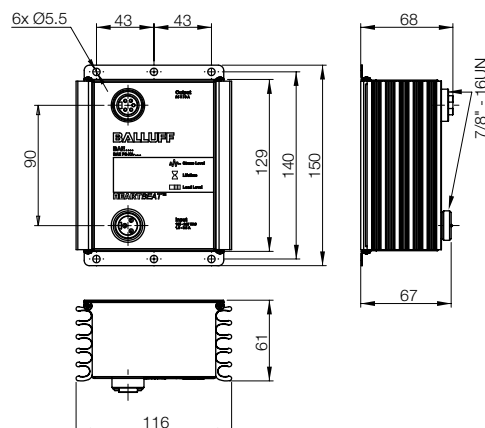



Power Supplies  
**Intelligent power  
supply units**  
Single-phase  
power supplies  
Three-phase  
power supplies  
Technical data

Power Supplies  
**Single-phase input voltage**  
**0.75 A, 1.5 A**

Plastic



Output current	0.75 A	1.5 A																	
Output power	18 W	18 W																	
Output voltage	24 V DC (SELV)	12 V DC (SELV)																	
Input voltage	100...240 V AC	100...240 V AC																	
<b>Ordering code</b>	<b>BAE0001</b>	<b>BAE0036</b>																	
Part number	BAE PS-XA-1W-24-007-001	BAE PS-XA-1W-12-015-001																	
Input voltage range	90...264 V AC/120...375 V DC	90...264 V AC/120...375 V DC																	
Inrush current	115 V AC < 10 A/230 V AC < 18 A	115 V AC < 10 A/230 V AC < 18 A																	
Frequency range	47...63 Hz	47...63 Hz																	
Input fuse	T2 A/250 V AC internal	T2 A/250 V AC internal																	
Voltage adjustment range	22.5...28.5 V DC	11...14 V DC																	
Temperature coefficient max.	±0.03%/°C	±0.03%/°C																	
Ripple and noise	50 mV	50 mV																	
Hold-up time	115 V AC > 20 ms/230 V AC > 30 ms	115 V AC > 20 ms/230 V AC > 30 ms																	
Status indicator DC ON	Green LED	Green LED																	
Status indicator DC LOW	Red LED	Red LED																	
Efficiency	77%	77%																	
Response	Hiccup mode	Hiccup mode																	
Switching frequency	> 100 kHz	> 100 kHz																	
Input/output isolation voltage	3000 V AC	3000 V AC																	
Insulation resistance	100 MΩ	100 MΩ																	
Turn-on delay	< 1 s	< 1 s																	
Ambient temperature range	-20...+70 °C	-20...+70 °C																	
Derating	-2.5%/°C of +61 °C	-2.5%/°C of +61 °C																	
Parallel mode	Yes (with external diodes)	Yes (with external diodes)																	
Degree of protection as per IEC 60529	IP 20	IP 20																	
Ready output	No	No																	
Cooling	Free convection	Free convection																	
Housing material	Plastic	Plastic																	
Weight	0.15 kg	0.15 kg																	
Approvals	CE, UL/cUL, TÜV	CE, UL/cUL, TÜV																	
Wiring diagram	<table border="1"> <tbody> <tr> <td>L, N</td> <td>Input terminals</td> </tr> <tr> <td>PE</td> <td>PE connection</td> </tr> <tr> <td>Vo -</td> <td>Output terminal -</td> </tr> <tr> <td>Vo +</td> <td>Output terminal +</td> </tr> </tbody> </table>	L, N	Input terminals	PE	PE connection	Vo -	Output terminal -	Vo +	Output terminal +	<table border="1"> <tbody> <tr> <td>L, N</td> <td>Input terminals</td> </tr> <tr> <td>PE</td> <td>PE connection</td> </tr> <tr> <td>Vo -</td> <td>Output terminal -</td> </tr> <tr> <td>Vo +</td> <td>Output terminal +</td> </tr> </tbody> </table>	L, N	Input terminals	PE	PE connection	Vo -	Output terminal -	Vo +	Output terminal +	
L, N	Input terminals																		
PE	PE connection																		
Vo -	Output terminal -																		
Vo +	Output terminal +																		
L, N	Input terminals																		
PE	PE connection																		
Vo -	Output terminal -																		
Vo +	Output terminal +																		

\*SELV = Safety Extra Low Voltage

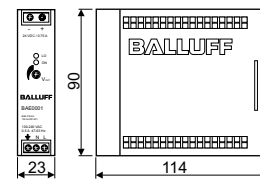
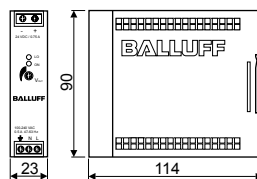

# Power Supplies

## Single-phase input voltage

### 1.25 A, 2.5 A



1.25 A											
30 W											
24 V DC (SELV)											
100...240 V AC											
<b>BAE0004</b>											
BAE PS-XA-1W-24-012-002											
85...264 V AC/90...375 V DC											
115 V AC < 20 A/230 V AC < 40 A											
47...63 Hz											
T2 A/250 V AC internal											
22.5...28.5 V DC											
±0.03%/°C											
50 mV											
115 V AC > 20 ms/230 V AC > 30 ms											
Green LED											
86%											
Forward characteristic											
> 80 kHz											
3000 V AC											
100 MΩ											
< 1 s											
-40...+70 °C											
-2.5%/°C of +61 °C											
Yes (with external diodes)											
IP 20											
DC OK output											
Free convection											
Plastic											
0.29 kg											
CE, UL/cUL, TÜV											
	<table border="1"> <tr><td>L, N</td><td>Input terminals</td></tr> <tr><td>PE</td><td>PE connection</td></tr> <tr><td>Vo -</td><td>Output terminal -</td></tr> <tr><td>Vo +</td><td>Output terminal +</td></tr> <tr><td>Rdy</td><td>Ready output</td></tr> </table>	L, N	Input terminals	PE	PE connection	Vo -	Output terminal -	Vo +	Output terminal +	Rdy	Ready output
L, N	Input terminals										
PE	PE connection										
Vo -	Output terminal -										
Vo +	Output terminal +										
Rdy	Ready output										

2.5 A											
30 W											
12 V DC (SELV)											
100...240 V AC											
<b>BAE0039</b>											
BAE PS-XA-1W-12-025-002											
85...264 V AC/90...375 V DC											
115 V AC < 20 A/230 V AC < 40 A											
47...63 Hz											
T2 A/250 V AC internal											
11...14 V DC											
±0.03%/°C											
50 mV											
115 V AC > 20 ms/230 V AC > 30 ms											
Green LED											
84%											
Forward characteristic											
> 80 kHz											
3000 V AC											
100 MΩ											
< 1 s											
-40...+70 °C											
-2.5%/°C of +61 °C											
Yes (with external diodes)											
IP 20											
DC OK output											
Free convection											
Plastic											
0.29 kg											
CE, UL/cUL, TÜV											
	<table border="1"> <tr><td>L, N</td><td>Input terminals</td></tr> <tr><td>PE</td><td>PE connection</td></tr> <tr><td>Vo -</td><td>Output terminal -</td></tr> <tr><td>Vo +</td><td>Output terminal +</td></tr> <tr><td>Rdy</td><td>Ready output</td></tr> </table>	L, N	Input terminals	PE	PE connection	Vo -	Output terminal -	Vo +	Output terminal +	Rdy	Ready output
L, N	Input terminals										
PE	PE connection										
Vo -	Output terminal -										
Vo +	Output terminal +										
Rdy	Ready output										



Power Supplies  
Intelligent power supply units  
Single-phase power supplies  
Three-phase power supplies  
Technical data

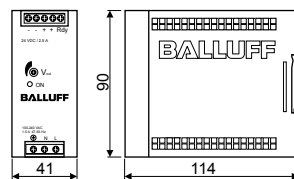
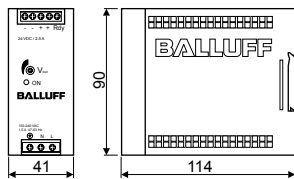



Output current	2.5 A										
Output power	60 W										
Output voltage	24 V DC (SELV)										
Input voltage	100...240 V AC										
<b>Ordering code</b>	<b>BAE0005</b>										
Part number	BAE PS-XA-1W-24-025-002										
Input voltage range	85...264 V AC/90...375 V DC										
Inrush current	115 V AC < 30 A/230 V AC < 60 A										
Frequency range	47...63 Hz										
Input fuse	T2 A/250 V AC internal										
Voltage adjustment range	22.5...28.5 V DC										
Temperature coefficient max.	±0.03%/°C										
Ripple and noise	50 mV										
Hold-up time	115 V AC > 20 ms/230 V AC > 30 ms										
Status indicator DC ON	Green LED										
Status indicator DC LOW											
Efficiency	89%										
Response	Forward characteristic										
Switching frequency	> 55 kHz										
Input/output isolation voltage	3000 V AC										
Insulation resistance	100 MΩ										
Turn-on delay	< 1 s										
Ambient temperature range	-40...+70 °C										
Derating	-2.5%/°C of +61 °C										
Parallel mode	Yes (with external diodes)										
Degree of protection as per IEC 60529	IP 20										
Ready output	DC OK output										
Cooling	Free convection										
Housing material	Plastic										
Weight	0.36 kg										
Approvals	CE, UL/cUL, TÜV										
Wiring diagram	<table border="1" style="margin-left: 20px;"> <tr> <td>L, N</td> <td>Input terminals</td> </tr> <tr> <td>PE</td> <td>PE connection</td> </tr> <tr> <td>Vo -</td> <td>Output terminal -</td> </tr> <tr> <td>Vo +</td> <td>Output terminal +</td> </tr> <tr> <td>Rdy</td> <td>Ready output</td> </tr> </table>	L, N	Input terminals	PE	PE connection	Vo -	Output terminal -	Vo +	Output terminal +	Rdy	Ready output
L, N	Input terminals										
PE	PE connection										
Vo -	Output terminal -										
Vo +	Output terminal +										
Rdy	Ready output										

\*SELV = Safety Extra Low Voltage

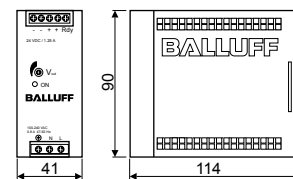

# Power Supplies

## Single-phase input voltage

### 5 A



5 A										
60 W										
12 V DC (SELV)										
100...240 V AC										
<b>BAE003E</b>										
BAE PS-XA-1W-12-050-002										
85...264 V AC/90...375 V DC										
115 V AC < 30 A/230 V AC < 60 A										
47...63 Hz										
T2 A/250 V AC internal										
11...14 V DC										
±0.03%/°C										
50 mV										
115 V AC > 20 ms/230 V AC > 30 ms										
Green LED										
86%										
Forward characteristic										
> 55 kHz										
3000 V AC										
100 MΩ										
< 1 s										
-40...+70 °C										
-2.5%/°C of +61 °C										
Yes (with external diodes)										
IP 20										
DC OK output										
Free convection										
Plastic										
0.36 kg										
CE, UL/cUL, TÜV										
<table border="1" style="margin-left: 20px;"> <tr><td>L, N</td><td>Input terminals</td></tr> <tr><td>PE</td><td>PE connection</td></tr> <tr><td>Vo -</td><td>Output terminal -</td></tr> <tr><td>Vo +</td><td>Output terminal +</td></tr> <tr><td>Rdy</td><td>Ready output</td></tr> </table>	L, N	Input terminals	PE	PE connection	Vo -	Output terminal -	Vo +	Output terminal +	Rdy	Ready output
L, N	Input terminals									
PE	PE connection									
Vo -	Output terminal -									
Vo +	Output terminal +									
Rdy	Ready output									

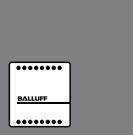

Power Supplies  
 Intelligent power supply units  
 Single-phase power supplies  
 Three-phase power supplies  
 Technical data

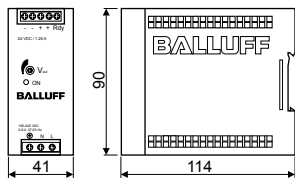

Power Supplies  
**Single-phase input voltage**  
**2.5 A, 3.8 A**

**Metal**



Output current	3.8 A	2.5 A																					
Output power	91.20 W	120 W																					
Output voltage	24 V DC (SELV)	48 V DC (SELV)																					
Input voltage	115/230 V AC (Auto-Select)	115/230 V AC (Auto-Select)																					
<b>Ordering code</b>	<b>BAE003J</b>	<b>BAE003K</b>																					
Part number	BAE PS-XA-1W-24-038-003	BAE PS-XA-1W-48-025-003																					
Input voltage range	90...132 V AC; 180...264 V AC/210...375 V DC	90...132 V AC; 180...264 V AC/210...375 V DC																					
Inrush current	115 V AC < 24 A/230 V AC < 48 A	115 V AC < 24 A/230 V AC < 48 A																					
Frequency range	47...63 Hz	47...63 Hz																					
Input fuse	T3.15 A/250 V AC internal	T3.15 A/250 V AC internal																					
Voltage adjustment range	22.5...24.5 V DC	47...55 V DC																					
Temperature coefficient max.	±0.03%/°C	±0.03%/°C																					
Ripple and noise	50 mV	50 mV																					
Hold-up time	115 V AC > 25 ms/230 V AC > 30 ms	115 V AC > 25 ms/230 V AC > 30 ms																					
Status indicator DC ON	Green LED	Green LED																					
Status indicator DC LOW	Red LED	Red LED																					
Efficiency	86%	87%																					
Response	Forward characteristic	Forward characteristic																					
Switching frequency	> 55 kHz (typically)	> 55 kHz (typically)																					
Input/output isolation voltage	3000 V AC	3000 V AC																					
Insulation resistance	100 MΩ	100 MΩ																					
Turn-on delay	< 1 s	< 1 s																					
Ambient temperature range	-35...+70 °C	-35...+70 °C																					
Derating	-2.5%/°C of +61 °C	-2.5%/°C of +61 °C																					
Parallel mode	No	Yes																					
Degree of protection as per IEC 60529	IP 20	IP 20																					
Ready output	DC OK output relay	DC OK output relay																					
Cooling	Free convection	Free convection																					
Housing material	Metal	Metal																					
Weight	0.92 kg	0.92 kg																					
Approvals	CE, UL/cUL, TÜV, ODVA	CE, UL/cUL, TÜV																					
Wiring diagram	<table border="1"> <tbody> <tr> <td>L, N</td> <td>Input terminals</td> </tr> <tr> <td>PE</td> <td>PE connection</td> </tr> <tr> <td>Vo -</td> <td>Output terminal -</td> </tr> <tr> <td>Vo +</td> <td>Output terminal +</td> </tr> <tr> <td>Rdy</td> <td>Ready output</td> </tr> </tbody> </table>	L, N	Input terminals	PE	PE connection	Vo -	Output terminal -	Vo +	Output terminal +	Rdy	Ready output	<table border="1"> <tbody> <tr> <td>L, N</td> <td>Input terminals</td> </tr> <tr> <td>PE</td> <td>PE connection</td> </tr> <tr> <td>Vo -</td> <td>Output terminal -</td> </tr> <tr> <td>Vo +</td> <td>Output terminal +</td> </tr> <tr> <td>Rdy</td> <td>Ready output</td> </tr> </tbody> </table>	L, N	Input terminals	PE	PE connection	Vo -	Output terminal -	Vo +	Output terminal +	Rdy	Ready output	
L, N	Input terminals																						
PE	PE connection																						
Vo -	Output terminal -																						
Vo +	Output terminal +																						
Rdy	Ready output																						
L, N	Input terminals																						
PE	PE connection																						
Vo -	Output terminal -																						
Vo +	Output terminal +																						
Rdy	Ready output																						

\*SELV = Safety Extra Low Voltage

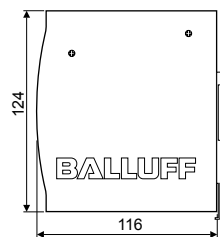
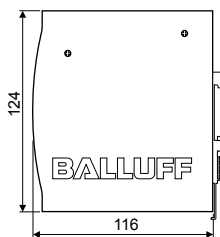
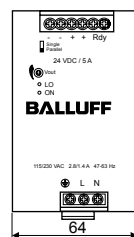



# Power Supplies

## Single-phase input voltage

### 5 A, 10 A



5 A	10 A																				
120 W	120 W																				
24 V DC (SELV)	12 V DC (SELV)																				
115/230 V AC (Auto-Select)	115/230 V AC (Auto-Select)																				
<b>BAE0006</b>	<b>BAE003H</b>																				
BAE PS-XA-1W-24-050-003	BAE PS-XA-1W-12-100-003																				
90...132 V AC; 180...264 V AC/210...375 V DC	90...132 V AC; 180...264 V AC/210...375 V DC																				
115 V AC < 24 A/230 V AC < 48 A	115 V AC < 24 A/230 V AC < 48 A																				
47...63 Hz	47...63 Hz																				
T3.15 A/250 V AC internal	T3.15 A/250 V AC internal																				
22.5...28.5 V DC	11...14 V DC																				
±0.03%/°C	±0.03%/°C																				
50 mV	50 mV																				
115 V AC > 25 ms/230 V AC > 30 ms	115 V AC > 25 ms/230 V AC > 30 ms																				
Green LED	Green LED																				
Red LED	Red LED																				
86%	84%																				
Forward characteristic	Forward characteristic																				
> 55 kHz (typically)	> 55 kHz (typically)																				
3000 V AC	3000 V AC																				
100 MΩ	100 MΩ																				
< 1 s	< 1 s																				
-35...+70 °C	-35...+70 °C																				
-2.5%/°C of +61 °C	-2.5%/°C of +61 °C																				
Yes	Yes																				
IP 20	IP 20																				
DC OK output relay	DC OK output relay																				
Free convection	Free convection																				
Metal	Metal																				
0.92 kg	0.92 kg																				
CE, UL/cUL, TÜV	CE, UL/cUL, TÜV																				
<table border="1"> <tbody> <tr><td>L, N</td><td>Input terminals</td></tr> <tr><td>PE</td><td>PE connection</td></tr> <tr><td>Vo -</td><td>Output terminal -</td></tr> <tr><td>Vo +</td><td>Output terminal +</td></tr> <tr><td>Rdy</td><td>Ready output</td></tr> </tbody> </table>	L, N	Input terminals	PE	PE connection	Vo -	Output terminal -	Vo +	Output terminal +	Rdy	Ready output	<table border="1"> <tbody> <tr><td>L, N</td><td>Input terminals</td></tr> <tr><td>PE</td><td>PE connection</td></tr> <tr><td>Vo -</td><td>Output terminal -</td></tr> <tr><td>Vo +</td><td>Output terminal +</td></tr> <tr><td>Rdy</td><td>Ready output</td></tr> </tbody> </table>	L, N	Input terminals	PE	PE connection	Vo -	Output terminal -	Vo +	Output terminal +	Rdy	Ready output
L, N	Input terminals																				
PE	PE connection																				
Vo -	Output terminal -																				
Vo +	Output terminal +																				
Rdy	Ready output																				
L, N	Input terminals																				
PE	PE connection																				
Vo -	Output terminal -																				
Vo +	Output terminal +																				
Rdy	Ready output																				

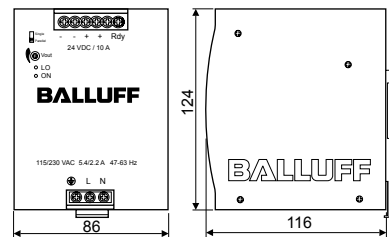
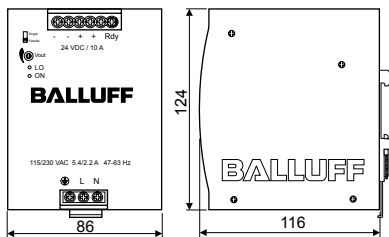

Power Supplies  
Intelligent power supply units  
**Single-phase power supplies**  
Three-phase power supplies  
Technical data

Power Supplies  
Single-phase input voltage  
5 A, 10 A

Metal



Output current	5 A	10 A																					
Output power	240 W	240 W																					
Output voltage	48 V DC (SELV)	24 V DC (SELV)																					
Input voltage	115/230 V AC (Auto-Select)	115/230 V AC (Auto-Select)																					
<b>Ordering code</b>	<b>BAE003L</b>	<b>BAE0002</b>																					
Part number	BAE PS-XA-1W-48-050-004	BAE PS-XA-1W-24-100-004																					
Input voltage range	90...132 V AC; 180...264 V AC/210...375 V DC	90...132 V AC; 180...264 V AC/210...375 V DC																					
Inrush current	115 V AC < 30 A/230 V AC < 60 A	115 V AC < 30 A/230 V AC < 60 A																					
Frequency range	47...63 Hz	47...63 Hz																					
Input fuse	T6.3 A/250 V AC internal	T6.3 A/250 V AC internal																					
Voltage adjustment range	47...55 V DC	22.5...28.5 V DC																					
Temperature coefficient max.	±0.03%/°C	±0.03%/°C																					
Ripple and noise	100 mV	100 mV																					
Hold-up time	115 V AC > 25 ms/230 V AC > 30 ms	115 V AC > 25 ms/230 V AC > 30 ms																					
Status indicator DC ON	Green LED	Green LED																					
Status indicator DC LOW	Red LED	Red LED																					
Efficiency	90%	89%																					
Response	Forward characteristic	Forward characteristic																					
Switching frequency	> 40 kHz (typically)	> 40 kHz (typically)																					
Input/output isolation voltage	3000 V AC	3000 V AC																					
Insulation resistance	100 MΩ	100 MΩ																					
Turn-on delay	< 1 s	< 1 s																					
Ambient temperature range	-40...+70 °C	-40...+70 °C																					
Derating	-2.5%/°C of +61 °C	-2.5%/°C of +61 °C																					
Parallel mode	Yes	Yes																					
Degree of protection as per IEC 60529	IP 20	IP 20																					
Ready output	DC OK output relay	DC OK output relay																					
Cooling	Free convection	Free convection																					
Housing material	Metal	Metal																					
Weight	1.0 kg	1.0 kg																					
Approvals	CE, UL/cUL, TÜV	CE, UL/cUL, TÜV																					
Wiring diagram	<table border="1"> <tbody> <tr> <td>L, N</td> <td>Input terminals</td> </tr> <tr> <td>PE</td> <td>PE connection</td> </tr> <tr> <td>Vo -</td> <td>Output terminal -</td> </tr> <tr> <td>Vo +</td> <td>Output terminal +</td> </tr> <tr> <td>Rdy</td> <td>Ready output</td> </tr> </tbody> </table>	L, N	Input terminals	PE	PE connection	Vo -	Output terminal -	Vo +	Output terminal +	Rdy	Ready output	<table border="1"> <tbody> <tr> <td>L, N</td> <td>Input terminals</td> </tr> <tr> <td>PE</td> <td>PE connection</td> </tr> <tr> <td>Vo -</td> <td>Output terminal -</td> </tr> <tr> <td>Vo +</td> <td>Output terminal +</td> </tr> <tr> <td>Rdy</td> <td>Ready output</td> </tr> </tbody> </table>	L, N	Input terminals	PE	PE connection	Vo -	Output terminal -	Vo +	Output terminal +	Rdy	Ready output	
L, N	Input terminals																						
PE	PE connection																						
Vo -	Output terminal -																						
Vo +	Output terminal +																						
Rdy	Ready output																						
L, N	Input terminals																						
PE	PE connection																						
Vo -	Output terminal -																						
Vo +	Output terminal +																						
Rdy	Ready output																						

\*SELV = Safety Extra Low Voltage

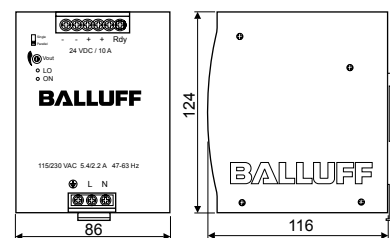
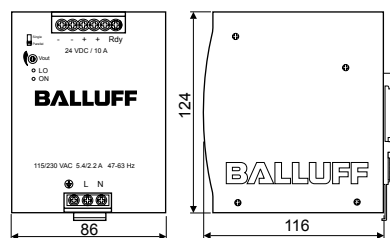

# Power Supplies

## Single-phase input voltage

### 10 A, 20 A



10 A  
 480 W  
 48 V DC (SELV)  
 115/230 V AC (Auto-Select)  
**BAE003M**  
 BAE PS-XA-1W-48-100-005  
 90...264 V AC/120...370 V DC  
 115 V AC < 25 A/230 V AC < 50 A  
 47...63 Hz  
 T10 A/250 V AC internal  
 47...55 V DC  
 ±0.03%/°C  
 100 mV  
 115 V AC > 25 ms/230 V AC > 30 ms  
 Green LED  
 Red LED  
 90%  
 Forward characteristic  
 > 65 kHz (typically)  
 3000 V AC  
 100 MΩ  
 < 1 s  
 -40...+70 °C  
 -2.5%/°C of +56 °C  
 Yes  
 IP 20  
 DC OK output relay  
 Free convection  
 Metal  
 1.92 kg  
 CE, UL/cUL, TÜV

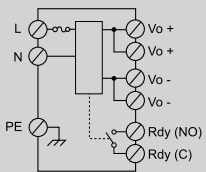

L, N	Input terminals
PE	PE connection
Vo -	Output terminal -
Vo +	Output terminal +
Rdy	Ready output

20 A  
 480 W  
 24 V DC (SELV)  
 115/230 V AC (Auto-Select)  
**BAE0003**  
 BAE PS-XA-1W-24-200-005  
 90...264 V AC/120...370 V DC  
 115 V AC < 25 A/230 V AC < 50 A  
 47...63 Hz  
 T10 A/250 V AC internal  
 22.5...28.5 V DC  
 ±0.03%/°C  
 100 mV  
 115 V AC > 25 ms/230 V AC > 30 ms  
 Green LED  
 Red LED  
 89%  
 Forward characteristic  
 > 65 kHz (typically)  
 3000 V AC  
 100 MΩ  
 < 1 s  
 -40...+70 °C  
 -2.5%/°C of +56 °C  
 Yes  
 IP 20  
 DC OK output relay  
 Free convection  
 Metal  
 1.92 kg  
 CE, UL/cUL, TÜV

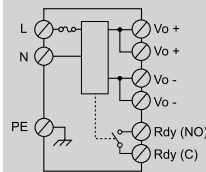

L, N	Input terminals
PE	PE connection
Vo -	Output terminal -
Vo +	Output terminal +
Rdy	Ready output



Power Supplies  
 Intelligent power supply units  
**Single-phase power supplies**  
 Three-phase power supplies  
 Technical data

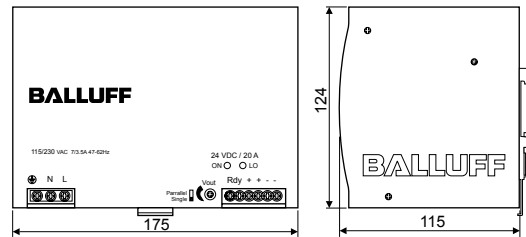
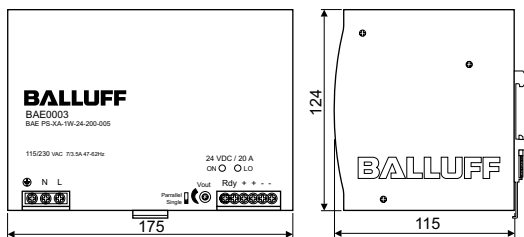



Output current	5 A										
Output power	120 W										
Output voltage	24 V DC (SELV)										
Input voltage	3x 400...500 V AC										
<b>Ordering code</b>	<b>BAE0007</b>										
Part number	BAE PS-XA-3Y-24-050-009										
Input voltage range	340...575 V AC/480...820 V DC										
Inrush current	< 10 A										
Frequency range	47...63 Hz										
Input fuse	2 A/600 V AC internal/phase										
Voltage adjustment range	22.5...28.5 V DC										
Temperature coefficient max.	±0.03%/°C										
Ripple and noise	100 mV										
Hold-up time	> 20 ms										
Status indicator DC ON	Green LED										
Status indicator DC LOW	Red LED										
Efficiency	89%										
Response	Hiccup mode										
Switching frequency	> 65 kHz (typically)										
Input/output isolation voltage	3000 V AC										
Insulation resistance	100 MΩ										
Turn-on delay	< 1 s										
Ambient temperature range	-40...+70 °C										
Derating	-2.5%/°C of +61 °C										
Parallel mode	Yes (with external diodes)										
Degree of protection as per IEC 60529	IP 20										
Ready output	DC OK output relay										
Cooling	Free convection										
Housing material	Metal										
Weight	0.8 kg										
Approvals	CE, UL/cUL, TÜV										
Wiring diagram	<table border="1" style="margin-left: 20px;"> <tr> <td>L</td> <td>Input terminals</td> </tr> <tr> <td>PE</td> <td>PE connection</td> </tr> <tr> <td>Vo -</td> <td>Output terminal -</td> </tr> <tr> <td>Vo +</td> <td>Output terminal +</td> </tr> <tr> <td>Rdy</td> <td>Ready output</td> </tr> </table>	L	Input terminals	PE	PE connection	Vo -	Output terminal -	Vo +	Output terminal +	Rdy	Ready output
L	Input terminals										
PE	PE connection										
Vo -	Output terminal -										
Vo +	Output terminal +										
Rdy	Ready output										

\*SELV = Safety Extra Low Voltage

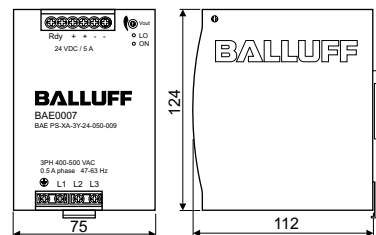

# Power Supplies

## 3-phase input voltage

### 10 A, 20 A



10 A  
240 W  
24 V DC (SELV)  
3x 400...500 V AC  
**BAE0008**  
BAE PS-XA-3Y-24-100-006  
340...575 V AC/480...820 V DC  
< 20 A  
47...63 Hz  
T2 A/600 V AC internal/phase  
22.5...28.5 V DC  
±0.03%/°C  
100 mV  
> 20 ms  
Green LED  
Red LED  
90%  
Hiccup mode  
> 30 kHz (typically)  
3000 V AC  
100 MΩ  
< 1 s  
-40...+70 °C  
-2.5%/°C of +61 °C  
Yes  
IP 20  
DC OK output relay  
Free convection  
Metal  
1.1 kg  
CE, UL/cUL, TÜV

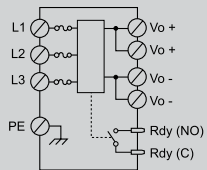

L	Input terminals
PE	PE connection
Vo -	Output terminal -
Vo +	Output terminal +
Rdy	Ready output

20 A  
480 W  
24 V DC (SELV)  
3x 400...500 V AC  
**BAE0009**  
BAE PS-XA-3Y-24-200-007  
340...575 V AC/480...820 V DC  
< 20 A  
47...63 Hz  
3.15 A/500 V AC internal/phase  
22.5...28.5 V DC  
±0.03%/°C  
100 mV  
> 20 ms  
Green LED  
Red LED  
90%  
Forward characteristic (C), restart after 30 s (D),  
Shutoff within 3 s, (C)/(D) togglable  
> 75 kHz (typically)  
3000 V AC  
100 MΩ  
< 1 s  
-30...+70 °C  
-2.5%/°C of +61 °C  
Yes  
IP 20  
DC OK output relay  
Free convection  
Metal  
1.75 kg  
CE, UL/cUL, TÜV

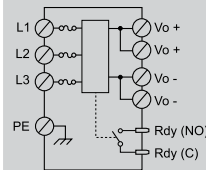

L	Input terminals
PE	PE connection
Vo -	Output terminal -
Vo +	Output terminal +
Rdy	Ready output

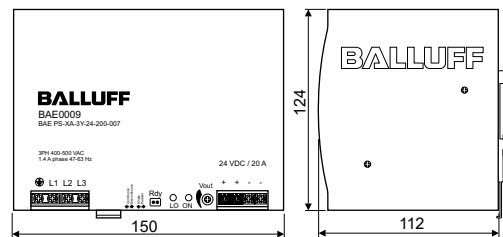
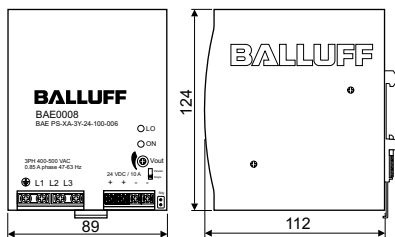

Power Supplies  
Intelligent power supply units  
Single-phase power supplies  
**Three-phase power supplies**  
Technical data



Output current	40 A
Output power	960 W
Output voltage	24 V DC (SELV)
Input voltage	3× 400...500 V AC
<b>Ordering code</b>	<b>BAE003R</b>
Part number	BAE PS-XA-3Y-24-400-010
Input voltage range	340...575 V AC/480...820 V DC
Inrush current	< 30 A
Frequency range	47...63 Hz
Input fuse	T5 A/500 V AC internal/phase
Voltage adjustment range	22.5...28.5 V DC
Temperature coefficient max.	±0.03%/°C
Ripple and noise	80 mV
Hold-up time	> 15 ms
Status indicator DC ON	Green LED
Status indicator DC LOW	Red LED
Efficiency	92%
Response	Hiccup mode
Switching frequency	> 50 kHz (typically)
Input/output isolation voltage	3000 V AC
Insulation resistance	100 MΩ
Turn-on delay	< 1 s
Ambient temperature range	-40...+70 °C
Derating	-3.5%/°C above +61 °C
Parallel mode	Yes
Degree of protection as per IEC 60529	IP 20
Ready output	No
Cooling	Free convection
Housing material	Metal
Weight	3.2 kg
Approvals	CE, UL/cUL, TÜV
Wiring diagram	

\*SELV = Safety Extra Low Voltage

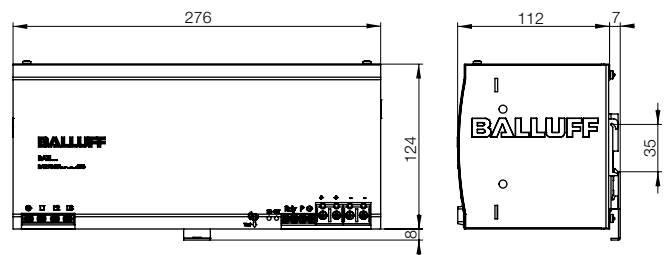

# Power Supplies

## Technical data

### Output short circuit protection

Hiccup mode overload protection\*

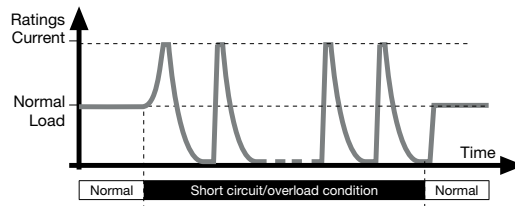

Hiccup mode with turn-off overload protection\*

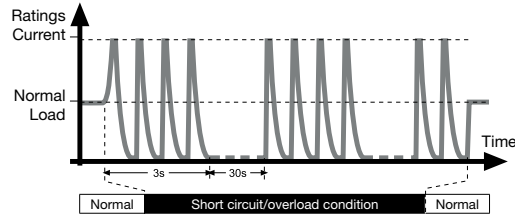

Current limiter and forward characteristic\*

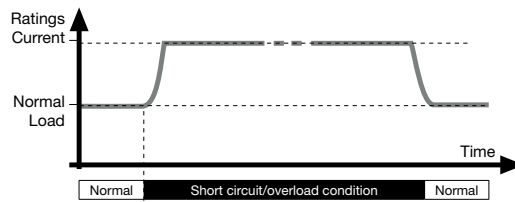

Temperature under-load

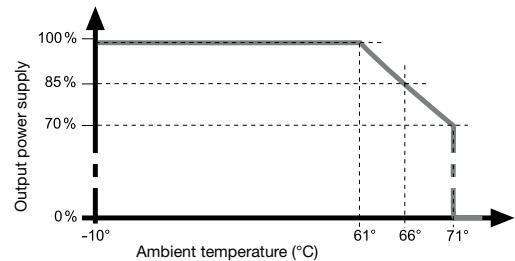

LED definition

DC ON	DC LO	Possible situation
<input type="radio"/> off	<input type="radio"/> off	AC supply off, internal fuse burned out, short circuit
<input checked="" type="radio"/> on	<input type="radio"/> off	Normal operation
<input type="radio"/> off	<input checked="" type="radio"/> on	Output voltage < 19.2 V
<input checked="" type="radio"/> on	<input checked="" type="radio"/> on	Power supply failure

Green | Red

Approvals and standards



UL/cUL  
UL 508 listed/UL 60950-1, UL 1310 Class 2



TÜV  
EN 60950-1



CE  
EN 61000-6-3, EN 55022 Class B, EN 61000-3-2, EN 61000-3-3, EN 61000-6-2, EN 55024, EN 61000-4-2, EN 61000-4-3, EN 61000-4-4, EN 61000-4-5, EN 61000-4-6, EN 61000-4-8, EN 61000-4-11

\*Note: Diagrams are for illustration only. They do not reflect the actual waveforms.

Power Supplies  
Intelligent power supply units  
Single-phase power supplies  
Three-phase power supplies  
Technical data

**Parallel mode\*\***

BAE0002, BAE0003, BAE0006,  
 BAE0008, BAE0009

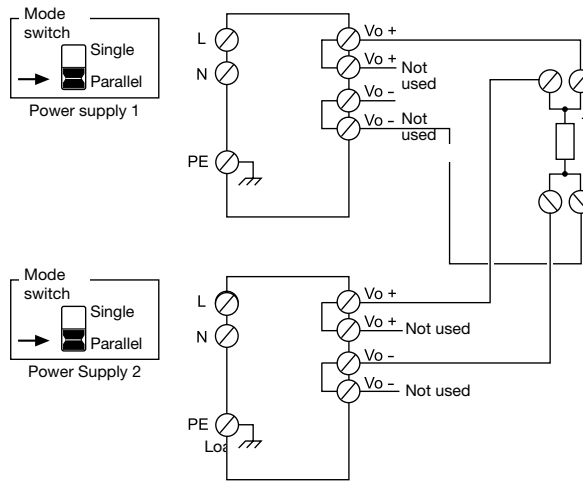

For all without  
 parallel switching mode

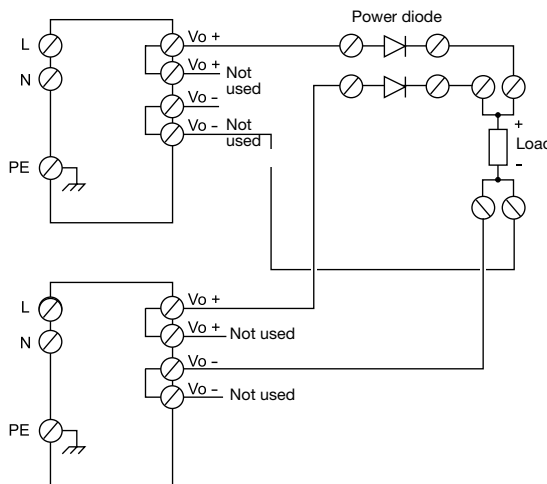

BAE003R

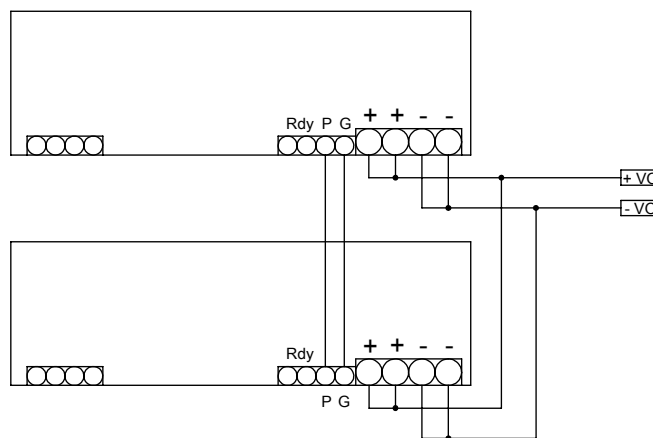

\*\*Note: When wiring power supplies in parallel, the cable lengths should be the same for all DC connections on the load.





Power Supplies  
Intelligent power  
supply units  
Single-phase  
power supplies  
Three-phase  
power supplies  
**Technical data**

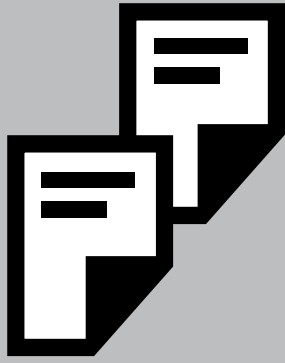

# Basic Information and Definitions



# Basic Information and Definitions

## Contents

Electric properties	386
Quality and the environment	387
Standards	388



### Cable properties

#### Cable types

PUR cable, PUR insulated

Number of conductors × conductor cross-section	Outside diameter typical
3×0.14 mm <sup>2</sup>	2.5...3.5 mm
3×0.25 mm <sup>2</sup>	3.5...4.5 mm
3×0.34 mm <sup>2</sup>	4...5.5 mm
4×0.14 mm <sup>2</sup>	3...4 mm
4×0.34 mm <sup>2</sup>	4...5.5 mm
8×0.25 mm <sup>2</sup>	6...8 mm
12×0.25 mm <sup>2</sup>	6...8 mm
5×0.34 mm <sup>2</sup>	5...6.5 mm
3×1.5 mm <sup>2</sup>	7.8...8.2 mm
4×1.5 mm <sup>2</sup>	7.8...8.2 mm
5×1.5 mm <sup>2</sup>	8.5...8.9 mm

Number of conductors × conductor cross-section	Outside diameter typical
2×0.14 mm <sup>2</sup>	2.5...3.5 mm
2×0.34 mm <sup>2</sup>	4.5...5.5 mm
3×0.14 mm <sup>2</sup>	2.7...4.5 mm
3×0.25 mm <sup>2</sup>	4...5 mm
3×0.34 mm <sup>2</sup>	4.5...5.5 mm
4×0.34 mm <sup>2</sup>	4.6...5.5 mm
5×0.34 mm <sup>2</sup>	5.0...5.5 mm
8×0.25 mm <sup>2</sup>	5.8...6.2 mm

#### Smallest bending radius

Tensioned	Untensioned
10×D	5×D

#### Special cable

The PW-cable is a weld spatter-resistant PUR-cable that has good resistance to weld splatter. A special connection cable is used for sensors that need to be used at higher ambient temperatures.

#### Tightening torques

The permitted tightening torque is indicated in the data sheets for the modules.

#### Current load capacity

M5	3 and 4-pin	1 A
M8	3 and 4-pin	4 A
M12	3 and 5-pin	4 A
M12	8-pin	2 A
M12	12-pin	1 A
7/8"	3 and 5-pin	9 A

#### Color code

Braun, BN	Gray/Pink, GYPK
White, WH	Red/Blue, RDBU
Blue, BU	White/Green, WHGN
Black, BK	Brown/Green, BNGN
Green, GN	Green/Yellow, GNYE
Gray, GY	White/Yellow, WHYE
Orange, OG	White/Gray, WHGY
Pink, PK	Yellow/Brown, YEBN
Purple, YF	Gray/Brown, GYBN

### Quality and the environment

#### Quality management system as per DIN EN ISO 9001:2008

Balluff companies	
Balluff GmbH	Germany
Balluff SIE Sensorik GmbH	Germany
Balluff Controles Eléctricos Ltda.	Brazil
Balluff Sensors (Chengdu) Co., Ltd.	China
Balluff Ltd.	Great Britain
Balluff Automation s.r.l.	Italy
Balluff Canada Inc.	Canada
Balluff de México S.A. de C.V.	Mexico
Balluff GmbH	Austria
Balluff Sp. z o.o.	Poland
Balluff Hy-Tech AG	Switzerland
Balluff Sensortechnik AG	Switzerland
Balluff S.L.	Spain
Balluff CZ, s.r.o	Czech Republic
Balluff Elektronika Kft.	Hungary
Balluff Inc.	USA



#### Environmental management system as per DIN EN ISO 14001:2009

Balluff companies	
Balluff GmbH	Germany
Balluff Sensors (Chengdu) Co., Ltd.	China
Balluff Elektronika Kft	Hungary

#### Testing laboratory

The Balluff testing laboratory operates in accordance with ISO/IEC 17025 and is accredited by DAKks for testing electromagnetic compatibility (EMC).



#### Balluff products comply with EU directives

Products that require labeling are subject to a conformity evaluation process according to the EU directive and the product is labeled with the CE marking.

Balluff products fall under the following EU directive:

2004/108/EC	EMC directive
2006/95/EC	Low Voltage Directive valid for products with supply voltage $\geq 75 \text{ V DC} / \geq 50 \text{ V AC}$
94/9/EC	ATEX-directive valid for products with Ex-label



#### Product approvals

Product approvals are awarded by domestic and international institutions. Their symbols affirm that our products meet the specifications of these institutions.

"US Safety System" and "Canadian Standards Association" under the auspices of Underwriters Laboratories Inc. (cUL).

CCC-Code by the Chinese CQC.



### Standards

<b>Protection class</b>	II □	EN 60947-5-2/IEC 60947-5-2
<b>Degree of protection</b>	IP 60...67 IP 68 per BWN Pr. 20	EN 60529/IEC 60529 Balluff factory standard (BWN): Temperature storage 48 h at 60 °C, 8 temperature cycles according to EN 60068-2-14/IEC 60068-2-14 between the benchmark temperatures according to the data sheet, 1 h storage in water, insulation inspection, 24 h storage in water, insulation test, 8 temperature cycles according to EN 60068-2-14 IEC 60068-2-14 between the benchmark temperatures according to the data sheet, 7 days storage in water, insulation test.
	P 68 according to BWN Pr. 27	Balluff Factory Standard (BWN): Test for products used in the foods industry
	IP 69K	DIN 40050 Part 9: Protection against ingress of water at high-pressure and steam cleaning
<b>EMC (Electromagnetic Compatibility)</b>	Emissions, RF noise voltage and RF noise radiation from electrical equipment	EN 55011
	Static discharge immunity (ESD)	EN 61000-4-2/IEC 61000-4-2
	Radio frequency immunity against high-frequency electromagnetic fields (RFI)	EN 61000-4-3/IEC 61000-4-3
	Immunity to fast transients (bursts)	EN 61000-4-4/IEC 61000-4-4
	Interference immunity against conducted interference, induced by high-frequency fields	EN 61000-4-6/IEC 61000-4-6
	Immunity to voltage dips and voltage interruptions	EN 61000-4-11/IEC 61000-4-11
	Surge-voltage stability	EN 60947-5-2/IEC 60947-5-2
<b>Environmental simulation</b>	Vibration, sinusoidal	EN 60068-2-6/IEC 60068-2-6
	Shock	EN 60068-2-27/IEC 60068-2-27
	Continuous shock	EN 60068-2-29/IEC 60068-2-29
<b>EX area</b>	Electrical equipment for explosive atmospheres, general requirements	EN 50014
	Succeeded by: Electrical equipment for gas explosive atmospheres, general requirements	EN 60079-0
	Electrical apparatus for explosive areas – intrinsic safety "i"	EN 50020

For conformity, see product marking.

# Basic Information and Definitions

## Standards

### Mounting torques

The following torques are to be followed so that the sensors are not mechanically destroyed during installation, as long as no other information is indicated on the data sheet or the sensor packaging.

Size	Material	Tightening torque
M5×0.5	Stainless steel	3 Nm
M8 × 1	Stainless steel	15 Nm
M12×1	Stainless steel	40 Nm
M18×1	PBT	1 Nm
M18×1	Stainless steel	60 Nm
M30×1.5	PBT	3 Nm
M30×1.5	Stainless steel	90 Nm

### Degree of protection

The degrees of protection are given according to IEC 60529. Code letters IP (International Protection) designate protection for electrical equipment against shock hazard, ingress of solid foreign bodies and water

#### IP 69K

Protection against ingress of water at high pressure and steam cleaning per DIN 40050 Part 9

#### First digit:

- 2 Protection against penetration of solid bodies larger than 12 mm, shielding from fingers and objects
- 4 Protection against penetration of solid bodies larger than 1 mm, shielding from tools and wires
- 5 Protection against damaging dust deposits, complete contact protection
- 6 Protection against penetration of dust, complete contact protection

#### Second digit:

- 0 No special protection
- 4 Protection against water, which is sprayed from all directions against the equipment
- 5 Protection against a stream of water from a nozzle which hits the equipment from all directions
- 7 Protection against water, if the equipment (housing) is temporarily submerged
- 8 Protection against water when submerged for some time



Basic Information and Definitions  
 Electric properties  
 Quality and the environment  
**Standards**  
 Mechanical properties

# Alphanumerical index

## Sorted by part number

Part number	Ordering code	Page
<b>BAE</b>		
BAE PS-XA-1W-12-015-001	<b>BAE0036</b>	370
BAE PS-XA-1W-12-025-002	<b>BAE0039</b>	371
BAE PS-XA-1W-12-050-002	<b>BAE003E</b>	373
BAE PS-XA-1W-12-100-003	<b>BAE003H</b>	375
BAE PS-XA-1W-24-007-001	<b>BAE0001</b>	370
BAE PS-XA-1W-24-012-002	<b>BAE0004</b>	371
BAE PS-XA-1W-24-025-002	<b>BAE0005</b>	372
BAE PS-XA-1W-24-038-003	<b>BAE003J</b>	374
BAE PS-XA-1W-24-038-601	<b>BAE00EN</b>	366
BAE PS-XA-1W-24-038-602	<b>BAE00EP</b>	366
BAE PS-XA-1W-24-038-603	<b>BAE00ER</b>	367
BAE PS-XA-1W-24-038-607	<b>BAE00FW</b>	367
BAE PS-XA-1W-24-050-003	<b>BAE0006</b>	375
BAE PS-XA-1W-24-050-013	<b>BAE00EK</b>	365
BAE PS-XA-1W-24-080-604	<b>BAE00ET</b>	367
BAE PS-XA-1W-24-080-605	<b>BAE00FL</b>	368
BAE PS-XA-1W-24-080-606	<b>BAE00FY</b>	368
BAE PS-XA-1W-24-100-004	<b>BAE0002</b>	376
BAE PS-XA-1W-24-100-014	<b>BAE00EU</b>	365
BAE PS-XA-1W-24-200-005	<b>BAE0003</b>	377
BAE PS-XA-1W-48-025-003	<b>BAE003K</b>	374
BAE PS-XA-1W-48-050-004	<b>BAE003L</b>	376
BAE PS-XA-1W-48-100-005	<b>BAE003M</b>	377
BAE PS-XA-3Y-24-050-009	<b>BAE0007</b>	378
BAE PS-XA-3Y-24-100-006	<b>BAE0008</b>	379
BAE PS-XA-3Y-24-200-007	<b>BAE0009</b>	379
BAE PS-XA-3Y-24-400-010	<b>BAE003R</b>	380

<b>BAM</b>		
BAM CS-XA-001-M8-C	<b>BAM01C1</b>	191, 259
BAM CS-XA-002-M12-A	<b>BAM01C2</b>	39, 59, 71, 91, 123, 191, 259
BAM FK-NI-PBS-01-C	<b>BAM01JO</b>	39, 90
BAM IA-CC-002-01		39, 59, 70, 90, 122, 191, 327
BAM TO-CC-001-A3-1.5/24.0	<b>BAM00ZN</b>	327
BAM TO-CC-001-M3-0.4/8.0	<b>BAM00ZL</b>	327
BAM TO-CC-001-M4-0.6/12.0	<b>BAM00ZM</b>	327
BAM TO-CC-002-M6	<b>BAM01TY</b>	327
BAW M18MI-BLC50B-S04G	<b>BAW002F</b>	160

<b>BAW</b>		
BAW Z01AC-BLD50B-DP03	<b>BAW003A</b>	161

<b>BCC</b>		
BCC A314-0000-10-003-PX04A5-020	<b>BCC06HU</b>	83, 117
BCC A314-0000-10-003-PX04A5-050	<b>BCC06HW</b>	83, 117
BCC A314-0000-10-003-PX04A5-100	<b>BCC06HY</b>	83, 117
BCC A314-000-20-003-PX04A5-020	<b>BCC06HL</b>	82, 116
BCC A314-000-20-003-PX04A5-050	<b>BCC06HM</b>	82, 116
BCC A314-000-20-003-PX04A5-100	<b>BCC06HN</b>	82, 116
BCC A314-A314-30-304-PX04A5-006	<b>BCC06J2</b>	84, 118
BCC A314-A314-30-304-PX04A5-020	<b>BCC06J3</b>	84, 118
BCC A314-A314-30-304-PX04A5-050	<b>BCC06J4</b>	84, 118
BCC A314-A314-30-304-PX04A5-100	<b>BCC06J5</b>	84, 118
BCC A314-A314-30-304-PX04A5-150	<b>BCC06J6</b>	84, 118
BCC A314-A314-A314-T0022-000	<b>BCC0AA6</b>	88, 114
BCC A314-A324-30-304-PX04A5-006	<b>BCC06J7</b>	84, 118
BCC A314-A324-30-304-PX04A5-020	<b>BCC06J8</b>	84, 118
BCC A314-A324-30-304-PX04A5-050	<b>BCC06J9</b>	84, 118
BCC A314-A324-30-304-PX04A5-100	<b>BCC06JA</b>	84, 118

Part number	Ordering code	Page
BCC A314-A324-30-304-PX04A5-150	<b>BCC06JC</b>	84, 118
BCC A315-0000-10-030-VS85N6-020	<b>BCC09UY</b>	80
BCC A315-0000-10-030-VS85N6-050	<b>BCC09W0</b>	80
BCC A315-0000-10-030-VS85N6-100	<b>BCC09W3</b>	80
BCC A315-0000-10-063-PX05A5-020	<b>BCC06HC</b>	28, 48, 66
BCC A315-0000-10-063-PX05A5-050	<b>BCC06HE</b>	28, 48, 66
BCC A315-0000-10-063-PX05A5-100	<b>BCC06HF</b>	28, 48, 66
BCC A315-0000-1A-R04	<b>BCC0A0A</b>	86
BCC A315-0000-20-030-VS85N6-020	<b>BCC09W8</b>	80
BCC A315-0000-20-030-VS85N6-050	<b>BCC09WA</b>	80
BCC A315-0000-20-030-VS85N6-100	<b>BCC09WF</b>	80
BCC A315-0000-2A-R04	<b>BCC0A09</b>	86
BCC A315-A315-30-330-VS85N6-006	<b>BCC09YA</b>	80
BCC A315-A315-30-330-VS85N6-020	<b>BCC09YE</b>	80
BCC A315-A315-30-330-VS85N6-050	<b>BCC09YJ</b>	80
BCC A315-A315-30-330-VS85N6-100	<b>BCC09YP</b>	80
BCC A315-A315-30-330-VS85N6-150	<b>BCC09YT</b>	80
BCC A315-A315-30-335-PX05A5-006	<b>BCC06FM</b>	29, 49, 67
BCC A315-A315-30-335-PX05A5-020	<b>BCC06FN</b>	29, 49, 67
BCC A315-A315-30-335-PX05A5-050	<b>BCC06FP</b>	29, 49, 67
BCC A315-A315-30-335-PX05A5-100	<b>BCC06FR</b>	29, 49, 67
BCC A315-A315-30-335-PX05A5-150	<b>BCC06FT</b>	29, 49, 67
BCC A315-A315-A315-T0023-000	<b>BCC0AA7</b>	36, 57, 70, 87
BCC A315-A325-30-335-PX05A5-006	<b>BCC06FU</b>	29, 49, 67
BCC A315-A325-30-335-PX05A5-020	<b>BCC06FW</b>	29, 49, 67
BCC A315-A325-30-335-PX05A5-050	<b>BCC06FY</b>	29, 49, 67
BCC A315-A325-30-335-PX05A5-100	<b>BCC06FZ</b>	29, 49, 67
BCC A315-A325-30-335-PX05A5-150	<b>BCC06HO</b>	29, 49, 67
BCC A324-0000-10-003-PX04A5-020	<b>BCC06HZ</b>	83, 117
BCC A324-0000-10-003-PX04A5-050	<b>BCC06JO</b>	83, 117
BCC A324-0000-10-003-PX04A5-100	<b>BCC06J1</b>	83, 117
BCC A324-0000-20-003-PX04A5-020	<b>BCC06HP</b>	82, 116
BCC A324-0000-20-003-PX04A5-050	<b>BCC06HR</b>	82, 116
BCC A324-0000-20-003-PX04A5-100	<b>BCC06HT</b>	82, 116
BCC A324-A314-30-304-PX04A5-006	<b>BCC06JE</b>	85, 119
BCC A324-A314-30-304-PX04A5-020	<b>BCC06JF</b>	85, 119
BCC A324-A314-30-304-PX04A5-050	<b>BCC06JH</b>	85, 119
BCC A324-A314-30-304-PX04A5-100	<b>BCC06JJ</b>	85, 119
BCC A324-A314-30-304-PX04A5-150	<b>BCC06JK</b>	85, 119
BCC A324-A324-30-304-PX04A5-006	<b>BCC06JL</b>	85, 119
BCC A324-A324-30-304-PX04A5-020	<b>BCC06JM</b>	85, 119
BCC A324-A324-30-304-PX04A5-050	<b>BCC06JN</b>	85, 119
BCC A324-A324-30-304-PX04A5-100	<b>BCC06JP</b>	85, 119
BCC A324-A324-30-304-PX04A5-150	<b>BCC06JR</b>	85, 119
BCC A325-0000-10-063-PX05A5-020	<b>BCC06HH</b>	28, 48, 66
BCC A325-0000-10-063-PX05A5-050	<b>BCC06HJ</b>	28, 48, 66
BCC A325-0000-10-063-PX05A5-100	<b>BCC06HK</b>	28, 48, 66
BCC A325-A315-30-335-PX05A5-006	<b>BCC06H1</b>	29, 49, 67
BCC A325-A315-30-335-PX05A5-020	<b>BCC06H2</b>	29, 49, 67
BCC A325-A315-30-335-PX05A5-050	<b>BCC06H3</b>	29, 49, 67
BCC A325-A315-30-335-PX05A5-100	<b>BCC06H4</b>	29, 49, 67
BCC A325-A315-30-335-PX05A5-150	<b>BCC06H5</b>	29, 49, 67
BCC A325-A325-30-335-PX05A5-006	<b>BCC06H6</b>	29, 49, 67
BCC A325-A325-30-335-PX05A5-020	<b>BCC06H7</b>	29, 49, 67
BCC A325-A325-30-335-PX05A5-050	<b>BCC06H8</b>	29, 49, 67
BCC A325-A325-30-335-PX05A5-100	<b>BCC06H9</b>	29, 49, 67
BCC A325-A325-30-335-PX05A5-150	<b>BCC06HA</b>	29, 49, 67
BCC A334-0000-10-000-51X4A5-000	<b>BCC0706</b>	89, 120
BCC A334-0000-10-000-61X4A5-000	<b>BCC0707</b>	89, 120
BCC A334-0000-10-000-71X4A5-000	<b>BCC0708</b>	89, 120
BCC A334-0000-20-000-51X4A5-000	<b>BCC0709</b>	89, 120
BCC A334-0000-20-000-61X4A5-000	<b>BCC070A</b>	89, 120
BCC A334-0000-20-000-71X4A5-000	<b>BCC070C</b>	89, 120



# Alphanumeric index

## Sorted by part number

Part number	Ordering code	Page	Part number	Ordering code	Page
BCC A335-0000-10-000-51X5A5-000	<b>BCC070E</b>	34, 56	BCC M313-M313-30-300-VX8334-050	<b>BCC02W0</b>	274
BCC A335-0000-10-000-61X5A5-000	<b>BCC070F</b>	34, 56	BCC M313-M313-30-602-PX0334-003	<b>BCC0AZA</b>	274
BCC A335-0000-10-000-71X5A5-000	<b>BCC070H</b>	34, 56	BCC M313-M313-30-602-PX0334-006	<b>BCC0AZC</b>	274
BCC A335-0000-20-000-51X5A5-000	<b>BCC070J</b>	34, 56	BCC M313-M313-30-602-PX0334-010	<b>BCC0AZE</b>	274
BCC A335-0000-20-000-61X5A5-000	<b>BCC070K</b>	34, 56	BCC M313-M313-30-602-PX0334-015	<b>BCC0AZF</b>	274
BCC A335-0000-20-000-71X5A5-000	<b>BCC070L</b>	34, 56	BCC M313-M313-30-602-PX0334-020	<b>BCC0AZH</b>	274
BCC D259-M414-M415-U0029-000-C011	<b>BCC0C0Y</b>	31	BCC M313-M313-30-602-PX0334-030	<b>BCC0AZJ</b>	274
BCC D269-M414-M415-U0029-000-C011	<b>BCC0C0Z</b>	31	BCC M313-M313-30-602-PX0334-050	<b>BCC0AZK</b>	274
BCC D279-0000-E0-000-65X4N1-000-C011	<b>BCC0C10</b>	31	BCC M313-M313-M313-U2017-003	<b>BCC0A07</b>	287
BCC D289-0000-E0-000-65X4N1-000-C011	<b>BCC0C11</b>	31	BCC M313-M323-30-300-PX0334-003	<b>BCC02RE</b>	275
BCC E834-0000-20-000-53X4T2-000	<b>BCC06FH</b>	55, 113	BCC M313-M323-30-300-PX0334-006	<b>BCC02RF</b>	275
BCC E834-E834-90-334-PS54T2-006	<b>BCC04KE</b>	53	BCC M313-M323-30-300-PX0334-010	<b>BCC02RH</b>	275
BCC E834-E834-90-334-PS54T2-020	<b>BCC04KF</b>	53	BCC M313-M323-30-300-PX0334-015	<b>BCC02RJ</b>	275
BCC E834-E834-90-334-PS54T2-050	<b>BCC04KH</b>	53	BCC M313-M323-30-300-PX0334-020	<b>BCC02RK</b>	275
BCC E834-E834-90-334-PS54T2-100	<b>BCC04KJ</b>	53	BCC M313-M323-30-300-PX0334-030	<b>BCC02RL</b>	275
BCC E834-E834-90-334-PS54T2-150	<b>BCC04ZK</b>	53	BCC M313-M323-30-300-PX0334-050	<b>BCC02RM</b>	275
BCC E834-E834-90-334-PS54T2-200	<b>BCC04KK</b>	53	BCC M313-M323-30-300-VX8334-003	<b>BCC02W1</b>	275
BCC E834-E834-90-334-PS54T2-300	<b>BCC04KL</b>	53	BCC M313-M323-30-300-VX8334-006	<b>BCC02W2</b>	275
BCC E834-E834-90-339-ES64N9-006	<b>BCC0CZJ</b>	107	BCC M313-M323-30-300-VX8334-010	<b>BCC02W3</b>	275
BCC E834-E834-90-339-ES64N9-020	<b>BCC0CZK</b>	107	BCC M313-M323-30-300-VX8334-015	<b>BCC02W4</b>	275
BCC E834-E834-90-339-ES64N9-050	<b>BCC0CZL</b>	107	BCC M313-M323-30-300-VX8334-020	<b>BCC02W5</b>	275
BCC E834-E834-90-339-ES64N9-100	<b>BCC0CZM</b>	107	BCC M313-M323-30-300-VX8334-030	<b>BCC02W6</b>	275
BCC E834-E834-90-339-ES64N9-150	<b>BCC0CZN</b>	107	BCC M313-M323-30-300-VX8334-050	<b>BCC02W7</b>	275
BCC E834-E834-90-367-EX64N9-006	<b>BCC0CZP</b>	109	BCC M313-M413-3E-300-PX0334-003	<b>BCC03F4</b>	278
BCC E834-E834-90-367-EX64N9-020	<b>BCC0CZR</b>	109	BCC M313-M413-3E-300-PX0334-006	<b>BCC03F5</b>	278
BCC E834-E834-90-367-EX64N9-050	<b>BCC0CZT</b>	109	BCC M313-M413-3E-300-PX0334-010	<b>BCC03F6</b>	278
BCC E834-E834-90-367-EX64N9-100	<b>BCC0CZU</b>	109	BCC M313-M413-3E-300-PX0334-015	<b>BCC03F7</b>	278
BCC E834-E834-90-367-EX64N9-150	<b>BCC0CNU</b>	109	BCC M313-M413-3E-300-PX0334-020	<b>BCC03F8</b>	278
BCC M313-0000-10-001-PH0334-050	<b>BCC0836</b>	328	BCC M313-M413-3E-300-PX0334-030	<b>BCC03F9</b>	278
BCC M313-0000-10-001-PW0334-050	<b>BCC0AJK</b>	333	BCC M313-M413-3E-300-PX0334-050	<b>BCC03FA</b>	278
BCC M313-0000-10-001-PW0334-100	<b>BCC0CAP</b>	333	BCC M313-M413-3E-300-VX8334-003	<b>BCC03HE</b>	278
BCC M313-0000-10-001-PW3334-050	<b>BCC0C3A</b>	339	BCC M313-M413-3E-300-VX8334-006	<b>BCC03HF</b>	278
BCC M313-0000-10-001-PX0334-020	<b>BCC02M8</b>	270	BCC M313-M413-3E-300-VX8334-010	<b>BCC03HH</b>	278
BCC M313-0000-10-001-PX0334-050	<b>BCC02M9</b>	270	BCC M313-M413-3E-300-VX8334-015	<b>BCC03HJ</b>	278
BCC M313-0000-10-001-PX0334-100	<b>BCC02MA</b>	270	BCC M313-M413-3E-300-VX8334-020	<b>BCC03HK</b>	278
BCC M313-0000-10-001-VX8334-020	<b>BCC02NU</b>	270	BCC M313-M413-3E-300-VX8334-030	<b>BCC03HL</b>	278
BCC M313-0000-10-001-VX8334-050	<b>BCC02NW</b>	270	BCC M313-M413-3E-300-VX8334-050	<b>BCC03HM</b>	278
BCC M313-0000-10-001-VX8334-100	<b>BCC02NY</b>	270	BCC M314-0000-10-003-PW0434-050	<b>BCC0AJM</b>	333
BCC M313-0000-10-004-PX0334-020	<b>BCC0AW9</b>	271	BCC M314-0000-10-003-PW3434-050	<b>BCC0C21</b>	339
BCC M313-0000-10-004-PX0334-050	<b>BCC0AWA</b>	271	BCC M314-0000-10-003-PX0434-020	<b>BCC02N2</b>	272
BCC M313-0000-10-004-PX0334-100	<b>BCC0AWC</b>	271	BCC M314-0000-10-003-PX0434-050	<b>BCC02N3</b>	272
BCC M313-0000-10-004-VX8334-020	<b>BCC0C06</b>	271	BCC M314-0000-10-003-PX0434-100	<b>BCC02N4</b>	272
BCC M313-0000-10-004-VX8334-050	<b>BCC0AY0</b>	271	BCC M314-0000-10-003-VX8434-020	<b>BCC02PL</b>	272
BCC M313-0000-10-004-VX8334-100	<b>BCC0C07</b>	271	BCC M314-0000-10-003-VX8434-050	<b>BCC02PM</b>	272
BCC M313-0000-20-001-PX0334-020	<b>BCC02M2</b>	270	BCC M314-0000-10-003-VX8434-100	<b>BCC02PN</b>	272
BCC M313-0000-20-001-PX0334-050	<b>BCC02M3</b>	270	BCC M314-0000-20-003-PX0434-020	<b>BCC02MU</b>	272
BCC M313-0000-20-001-PX0334-100	<b>BCC02M4</b>	270	BCC M314-0000-20-003-PX0434-050	<b>BCC02MW</b>	272
BCC M313-0000-20-001-VX8334-020	<b>BCC02NL</b>	270	BCC M314-0000-20-003-PX0434-100	<b>BCC02MY</b>	272
BCC M313-0000-20-001-VX8334-050	<b>BCC02NM</b>	270	BCC M314-0000-20-003-VX8434-020	<b>BCC02PC</b>	272
BCC M313-0000-20-001-VX8334-100	<b>BCC02NN</b>	270	BCC M314-0000-20-003-VX8434-050	<b>BCC02PE</b>	272
BCC M313-M313-30-300-PX0334-003	<b>BCC02R5</b>	274	BCC M314-0000-20-003-VX8434-100	<b>BCC02PF</b>	272
BCC M313-M313-30-300-PX0334-006	<b>BCC02R6</b>	274	BCC M314-M313-30-300-PX0334-003	<b>BCC0CAH</b>	276
BCC M313-M313-30-300-PX0334-010	<b>BCC02R7</b>	274	BCC M314-M313-30-300-PX0334-006	<b>BCC0AUL</b>	276
BCC M313-M313-30-300-PX0334-015	<b>BCC02R8</b>	274	BCC M314-M313-30-300-PX0334-010	<b>BCC0A77</b>	276
BCC M313-M313-30-300-PX0334-020	<b>BCC02R9</b>	274	BCC M314-M313-30-300-PX0334-020	<b>BCC0A78</b>	276
BCC M313-M313-30-300-PX0334-030	<b>BCC02RA</b>	274	BCC M314-M313-30-300-PX0334-030	<b>BCC0C6A</b>	276
BCC M313-M313-30-300-PX0334-050	<b>BCC02RC</b>	274	BCC M314-M313-30-300-PX0334-050	<b>BCC0C6C</b>	276
BCC M313-M313-30-300-VX8334-003	<b>BCC02UR</b>	274	BCC M314-M313-M313-U2024-003	<b>BCC0AFL</b>	287
BCC M313-M313-30-300-VX8334-006	<b>BCC02UT</b>	274	BCC M314-M313-M313-U2024-010	<b>BCC0AFM</b>	287
BCC M313-M313-30-300-VX8334-010	<b>BCC02UU</b>	274	BCC M314-M314-30-304-PX0434-003	<b>BCC02TF</b>	276
BCC M313-M313-30-300-VX8334-015	<b>BCC02UW</b>	274	BCC M314-M314-30-304-PX0434-006	<b>BCC02TH</b>	276
BCC M313-M313-30-300-VX8334-020	<b>BCC02UY</b>	274	BCC M314-M314-30-304-PX0434-010	<b>BCC02TJ</b>	276
BCC M313-M313-30-300-VX8334-030	<b>BCC02UZ</b>	274	BCC M314-M314-30-304-PX0434-015	<b>BCC02TK</b>	276

# Alphanumeric index

## Sorted by part number

Part number	Ordering code	Page	Part number	Ordering code	Page
BCC M314-M314-30-304-PX0434-020	<b>BCC02TL</b>	276	BCC M323-M313-30-300-VX8334-020	<b>BCC02WN</b>	275
BCC M314-M314-30-304-PX0434-030	<b>BCC02TM</b>	276	BCC M323-M313-30-300-VX8334-030	<b>BCC02WP</b>	275
BCC M314-M314-30-304-PX0434-050	<b>BCC02TN</b>	276	BCC M323-M313-30-300-VX8334-050	<b>BCC02WR</b>	275
BCC M314-M314-30-304-VX8434-003	<b>BCC02Y2</b>	276	BCC M323-M313-30-602-PX0334-003	<b>BCC02RN</b>	275
BCC M314-M314-30-304-VX8434-006	<b>BCC02Y3</b>	276	BCC M323-M313-30-602-PX0334-006	<b>BCC02RP</b>	275
BCC M314-M314-30-304-VX8434-010	<b>BCC02Y4</b>	276	BCC M323-M313-30-602-PX0334-010	<b>BCC02RR</b>	275
BCC M314-M314-30-304-VX8434-015	<b>BCC02Y5</b>	276	BCC M323-M313-30-602-PX0334-015	<b>BCC02RT</b>	275
BCC M314-M314-30-304-VX8434-020	<b>BCC02Y6</b>	276	BCC M323-M313-30-602-PX0334-020	<b>BCC02RU</b>	275
BCC M314-M314-30-304-VX8434-030	<b>BCC02Y7</b>	276	BCC M323-M313-30-602-PX0334-030	<b>BCC02RW</b>	275
BCC M314-M314-30-304-VX8434-050	<b>BCC02Y8</b>	276	BCC M323-M313-30-602-PX0334-050	<b>BCC02RY</b>	275
BCC M314-M324-30-304-PX0434-003	<b>BCC02TP</b>	277	BCC M323-M313-30-602-VX8334-003	<b>BCC02W8</b>	275
BCC M314-M324-30-304-PX0434-006	<b>BCC02TR</b>	277	BCC M323-M313-30-602-VX8334-006	<b>BCC02W9</b>	275
BCC M314-M324-30-304-PX0434-010	<b>BCC02TT</b>	277	BCC M323-M313-30-602-VX8334-010	<b>BCC02WA</b>	275
BCC M314-M324-30-304-PX0434-015	<b>BCC02TU</b>	277	BCC M323-M313-30-602-VX8334-015	<b>BCC02WC</b>	275
BCC M314-M324-30-304-PX0434-020	<b>BCC02TW</b>	277	BCC M323-M313-30-602-VX8334-020	<b>BCC02WE</b>	275
BCC M314-M324-30-304-PX0434-030	<b>BCC02TY</b>	277	BCC M323-M313-30-602-VX8334-030	<b>BCC02WF</b>	275
BCC M314-M324-30-304-PX0434-050	<b>BCC02TZ</b>	277	BCC M323-M313-30-602-VX8334-050	<b>BCC02WH</b>	275
BCC M314-M324-30-304-VX8434-003	<b>BCC02Y9</b>	277	BCC M323-M413-3E-300-PX0334-003	<b>BCC03FM</b>	278
BCC M314-M324-30-304-VX8434-006	<b>BCC02YA</b>	277	BCC M323-M413-3E-300-PX0334-006	<b>BCC03FN</b>	278
BCC M314-M324-30-304-VX8434-010	<b>BCC02YC</b>	277	BCC M323-M413-3E-300-PX0334-010	<b>BCC03FP</b>	278
BCC M314-M324-30-304-VX8434-015	<b>BCC02YE</b>	277	BCC M323-M413-3E-300-PX0334-015	<b>BCC03FR</b>	278
BCC M314-M324-30-304-VX8434-020	<b>BCC02YF</b>	277	BCC M323-M413-3E-300-PX0334-020	<b>BCC03FT</b>	278
BCC M314-M324-30-304-VX8434-030	<b>BCC02YH</b>	277	BCC M323-M413-3E-300-PX0334-030	<b>BCC03FU</b>	278
BCC M314-M324-30-304-VX8434-050	<b>BCC02YJ</b>	277	BCC M323-M413-3E-300-PX0334-050	<b>BCC03FW</b>	278
BCC M314-M414-3E-304-PX0434-003	<b>BCC03JP</b>	280	BCC M323-M413-3E-300-VX8334-003	<b>BCC03HZ</b>	278
BCC M314-M414-3E-304-PX0434-006	<b>BCC03JR</b>	280	BCC M323-M413-3E-300-VX8334-006	<b>BCC03JO</b>	278
BCC M314-M414-3E-304-PX0434-010	<b>BCC03JT</b>	280	BCC M323-M413-3E-300-VX8334-010	<b>BCC03J1</b>	278
BCC M314-M414-3E-304-PX0434-015	<b>BCC03JU</b>	280	BCC M323-M413-3E-300-VX8334-015	<b>BCC03J2</b>	278
BCC M314-M414-3E-304-PX0434-020	<b>BCC03JW</b>	280	BCC M323-M413-3E-300-VX8334-020	<b>BCC03J3</b>	278
BCC M314-M414-3E-304-PX0434-030	<b>BCC03JY</b>	280	BCC M323-M413-3E-300-VX8334-030	<b>BCC03J4</b>	278
BCC M314-M414-3E-304-PX0434-050	<b>BCC03JZ</b>	280	BCC M323-M413-3E-300-VX8334-050	<b>BCC03J5</b>	278
BCC M314-M414-3E-304-VX8434-003	<b>BCC03L1</b>	280	BCC M323-M413-3E-602-PX0334-003	<b>BCC03H5</b>	279
BCC M314-M414-3E-304-VX8434-006	<b>BCC03L2</b>	280	BCC M323-M413-3E-602-PX0334-006	<b>BCC03H6</b>	279
BCC M314-M414-3E-304-VX8434-010	<b>BCC03L3</b>	280	BCC M323-M413-3E-602-PX0334-010	<b>BCC03H7</b>	279
BCC M314-M414-3E-304-VX8434-015	<b>BCC03L4</b>	280	BCC M323-M413-3E-602-PX0334-015	<b>BCC03H8</b>	279
BCC M314-M414-3E-304-VX8434-020	<b>BCC03L5</b>	280	BCC M323-M413-3E-602-PX0334-020	<b>BCC03H9</b>	279
BCC M314-M414-3E-304-VX8434-030	<b>BCC03L6</b>	280	BCC M323-M413-3E-602-PX0334-030	<b>BCC03HA</b>	279
BCC M314-M414-3E-304-VX8434-050	<b>BCC03L7</b>	280	BCC M323-M413-3E-602-PX0334-050	<b>BCC03HC</b>	279
BCC M323-0000-10-001-PW0334-050	<b>BCC0AJR</b>	333	BCC M323-M413-3E-602-VX8334-003	<b>BCC03JH</b>	279
BCC M323-0000-10-001-PW3334-050	<b>BCC0C24</b>	339	BCC M323-M413-3E-602-VX8334-006	<b>BCC03JF</b>	279
BCC M323-0000-10-001-PX0334-020	<b>BCC02ML</b>	271	BCC M323-M413-3E-602-VX8334-010	<b>BCC03JJ</b>	279
BCC M323-0000-10-001-PX0334-050	<b>BCC02MM</b>	271	BCC M323-M413-3E-602-VX8334-015	<b>BCC03JK</b>	279
BCC M323-0000-10-001-PX0334-100	<b>BCC02MN</b>	271	BCC M323-M413-3E-602-VX8334-020	<b>BCC03JL</b>	279
BCC M323-0000-10-001-VX8334-020	<b>BCC02P5</b>	271	BCC M323-M413-3E-602-VX8334-030	<b>BCC03JM</b>	279
BCC M323-0000-10-001-VX8334-050	<b>BCC02P6</b>	271	BCC M323-M413-3E-602-VX8334-050	<b>BCC03JN</b>	279
BCC M323-0000-10-001-VX8334-100	<b>BCC02P7</b>	271	BCC M324-0000-10-003-PW0434-050	<b>BCC0AJW</b>	333
BCC M323-0000-10-004-PX0334-020	<b>BCC02MH</b>	271	BCC M324-0000-10-003-PW3434-050	<b>BCC0C20</b>	339
BCC M323-0000-10-004-PX0334-050	<b>BCC02MJ</b>	271	BCC M324-0000-10-003-PX0434-020	<b>BCC02NC</b>	273
BCC M323-0000-10-004-PX0334-100	<b>BCC02MK</b>	271	BCC M324-0000-10-003-PX0434-050	<b>BCC02NE</b>	273
BCC M323-0000-10-004-VX8334-020	<b>BCC02P2</b>	271	BCC M324-0000-10-003-PX0434-100	<b>BCC02NF</b>	273
BCC M323-0000-10-004-VX8334-050	<b>BCC02P3</b>	271	BCC M324-0000-10-003-VX8434-020	<b>BCC02PZ</b>	273
BCC M323-0000-10-004-VX8334-100	<b>BCC02P4</b>	271	BCC M324-0000-10-003-VX8434-050	<b>BCC02R0</b>	273
BCC M323-M313-30-300-PX0334-003	<b>BCC02RZ</b>	275	BCC M324-0000-10-003-VX8434-100	<b>BCC02R1</b>	273
BCC M323-M313-30-300-PX0334-006	<b>BCC02T0</b>	275	BCC M324-0000-10-008-PX0434-020	<b>BCC02N8</b>	273
BCC M323-M313-30-300-PX0334-010	<b>BCC02T1</b>	275	BCC M324-0000-10-008-PX0434-050	<b>BCC02N9</b>	273
BCC M323-M313-30-300-PX0334-015	<b>BCC02T2</b>	275	BCC M324-0000-10-008-PX0434-100	<b>BCC02NA</b>	273
BCC M323-M313-30-300-PX0334-020	<b>BCC02T3</b>	275	BCC M324-0000-10-008-VX8434-020	<b>BCC02PU</b>	273
BCC M323-M313-30-300-PX0334-030	<b>BCC02T4</b>	275	BCC M324-0000-10-008-VX8434-050	<b>BCC02PW</b>	273
BCC M323-M313-30-300-PX0334-050	<b>BCC02T5</b>	275	BCC M324-0000-10-008-VX8434-100	<b>BCC02PY</b>	273
BCC M323-M313-30-300-VX8334-003	<b>BCC02WJ</b>	275	BCC M324-M314-30-304-PX0434-003	<b>BCC02U7</b>	277
BCC M323-M313-30-300-VX8334-006	<b>BCC02WK</b>	275	BCC M324-M314-30-304-PX0434-006	<b>BCC02U8</b>	277
BCC M323-M313-30-300-VX8334-010	<b>BCC02WL</b>	275	BCC M324-M314-30-304-PX0434-010	<b>BCC02U9</b>	277
BCC M323-M313-30-300-VX8334-015	<b>BCC02WM</b>	275	BCC M324-M314-30-304-PX0434-015	<b>BCC02UA</b>	277

# Alphanumeric index

## Sorted by part number

Part number	Ordering code	Page	Part number	Ordering code	Page
BCC M324-M314-30-304-PX0434-020	<b>BCC02UC</b>	277	BCC M353-0000-10-RM049-020	<b>BCC0E4Z</b>	289
BCC M324-M314-30-304-PX0434-030	<b>BCC02UE</b>	277	BCC M353-0000-20-RM049-005	<b>BCC0E50</b>	289
BCC M324-M314-30-304-PX0434-050	<b>BCC02UF</b>	277	BCC M353-0000-20-RM049-020	<b>BCC0E51</b>	289
BCC M324-M314-30-304-VX8434-003	<b>BCC02YU</b>	277	BCC M354-0000-10-RM050-005	<b>BCC0E35</b>	289
BCC M324-M314-30-304-VX8434-006	<b>BCC02YW</b>	277	BCC M354-0000-10-RM050-020	<b>BCC0E38</b>	289
BCC M324-M314-30-304-VX8434-010	<b>BCC02YY</b>	277	BCC M354-0000-20-RM050-005	<b>BCC0E2Z</b>	289
BCC M324-M314-30-304-VX8434-015	<b>BCC02YZ</b>	277	BCC M354-0000-20-RM050-020	<b>BCC0E32</b>	289
BCC M324-M314-30-304-VX8434-020	<b>BCC02Z0</b>	277	BCC M412-0000-2B-031-PS72N1-020	<b>BCC0A0Y</b>	30
BCC M324-M314-30-304-VX8434-030	<b>BCC02Z1</b>	277	BCC M412-0000-2B-031-PS72N1-050	<b>BCC0A0Z</b>	30
BCC M324-M314-30-304-VX8434-050	<b>BCC02Z2</b>	277	BCC M412-0000-2B-031-PS72N1-100	<b>BCC0A10</b>	30
BCC M324-M314-30-606-PX0434-003	<b>BCC02U0</b>	277	BCC M413-0000-2A-001-PX0334-020	<b>BCC02ZA</b>	290
BCC M324-M314-30-606-PX0434-006	<b>BCC02U1</b>	277	BCC M413-0000-2A-001-PX0334-050	<b>BCC02ZC</b>	290
BCC M324-M314-30-606-PX0434-010	<b>BCC02U2</b>	277	BCC M413-0000-2A-001-PX0334-100	<b>BCC02ZE</b>	290
BCC M324-M314-30-606-PX0434-015	<b>BCC02U3</b>	277	BCC M413-0000-2A-001-VX8334-020	<b>BCC0334</b>	290
BCC M324-M314-30-606-PX0434-020	<b>BCC02U4</b>	277	BCC M413-0000-2A-001-VX8334-050	<b>BCC0335</b>	290
BCC M324-M314-30-606-PX0434-030	<b>BCC02U5</b>	277	BCC M413-0000-2A-001-VX8334-100	<b>BCC0336</b>	290
BCC M324-M314-30-606-PX0434-050	<b>BCC02U6</b>	277	BCC M413-0000-2A-002-PX0334-020	<b>BCC02ZF</b>	290
BCC M324-M314-30-606-VX8434-003	<b>BCC02YK</b>	277	BCC M413-0000-2A-002-PX0334-050	<b>BCC02ZH</b>	290
BCC M324-M314-30-606-VX8434-006	<b>BCC02YL</b>	277	BCC M413-0000-2A-002-PX0334-100	<b>BCC02ZJ</b>	290
BCC M324-M314-30-606-VX8434-010	<b>BCC02YM</b>	277	BCC M413-0000-2A-002-VX8334-020	<b>BCC0337</b>	290
BCC M324-M314-30-606-VX8434-015	<b>BCC02YN</b>	277	BCC M413-0000-2A-002-VX8334-050	<b>BCC0338</b>	290
BCC M324-M314-30-606-VX8434-020	<b>BCC02YP</b>	277	BCC M413-0000-2A-002-VX8334-100	<b>BCC0339</b>	290
BCC M324-M314-30-606-VX8434-030	<b>BCC02YR</b>	277	BCC M413-0000-2A-036-PS0334-020	<b>BCC02ZK</b>	290
BCC M324-M314-30-606-VX8434-050	<b>BCC02YT</b>	277	BCC M413-0000-2A-036-PS0334-050	<b>BCC02ZL</b>	290
BCC M324-M414-3E-304-PX0434-003	<b>BCC03K7</b>	280	BCC M413-0000-2A-036-PS0334-100	<b>BCC02ZM</b>	290
BCC M324-M414-3E-304-PX0434-006	<b>BCC03K8</b>	280	BCC M413-0000-2A-036-VS8334-020	<b>BCC033A</b>	290
BCC M324-M414-3E-304-PX0434-010	<b>BCC03K9</b>	280	BCC M413-0000-2A-036-VS8334-050	<b>BCC033C</b>	290
BCC M324-M414-3E-304-PX0434-015	<b>BCC03KA</b>	280	BCC M413-0000-2A-036-VS8334-100	<b>BCC033E</b>	290
BCC M324-M414-3E-304-PX0434-020	<b>BCC03KC</b>	280	BCC M413-0000-2A-037-PS0334-020	<b>BCC02ZN</b>	290
BCC M324-M414-3E-304-PX0434-030	<b>BCC03KE</b>	280	BCC M413-0000-2A-037-PS0334-050	<b>BCC02ZP</b>	290
BCC M324-M414-3E-304-PX0434-050	<b>BCC03KF</b>	280	BCC M413-0000-2A-037-PS0334-100	<b>BCC02ZR</b>	290
BCC M324-M414-3E-304-VX8434-003	<b>BCC03LJ</b>	280	BCC M413-0000-2A-037-VS8334-020	<b>BCC033F</b>	290
BCC M324-M414-3E-304-VX8434-006	<b>BCC03LK</b>	280	BCC M413-0000-2A-037-VS8334-050	<b>BCC033H</b>	290
BCC M324-M414-3E-304-VX8434-010	<b>BCC03LL</b>	280	BCC M413-0000-2A-037-VS8334-100	<b>BCC033J</b>	290
BCC M324-M414-3E-304-VX8434-015	<b>BCC03LM</b>	280	BCC M414-0000-2A-003-PX0434-020	<b>BCC031N</b>	294
BCC M324-M414-3E-304-VX8434-020	<b>BCC03LN</b>	280	BCC M414-0000-2A-003-PX0434-050	<b>BCC031P</b>	294
BCC M324-M414-3E-304-VX8434-030	<b>BCC03LP</b>	280	BCC M414-0000-2A-003-PX0434-100	<b>BCC031R</b>	294
BCC M324-M414-3E-304-VX8434-050	<b>BCC03LR</b>	280	BCC M414-0000-2A-003-VX8434-020	<b>BCC035F</b>	294
BCC M324-M414-3E-606-PX0434-003	<b>BCC03KR</b>	281	BCC M414-0000-2A-003-VX8434-050	<b>BCC035H</b>	294
BCC M324-M414-3E-606-PX0434-006	<b>BCC03KT</b>	281	BCC M414-0000-2A-003-VX8434-100	<b>BCC035J</b>	294
BCC M324-M414-3E-606-PX0434-010	<b>BCC03KU</b>	281	BCC M414-0000-2A-014-PS0434-020	<b>BCC031T</b>	294
BCC M324-M414-3E-606-PX0434-015	<b>BCC03KW</b>	281	BCC M414-0000-2A-014-PS0434-050	<b>BCC031U</b>	294
BCC M324-M414-3E-606-PX0434-020	<b>BCC03KY</b>	281	BCC M414-0000-2A-014-PS0434-100	<b>BCC031W</b>	294
BCC M324-M414-3E-606-PX0434-030	<b>BCC03KZ</b>	281	BCC M414-0000-2A-014-VS8434-020	<b>BCC035K</b>	294
BCC M324-M414-3E-606-PX0434-050	<b>BCC03L0</b>	281	BCC M414-0000-2A-014-VS8434-050	<b>BCC035L</b>	294
BCC M324-M414-3E-606-VX8434-003	<b>BCC03M2</b>	281	BCC M414-0000-2A-014-VS8434-100	<b>BCC035M</b>	294
BCC M324-M414-3E-606-VX8434-006	<b>BCC03M3</b>	281	BCC M414-0000-2A-068-VS24N7-020	<b>BCC084R</b>	68
BCC M324-M414-3E-606-VX8434-010	<b>BCC03M4</b>	281	BCC M414-0000-2A-068-VS24N7-050	<b>BCC084T</b>	68
BCC M324-M414-3E-606-VX8434-015	<b>BCC03M5</b>	281	BCC M414-0000-2A-068-VS24N7-100	<b>BCC084U</b>	68
BCC M324-M414-3E-606-VX8434-020	<b>BCC03M6</b>	281	BCC M414-E814-BG-RM013-000	<b>BCC085F</b>	50
BCC M324-M414-3E-606-VX8434-030	<b>BCC03M7</b>	281	BCC M414-E814-BG-RM013-000	<b>BCC085F</b>	110
BCC M324-M414-3E-606-VX8434-050	<b>BCC03M8</b>	281	BCC M414-E834-8G-668-PS54T2-006	<b>BCC04K6</b>	53
BCC M333-0000-10-000-22X334-000	<b>BCC09EU</b>	285	BCC M414-E834-8G-668-PS54T2-020	<b>BCC04K7</b>	53
BCC M333-0000-10-000-31X350-000	<b>BCC06Z1</b>	282	BCC M414-E834-8G-668-PS54T2-050	<b>BCC04K8</b>	53
BCC M333-0000-10-000-34X325-000	<b>BCC06YW</b>	282	BCC M414-E834-8G-668-PS54T2-100	<b>BCC04K9</b>	53
BCC M333-0000-20-000-22X334-000	<b>BCC09EW</b>	285	BCC M414-E834-8G-668-PS54T2-150	<b>BCC04ZJ</b>	53
BCC M333-0000-20-000-31X350-000-C027	<b>BCC0E7N</b>	283	BCC M414-E834-8G-668-PS54T2-200	<b>BCC04KA</b>	53
BCC M333-0000-20-000-34X325-000	<b>BCC06YZ</b>	283	BCC M414-E834-8G-668-PS54T2-300	<b>BCC04KC</b>	53
BCC M334-0000-10-000-22X434-000	<b>BCC09EY</b>	286	BCC M414-E834-8G-672-ES64N9-006	<b>BCC0CZA</b>	107
BCC M334-0000-20-000-22X434-000	<b>BCC09EZ</b>	286	BCC M414-E834-8G-672-ES64N9-020	<b>BCC0CZC</b>	107
BCC M343-0000-10-000-34X325-000	<b>BCC06YY</b>	283	BCC M414-E834-8G-672-ES64N9-050	<b>BCC0CZE</b>	107
BCC M343-0000-20-000-34X325-000	<b>BCC06Z0</b>	283	BCC M414-E834-8G-672-ES64N9-100	<b>BCC0CZF</b>	107
BCC M353-0000-10-RM049-005	<b>BCC0E4Y</b>	289	BCC M414-E834-8G-672-ES64N9-150	<b>BCC0CZH</b>	107



# Alphanumeric index

## Sorted by part number

Part number	Ordering code	Page	Part number	Ordering code	Page
BCC M414-E834-8G-695-EX64N9-006	<b>BCC0E0A</b>	109	BCC M415-0000-1A-003-PH0434-020	<b>BCC0AA9</b>	329
BCC M414-E834-8G-695-EX64N9-020	<b>BCC0E0C</b>	109	BCC M415-0000-1A-003-PH0434-050	<b>BCC0AAA</b>	329
BCC M414-E834-8G-695-EX64N9-050	<b>BCC0CNP</b>	109	BCC M415-0000-1A-003-PH0434-100	<b>BCC0AAC</b>	329
BCC M414-E834-8G-695-EX64N9-100	<b>BCC0CNR</b>	109	BCC M415-0000-1A-003-PW0434-020	<b>BCC0AK4</b>	335
BCC M414-E834-8G-695-EX64N9-150	<b>BCC0CNT</b>	109	BCC M415-0000-1A-003-PW0434-050	<b>BCC0AK5</b>	335
BCC M414-M313-M313-U2026-006	<b>BCC0AFW</b>	326	BCC M415-0000-1A-003-PW0434-100	<b>BCC0AK6</b>	335
BCC M414-M313-M313-U2026-010	<b>BCC0AFY</b>	326	BCC M415-0000-1A-003-PW3434-020	<b>BCC09J6</b>	340
BCC M414-M313-M313-U2026-020	<b>BCC0AFZ</b>	326	BCC M415-0000-1A-003-PW3434-050	<b>BCC0C23</b>	340
BCC M414-M313-M313-U2026-030	<b>BCC0AHO</b>	326	BCC M415-0000-1A-003-PW3434-100	<b>BCC0C7W</b>	340
BCC M414-M414-6D-331-PS54T2-006	<b>BCC04K0</b>	52	BCC M415-0000-1A-003-PX0434-020	<b>BCC032F</b>	295
BCC M414-M414-6D-331-PS54T2-020	<b>BCC04K1</b>	52	BCC M415-0000-1A-003-PX0434-050	<b>BCC032H</b>	295
BCC M414-M414-6D-331-PS54T2-050	<b>BCC04K2</b>	52	BCC M415-0000-1A-003-PX0434-100	<b>BCC032J</b>	295
BCC M414-M414-6D-331-PS54T2-100	<b>BCC04K3</b>	52	BCC M415-0000-1A-003-VX8434-020	<b>BCC0367</b>	295
BCC M414-M414-6D-331-PS54T2-150	<b>BCC04ZH</b>	52	BCC M415-0000-1A-003-VX8434-050	<b>BCC0368</b>	295
BCC M414-M414-6D-331-PS54T2-200	<b>BCC04K4</b>	52	BCC M415-0000-1A-003-VX8434-100	<b>BCC0369</b>	295
BCC M414-M414-6D-331-PS54T2-300	<b>BCC04K5</b>	52	BCC M415-0000-1A-004-PX0334-020	<b>BCC030A</b>	291
BCC M414-M414-6D-338-ES64N9-006	<b>BCC09NL</b>	106	BCC M415-0000-1A-004-PX0334-050	<b>BCC030C</b>	291
BCC M414-M414-6D-338-ES64N9-020	<b>BCC09NN</b>	106	BCC M415-0000-1A-004-PX0334-100	<b>BCC030E</b>	291
BCC M414-M414-6D-338-ES64N9-050	<b>BCC09NP</b>	106	BCC M415-0000-1A-004-VX8334-020	<b>BCC0344</b>	291
BCC M414-M414-6D-338-ES64N9-100	<b>BCC09NR</b>	106	BCC M415-0000-1A-004-VX8334-050	<b>BCC0345</b>	291
BCC M414-M414-6D-338-ES64N9-150	<b>BCC09NT</b>	106	BCC M415-0000-1A-004-VX8334-100	<b>BCC0346</b>	291
BCC M414-M414-6D-366-EX64N9-006	<b>BCC0E08</b>	108	BCC M415-0000-1A-005-PX0334-020	<b>BCC030F</b>	292
BCC M414-M414-6D-366-EX64N9-020	<b>BCC0CLZ</b>	108	BCC M415-0000-1A-005-PX0334-050	<b>BCC030H</b>	292
BCC M414-M414-6D-366-EX64N9-050	<b>BCC0CM1</b>	108	BCC M415-0000-1A-005-PX0334-100	<b>BCC030J</b>	292
BCC M414-M414-6D-366-EX64N9-100	<b>BCC0CM3</b>	108	BCC M415-0000-1A-005-VX8334-020	<b>BCC0347</b>	292
BCC M414-M414-6D-366-EX64N9-150	<b>BCC0E09</b>	108	BCC M415-0000-1A-005-VX8334-050	<b>BCC0348</b>	292
BCC M414-M415-M415-U2027-003	<b>BCC0AK1</b>	337	BCC M415-0000-1A-005-VX8334-100	<b>BCC0349</b>	292
BCC M414-M415-M415-U2027-006	<b>BCC0AK2</b>	337	BCC M415-0000-1A-008-PX0434-020	<b>BCC0327</b>	295
BCC M414-M415-M415-U2027-010	<b>BCC0AK3</b>	337	BCC M415-0000-1A-008-PX0434-050	<b>BCC0328</b>	295
BCC M414-M415-M415-U2027-020	<b>BCC0C27</b>	337	BCC M415-0000-1A-008-PX0434-100	<b>BCC0329</b>	295
BCC M414-M415-M415-U2028-003	<b>BCC0AUA</b>	326	BCC M415-0000-1A-008-VX8434-020	<b>BCC0361</b>	295
BCC M414-M415-M415-U2028-006	<b>BCC0AUC</b>	326	BCC M415-0000-1A-008-VX8434-050	<b>BCC0362</b>	295
BCC M414-M415-M415-U2028-010	<b>BCC0AUE</b>	326	BCC M415-0000-1A-008-VX8434-100	<b>BCC0363</b>	295
BCC M414-M415-M415-U2028-020	<b>BCC0AUF</b>	326	BCC M415-0000-1A-010-PX0434-020	<b>BCC032A</b>	295
BCC M414-M415-M415-U2028-030	<b>BCC0AUH</b>	326	BCC M415-0000-1A-010-PX0434-050	<b>BCC032C</b>	295
BCC M414-M415-M415-U2032-003	<b>BCC0C7A</b>	344	BCC M415-0000-1A-010-PX0434-100	<b>BCC032E</b>	295
BCC M414-M415-M415-U2032-006	<b>BCC0C7C</b>	344	BCC M415-0000-1A-010-VX8434-020	<b>BCC0364</b>	295
BCC M414-M415-M415-U2032-010	<b>BCC0C7E</b>	344	BCC M415-0000-1A-010-VX8434-050	<b>BCC0365</b>	295
BCC M414-M425-M425-U2034-003	<b>BCC0C9U</b>	326	BCC M415-0000-1A-010-VX8434-100	<b>BCC0366</b>	295
BCC M414-M425-M425-U2034-006	<b>BCC0C9T</b>	326	BCC M415-0000-1A-014-PS0434-020	<b>BCC032K</b>	295
BCC M414-M425-M425-U2034-010	<b>BCC0C9R</b>	326	BCC M415-0000-1A-014-PS0434-050	<b>BCC032L</b>	295
BCC M414-M425-M425-U2034-020	<b>BCC0C9P</b>	326	BCC M415-0000-1A-014-PS0434-100	<b>BCC032M</b>	295
BCC M414-M425-M425-U2034-030	<b>BCC0C9N</b>	326	BCC M415-0000-1A-014-VS8434-020	<b>BCC036A</b>	295
BCC M414-M425-M425-U2035-003	<b>BCC0CA2</b>	344	BCC M415-0000-1A-014-VS8434-050	<b>BCC036C</b>	295
BCC M414-M425-M425-U2035-006	<b>BCC0CA3</b>	344	BCC M415-0000-1A-014-VS8434-100	<b>BCC036E</b>	295
BCC M414-M425-M425-U2035-010	<b>BCC0CA4</b>	344	BCC M415-0000-1A-017-PX0534-020	<b>BCC08FE</b>	298
BCC M414-M425-M425-U2035-020	<b>BCC0CA5</b>	344	BCC M415-0000-1A-017-PX0534-050	<b>BCC098C</b>	298
BCC M414-M425-M425-U2035-030	<b>BCC0CA6</b>	344	BCC M415-0000-1A-017-PX0534-100	<b>BCC0860</b>	298
BCC M415-0000-1A-001-PH0334-020	<b>BCC082W</b>	329	BCC M415-0000-1A-017-VX8534-050	<b>BCC0AT5</b>	298
BCC M415-0000-1A-001-PH0334-050	<b>BCC082Y</b>	329	BCC M415-0000-1A-017-VX8534-100	<b>BCC0AN9</b>	298
BCC M415-0000-1A-001-PH0334-100	<b>BCC082Z</b>	329	BCC M415-0000-1A-030-VS85N6-020	<b>BCC0CZW</b>	81
BCC M415-0000-1A-001-PX0334-020	<b>BCC030K</b>	291	BCC M415-0000-1A-030-VS85N6-050	<b>BCC0CZY</b>	81
BCC M415-0000-1A-001-PX0334-050	<b>BCC030L</b>	291	BCC M415-0000-1A-030-VS85N6-100	<b>BCC0CZZ</b>	81
BCC M415-0000-1A-001-PX0334-100	<b>BCC030M</b>	291	BCC M415-0000-2A-030-VS85N6-020	<b>BCC0E00</b>	81
BCC M415-0000-1A-001-VX8334-020	<b>BCC034A</b>	291	BCC M415-0000-2A-030-VS85N6-050	<b>BCC0E01</b>	81
BCC M415-0000-1A-001-VX8334-050	<b>BCC034C</b>	291	BCC M415-0000-2A-030-VS85N6-100	<b>BCC0E02</b>	81
BCC M415-0000-1A-001-VX8334-100	<b>BCC034E</b>	291	BCC M415-0000-1A-034-PW3534-015	<b>BCC087F</b>	341
BCC M415-0000-1A-002-PX0334-020	<b>BCC030N</b>	291	BCC M415-0000-1A-034-PW3534-050	<b>BCC087H</b>	341
BCC M415-0000-1A-002-PX0334-050	<b>BCC030P</b>	291	BCC M415-0000-1A-034-PW3534-075	<b>BCC087J</b>	341
BCC M415-0000-1A-002-PX0334-100	<b>BCC030R</b>	291	BCC M415-0000-1A-034-PW3534-100	<b>BCC087K</b>	341
BCC M415-0000-1A-002-VX8334-020	<b>BCC034F</b>	291	BCC M415-0000-1A-034-PX0534-020	<b>BCC09H4</b>	298
BCC M415-0000-1A-002-VX8334-050	<b>BCC034H</b>	291	BCC M415-0000-1A-034-PX0534-050	<b>BCC09H5</b>	298
BCC M415-0000-1A-002-VX8334-100	<b>BCC034J</b>	291	BCC M415-0000-1A-034-PX0534-100	<b>BCC09H6</b>	298

# Alphanumeric index

## Sorted by part number

Part number	Ordering code	Page	Part number	Ordering code	Page
BCC M415-0000-1A-036-PS0334-020	<b>BCC030T</b>	291	BCC M415-M412-3B-329-PS72N1-010	<b>BCC0A13</b>	30
BCC M415-0000-1A-036-PS0334-050	<b>BCC030U</b>	291	BCC M415-M412-3B-329-PS72N1-020	<b>BCC0A14</b>	30
BCC M415-0000-1A-036-PS0334-100	<b>BCC030W</b>	291	BCC M415-M412-3B-329-PS72N1-050	<b>BCC0A15</b>	30
BCC M415-0000-1A-036-VS8334-020	<b>BCC034K</b>	291	BCC M415-M412-3B-329-PS72N1-100	<b>BCC0A16</b>	30
BCC M415-0000-1A-036-VS8334-050	<b>BCC034L</b>	291	BCC M415-M412-3B-329-PS72N1-150	<b>BCC0A17</b>	30
BCC M415-0000-1A-036-VS8334-100	<b>BCC034M</b>	291	BCC M415-M412-3B-329-PS72N1-200	<b>BCC0A18</b>	30
BCC M415-0000-1A-037-PS0334-020	<b>BCC030Y</b>	291	BCC M415-M413-3A-300-PX0334-003	<b>BCC036Y</b>	308
BCC M415-0000-1A-037-PS0334-050	<b>BCC030Z</b>	291	BCC M415-M413-3A-300-PX0334-006	<b>BCC036Z</b>	308
BCC M415-0000-1A-037-PS0334-100	<b>BCC0310</b>	291	BCC M415-M413-3A-300-PX0334-010	<b>BCC0370</b>	308
BCC M415-0000-1A-037-VS8334-020	<b>BCC034N</b>	291	BCC M415-M413-3A-300-PX0334-015	<b>BCC0371</b>	308
BCC M415-0000-1A-037-VS8334-050	<b>BCC034P</b>	291	BCC M415-M413-3A-300-PX0334-020	<b>BCC0372</b>	308
BCC M415-0000-1A-037-VS8334-100	<b>BCC034R</b>	291	BCC M415-M413-3A-300-PX0334-030	<b>BCC0373</b>	308
BCC M415-0000-1A-068-VS24N7-020	<b>BCC06Y1</b>	68	BCC M415-M413-3A-300-PX0334-050	<b>BCC0374</b>	308
BCC M415-0000-1A-068-VS24N7-050	<b>BCC06Y2</b>	68	BCC M415-M413-3A-300-VX8334-003	<b>BCC0386</b>	308
BCC M415-0000-1A-068-VS24N7-100	<b>BCC06Y3</b>	68	BCC M415-M413-3A-300-VX8334-006	<b>BCC0387</b>	308
BCC M415-0000-1A-R04	<b>BCC0A08</b>	86	BCC M415-M413-3A-300-VX8334-010	<b>BCC0388</b>	308
BCC M415-0000-1B-031-PS72N1-020	<b>BCC070Y</b>	30	BCC M415-M413-3A-300-VX8334-015	<b>BCC0389</b>	308
BCC M415-0000-1B-031-PS72N1-050	<b>BCC070Z</b>	30	BCC M415-M413-3A-300-VX8334-020	<b>BCC038A</b>	308
BCC M415-0000-1B-031-PS72N1-100	<b>BCC0710</b>	30	BCC M415-M413-3A-300-VX8334-030	<b>BCC038C</b>	308
BCC M415-0000-1B-R01	<b>BCC0C6E</b>	37	BCC M415-M413-3A-300-VX8334-050	<b>BCC038E</b>	308
BCC M415-0000-2A-017-PX0534-020	<b>BCC0C76</b>	294	BCC M415-M414-3A-304-PW0434-003	<b>BCC0AP1</b>	336
BCC M415-0000-2A-017-PX0534-050	<b>BCC0C77</b>	294	BCC M415-M414-3A-304-PW0434-006	<b>BCC0AP2</b>	336
BCC M415-0000-2A-017-PX0534-100	<b>BCC0C78</b>	294	BCC M415-M414-3A-304-PW0434-010	<b>BCC0AP3</b>	336
BCC M415-0000-2A-017-VX8534-020	<b>BCC0AU3</b>	294	BCC M415-M414-3A-304-PW0434-015	<b>BCC0AP4</b>	336
BCC M415-0000-2A-017-VX8534-050	<b>BCC0AT6</b>	294	BCC M415-M414-3A-304-PW0434-020	<b>BCC0AP5</b>	336
BCC M415-0000-2A-017-VX8534-100	<b>BCC0AUK</b>	294	BCC M415-M414-3A-304-PW0434-050	<b>BCC0AP7</b>	336
BCC M415-0000-2A-034-PX0534-020	<b>BCC08JE</b>	294	BCC M415-M414-3A-304-PX0434-003	<b>BCC039H</b>	310
BCC M415-0000-2A-034-PX0534-050	<b>BCC08JC</b>	294	BCC M415-M414-3A-304-PX0434-006	<b>BCC039J</b>	310
BCC M415-0000-2A-034-PX0534-100	<b>BCC0JA</b>	294	BCC M415-M414-3A-304-PX0434-010	<b>BCC039K</b>	310
BCC M415-0000-2A-R03	<b>BCC06Y4</b>	70	BCC M415-M414-3A-304-PX0434-015	<b>BCC039L</b>	310
BCC M415-0000-2A-R04	<b>BCC09MR</b>	86	BCC M415-M414-3A-304-PX0434-020	<b>BCC039M</b>	310
BCC M415-0000-2B-R01	<b>BCC0718</b>	36	BCC M415-M414-3A-304-PX0434-030	<b>BCC039N</b>	310
BCC M415-0000-2B-R02	<b>BCC0719</b>	37	BCC M415-M414-3A-304-PX0434-050	<b>BCC039P</b>	310
BCC M415-M313-3F-300-PX0334-003	<b>BCC03M9</b>	304	BCC M415-M414-3A-304-VX8434-003	<b>BCC03C9</b>	310
BCC M415-M313-3F-300-PX0334-006	<b>BCC03MA</b>	304	BCC M415-M414-3A-304-VX8434-006	<b>BCC03CA</b>	310
BCC M415-M313-3F-300-PX0334-010	<b>BCC03MC</b>	304	BCC M415-M414-3A-304-VX8434-010	<b>BCC03CC</b>	310
BCC M415-M313-3F-300-PX0334-015	<b>BCC03ME</b>	304	BCC M415-M414-3A-304-VX8434-015	<b>BCC03CE</b>	310
BCC M415-M313-3F-300-PX0334-020	<b>BCC03MF</b>	304	BCC M415-M414-3A-304-VX8434-020	<b>BCC03CF</b>	310
BCC M415-M313-3F-300-PX0334-030	<b>BCC03MH</b>	304	BCC M415-M414-3A-304-VX8434-030	<b>BCC03CH</b>	310
BCC M415-M313-3F-300-PX0334-050	<b>BCC03MJ</b>	304	BCC M415-M414-3A-304-VX8434-050	<b>BCC03CJ</b>	310
BCC M415-M313-3F-300-VX8334-003	<b>BCC03NW</b>	304	BCC M415-M414-3A-337-VS24N7-006	<b>BCC06WU</b>	68
BCC M415-M313-3F-300-VX8334-006	<b>BCC03NY</b>	304	BCC M415-M414-3A-337-VS24N7-020	<b>BCC06WW</b>	68
BCC M415-M313-3F-300-VX8334-010	<b>BCC03NZ</b>	304	BCC M415-M414-3A-337-VS24N7-050	<b>BCC06WY</b>	68
BCC M415-M313-3F-300-VX8334-015	<b>BCC03P0</b>	304	BCC M415-M414-3A-337-VS24N7-100	<b>BCC06WZ</b>	68
BCC M415-M313-3F-300-VX8334-020	<b>BCC03P1</b>	304	BCC M415-M414-3A-337-VS24N7-150	<b>BCC06Y0</b>	68
BCC M415-M313-3F-300-VX8334-030	<b>BCC03P2</b>	304	BCC M415-M414-3A-606-PX0434-003	<b>BCC03A1</b>	310
BCC M415-M313-3F-300-VX8334-050	<b>BCC03P3</b>	304	BCC M415-M414-3A-606-PX0434-006	<b>BCC03A2</b>	310
BCC M415-M313-M313-U0014-000	<b>BCC09JC</b>	325	BCC M415-M414-3A-606-PX0434-010	<b>BCC03A3</b>	310
BCC M415-M314-3F-304-PX0434-003	<b>BCC03RE</b>	306	BCC M415-M414-3A-606-PX0434-015	<b>BCC03A4</b>	310
BCC M415-M314-3F-304-PX0434-006	<b>BCC03RF</b>	306	BCC M415-M414-3A-606-PX0434-020	<b>BCC03A5</b>	310
BCC M415-M314-3F-304-PX0434-010	<b>BCC03RH</b>	306	BCC M415-M414-3A-606-PX0434-030	<b>BCC03A6</b>	310
BCC M415-M314-3F-304-PX0434-015	<b>BCC03RJ</b>	306	BCC M415-M414-3A-606-PX0434-050	<b>BCC03A7</b>	310
BCC M415-M314-3F-304-PX0434-020	<b>BCC03RK</b>	306	BCC M415-M414-3A-606-VX8434-003	<b>BCC03CU</b>	310
BCC M415-M314-3F-304-PX0434-030	<b>BCC03RL</b>	306	BCC M415-M414-3A-606-VX8434-006	<b>BCC03CW</b>	310
BCC M415-M314-3F-304-PX0434-050	<b>BCC03RM</b>	306	BCC M415-M414-3A-606-VX8434-010	<b>BCC03CY</b>	310
BCC M415-M314-3F-304-VX8434-003	<b>BCC03TP</b>	306	BCC M415-M414-3A-606-VX8434-015	<b>BCC03CZ</b>	310
BCC M415-M314-3F-304-VX8434-006	<b>BCC03TR</b>	306	BCC M415-M414-3A-606-VX8434-020	<b>BCC03E0</b>	310
BCC M415-M314-3F-304-VX8434-010	<b>BCC03TT</b>	306	BCC M415-M414-3A-606-VX8434-030	<b>BCC03E1</b>	310
BCC M415-M314-3F-304-VX8434-015	<b>BCC03TU</b>	306	BCC M415-M414-3A-606-VX8434-050	<b>BCC03E2</b>	310
BCC M415-M314-3F-304-VX8434-020	<b>BCC03TW</b>	306	BCC M415-M415-3A-312-PX0534-003	<b>BCC09FL</b>	312
BCC M415-M314-3F-304-VX8434-030	<b>BCC03TY</b>	306	BCC M415-M415-3A-312-PX0534-006	<b>BCC09FM</b>	312
BCC M415-M314-3F-304-VX8434-050	<b>BCC03TZ</b>	306	BCC M415-M415-3A-312-PX0534-010	<b>BCC09FN</b>	312
BCC M415-M412-3B-329-PS72N1-006	<b>BCC0A12</b>	30	BCC M415-M415-3A-312-PX0534-015	<b>BCC09FP</b>	312

# Alphanumeric index

## Sorted by part number

Part number	Ordering code	Page	Part number	Ordering code	Page
BCC M415-M415-3A-312-PX0534-020	<b>BCC09FR</b>	312	BCC M424-E814-BG-RM013-000	<b>BCC085H</b>	50, 110
BCC M415-M415-3A-312-PX0534-030	<b>BCC09FT</b>	312	BCC M425-0000-1A-001-PH0334-020	<b>BCC0832</b>	329
BCC M415-M415-3A-312-PX0534-050	<b>BCC09FU</b>	312	BCC M425-0000-1A-001-PH0334-050	<b>BCC0833</b>	329
BCC M415-M415-3A-313-PW0534-006	<b>BCC0AJJ</b>	337	BCC M425-0000-1A-001-PH0334-100	<b>BCC0AA8</b>	329
BCC M415-M415-3A-313-PW0534-010	<b>BCC0AK7</b>	337	BCC M425-0000-1A-001-PW3334-020	<b>BCC086T</b>	340
BCC M415-M415-3A-313-PW0534-015	<b>BCC0COM</b>	337	BCC M425-0000-1A-001-PW3334-050	<b>BCC086U</b>	340
BCC M415-M415-3A-313-PW0534-020	<b>BCC0AK8</b>	337	BCC M425-0000-1A-001-PW3334-100	<b>BCC086W</b>	340
BCC M415-M415-3A-313-PW0534-030	<b>BCC0AK9</b>	337	BCC M425-0000-1A-001-PX0334-020	<b>BCC0317</b>	292
BCC M415-M415-3A-313-PW0534-050	<b>BCC0AKA</b>	337	BCC M425-0000-1A-001-PX0334-050	<b>BCC0318</b>	292
BCC M415-M415-3A-313-PW3534-006	<b>BCC087R</b>	343	BCC M425-0000-1A-001-PX0334-100	<b>BCC0319</b>	292
BCC M415-M415-3A-313-PW3534-010	<b>BCC087T</b>	343	BCC M425-0000-1A-001-VX8334-020	<b>BCC0351</b>	292
BCC M415-M415-3A-313-PW3534-015	<b>BCC087U</b>	343	BCC M425-0000-1A-001-VX8334-050	<b>BCC0352</b>	292
BCC M415-M415-3A-313-PW3534-020	<b>BCC087W</b>	343	BCC M425-0000-1A-001-VX8334-100	<b>BCC0353</b>	292
BCC M415-M415-3A-313-PW3534-030	<b>BCC09M2</b>	343	BCC M425-0000-1A-002-PX0334-020	<b>BCC031A</b>	293
BCC M415-M415-3A-313-PW3534-050	<b>BCC09M1</b>	343	BCC M425-0000-1A-002-PX0334-050	<b>BCC031C</b>	293
BCC M415-M415-3A-313-PX0534-003	<b>BCC09FW</b>	312	BCC M425-0000-1A-002-PX0334-100	<b>BCC031E</b>	293
BCC M415-M415-3A-313-PX0534-006	<b>BCC09FY</b>	312	BCC M425-0000-1A-002-VX8334-020	<b>BCC0354</b>	293
BCC M415-M415-3A-313-PX0534-010	<b>BCC09FZ</b>	312	BCC M425-0000-1A-002-VX8334-050	<b>BCC0355</b>	293
BCC M415-M415-3A-313-PX0534-015	<b>BCC09HO</b>	312	BCC M425-0000-1A-002-VX8334-100	<b>BCC0356</b>	293
BCC M415-M415-3A-313-PX0534-020	<b>BCC09H1</b>	312	BCC M425-0000-1A-003-PH0434-020	<b>BCC0AAE</b>	329
BCC M415-M415-3A-313-PX0534-030	<b>BCC09H2</b>	312	BCC M425-0000-1A-003-PH0434-050	<b>BCC0AAF</b>	329
BCC M415-M415-3A-313-PX0534-050	<b>BCC09H3</b>	312	BCC M425-0000-1A-003-PH0434-100	<b>BCC0AAH</b>	329
BCC M415-M415-3A-313-PX0534-100	<b>BCC0AJC</b>	312	BCC M425-0000-1A-003-PW0434-050	<b>BCC0AKE</b>	335
BCC M415-M415-3A-330-VS85N6-006	<b>BCC0E03</b>	81	BCC M425-0000-1A-003-PW0434-100	<b>BCC0AKF</b>	335
BCC M415-M415-3A-330-VS85N6-020	<b>BCC0E04</b>	81	BCC M425-0000-1A-003-PW3434-050	<b>BCC0C22</b>	341
BCC M415-M415-3A-330-VS85N6-050	<b>BCC0E05</b>	81	BCC M425-0000-1A-003-PX0434-020	<b>BCC032Y</b>	296
BCC M415-M415-3A-330-VS85N6-100	<b>BCC0E06</b>	81	BCC M425-0000-1A-003-PX0434-050	<b>BCC032Z</b>	296
BCC M415-M415-3A-330-VS85N6-150	<b>BCC0E07</b>	81	BCC M425-0000-1A-003-PX0434-100	<b>BCC0330</b>	296
BCC M415-M415-M415-U0003-000	<b>BCC089P</b>	38, 58, 71, 91, 123, 190, 325	BCC M425-0000-1A-003-VX8434-020	<b>BCC036N</b>	296
			BCC M425-0000-1A-003-VX8434-050	<b>BCC036P</b>	296
BCC M415-M415-M415-U0016-000	<b>BCC09MU</b>	325	BCC M425-0000-1A-003-VX8434-100	<b>BCC036R</b>	296
BCC M418-0000-1A-044-PX0825-020	<b>BCC06K1</b>	300	BCC M425-0000-1A-004-PW3334-020	<b>BCC09J8</b>	340
BCC M418-0000-1A-044-PX0825-050	<b>BCC06K2</b>	300	BCC M425-0000-1A-004-PW3334-030	<b>BCC08MZ</b>	340
BCC M418-0000-1A-044-PX0825-100	<b>BCC06K3</b>	300	BCC M425-0000-1A-004-PW3334-100	<b>BCC08LE</b>	340
BCC M418-0000-1A-045-PX0825-020	<b>BCC09HC</b>	301	BCC M425-0000-1A-004-PX0334-020	<b>BCC0311</b>	293
BCC M418-0000-1A-045-PX0825-050	<b>BCC09HE</b>	301	BCC M425-0000-1A-004-PX0334-050	<b>BCC0312</b>	293
BCC M418-0000-1A-045-PX0825-100	<b>BCC09HF</b>	301	BCC M425-0000-1A-004-PX0334-100	<b>BCC0313</b>	293
BCC M418-0000-1A-046-PS0825-020	<b>BCC099A</b>	300	BCC M425-0000-1A-004-VX8334-020	<b>BCC034T</b>	293
BCC M418-0000-1A-046-PS0825-050	<b>BCC0995</b>	300	BCC M425-0000-1A-004-VX8334-050	<b>BCC034U</b>	293
BCC M418-0000-1A-046-PS0825-100	<b>BCC0996</b>	300	BCC M425-0000-1A-004-VX8334-100	<b>BCC034W</b>	293
BCC M418-0000-1A-069-PX0825-020	<b>BCC09J3</b>	300	BCC M425-0000-1A-005-PX0334-020	<b>BCC0314</b>	293
BCC M418-0000-1A-069-PX0825-050	<b>BCC09J4</b>	300	BCC M425-0000-1A-005-PX0334-050	<b>BCC0315</b>	293
BCC M418-0000-1A-069-PX0825-100	<b>BCC085Z</b>	300	BCC M425-0000-1A-005-PX0334-100	<b>BCC0316</b>	293
BCC M418-M418-3A-342-PX0825-003	<b>BCC0AC0</b>	315	BCC M425-0000-1A-005-VX8334-020	<b>BCC034Y</b>	293
BCC M418-M418-3A-342-PX0825-006	<b>BCC0AAZ</b>	315	BCC M425-0000-1A-005-VX8334-050	<b>BCC034Z</b>	293
BCC M418-M418-3A-342-PX0825-010	<b>BCC0AC1</b>	315	BCC M425-0000-1A-005-VX8334-100	<b>BCC0350</b>	293
BCC M418-M418-3A-342-PX0825-015	<b>BCC0AC2</b>	315	BCC M425-0000-1A-008-PX0434-020	<b>BCC032N</b>	296
BCC M418-M418-3A-342-PX0825-020	<b>BCC0AC3</b>	315	BCC M425-0000-1A-008-PX0434-050	<b>BCC032P</b>	296
BCC M418-M418-3A-342-PX0825-030	<b>BCC0AC4</b>	315	BCC M425-0000-1A-008-PX0434-100	<b>BCC032R</b>	296
BCC M418-M418-3A-342-PX0825-050	<b>BCC0AC5</b>	315	BCC M425-0000-1A-008-VX8434-020	<b>BCC036F</b>	296
BCC M41C-0000-1A-049-PX0C25-020	<b>BCC06UK</b>	239	BCC M425-0000-1A-008-VX8434-050	<b>BCC036H</b>	296
BCC M41C-0000-1A-049-PX0C25-020	<b>BCC06UK</b>	302	BCC M425-0000-1A-008-VX8434-100	<b>BCC036J</b>	296
BCC M41C-0000-1A-049-PX0C25-050	<b>BCC06UL</b>	239, 302	BCC M425-0000-1A-010-PX0434-020	<b>BCC032T</b>	297
BCC M41C-0000-1A-049-PX0C25-100	<b>BCC06UM</b>	239, 302	BCC M425-0000-1A-010-PX0434-050	<b>BCC032U</b>	297
BCC M41C-0000-1A-049-VX8C25-020	<b>BCC06UP</b>	239, 302	BCC M425-0000-1A-010-PX0434-100	<b>BCC032W</b>	297
BCC M41C-0000-1A-049-VX8C25-050	<b>BCC06UR</b>	239, 302	BCC M425-0000-1A-010-VX8434-020	<b>BCC036K</b>	297
BCC M41C-0000-1A-049-VX8C25-100	<b>BCC06UT</b>	239, 302	BCC M425-0000-1A-010-VX8434-050	<b>BCC036L</b>	297
BCC M41C-0000-2A-049-PX0C25-020	<b>BCC06UU</b>	239, 302	BCC M425-0000-1A-010-VX8434-100	<b>BCC036M</b>	297
BCC M41C-0000-2A-049-PX0C25-050	<b>BCC06UW</b>	239, 302	BCC M425-0000-1A-014-PS0434-020	<b>BCC0331</b>	296
BCC M41C-0000-2A-049-PX0C25-100	<b>BCC06UY</b>	239, 302	BCC M425-0000-1A-014-PS0434-050	<b>BCC0332</b>	296
BCC M41C-0000-2A-049-VX8C25-020	<b>BCC06UZ</b>	239, 302	BCC M425-0000-1A-014-PS0434-100	<b>BCC0333</b>	296
BCC M41C-0000-2A-049-VX8C25-050	<b>BCC06W0</b>	239, 302	BCC M425-0000-1A-014-VS8434-020	<b>BCC036T</b>	296
BCC M41C-0000-2A-049-VX8C25-100	<b>BCC06W1</b>	239, 302	BCC M425-0000-1A-014-VS8434-050	<b>BCC036U</b>	296



# Alphanumeric index

## Sorted by part number

Part number	Ordering code	Page	Part number	Ordering code	Page
BCC M425-0000-1A-014-VS8434-100	<b>BCC036W</b>	296	BCC M425-M314-3F-304-PX0434-003	<b>BCC03RZ</b>	306
BCC M425-0000-1A-017-PX0534-020	<b>BCC09H7</b>	298	BCC M425-M314-3F-304-PX0434-006	<b>BCC03T0</b>	306
BCC M425-0000-1A-017-PX0534-050	<b>BCC08FC</b>	298	BCC M425-M314-3F-304-PX0434-010	<b>BCC03T1</b>	306
BCC M425-0000-1A-017-PX0534-100	<b>BCC08FA</b>	298	BCC M425-M314-3F-304-PX0434-015	<b>BCC03T2</b>	306
BCC M425-0000-1A-034-PX0534-020	<b>BCC08F9</b>	298	BCC M425-M314-3F-304-PX0434-020	<b>BCC03T3</b>	306
BCC M425-0000-1A-034-PX0534-050	<b>BCC08F8</b>	298	BCC M425-M314-3F-304-PX0434-030	<b>BCC03T4</b>	306
BCC M425-0000-1A-034-PX0534-100	<b>BCC08F7</b>	298	BCC M425-M314-3F-304-PX0434-050	<b>BCC03T5</b>	306
BCC M425-0000-1A-036-PS0334-020	<b>BCC031F</b>	292	BCC M425-M314-3F-304-VX8434-003	<b>BCC03U7</b>	306
BCC M425-0000-1A-036-PS0334-050	<b>BCC031H</b>	292	BCC M425-M314-3F-304-VX8434-006	<b>BCC03U8</b>	306
BCC M425-0000-1A-036-PS0334-100	<b>BCC031J</b>	292	BCC M425-M314-3F-304-VX8434-010	<b>BCC03U9</b>	306
BCC M425-0000-1A-036-VS8334-020	<b>BCC0357</b>	292	BCC M425-M314-3F-304-VX8434-015	<b>BCC03UA</b>	306
BCC M425-0000-1A-036-VS8334-050	<b>BCC0358</b>	292	BCC M425-M314-3F-304-VX8434-020	<b>BCC03UC</b>	306
BCC M425-0000-1A-036-VS8334-100	<b>BCC0359</b>	292	BCC M425-M314-3F-304-VX8434-030	<b>BCC03UE</b>	306
BCC M425-0000-1A-037-PS0334-020	<b>BCC031K</b>	293	BCC M425-M314-3F-304-VX8434-050	<b>BCC03UF</b>	306
BCC M425-0000-1A-037-PS0334-050	<b>BCC031L</b>	293	BCC M425-M314-3F-606-PX0434-003	<b>BCC03TF</b>	307
BCC M425-0000-1A-037-PS0334-100	<b>BCC031M</b>	293	BCC M425-M314-3F-606-PX0434-006	<b>BCC03TH</b>	307
BCC M425-0000-1A-037-VS8334-020	<b>BCC035A</b>	293	BCC M425-M314-3F-606-PX0434-010	<b>BCC03TJ</b>	307
BCC M425-0000-1A-037-VS8334-050	<b>BCC035C</b>	293	BCC M425-M314-3F-606-PX0434-015	<b>BCC03TK</b>	307
BCC M425-0000-1A-037-VS8334-100	<b>BCC035E</b>	293	BCC M425-M314-3F-606-PX0434-020	<b>BCC03TL</b>	307
BCC M425-0000-1A-039-PX0534-020	<b>BCC08F6</b>	299	BCC M425-M314-3F-606-PX0434-030	<b>BCC03TM</b>	307
BCC M425-0000-1A-039-PX0534-050	<b>BCC08F5</b>	299	BCC M425-M314-3F-606-PX0434-050	<b>BCC03TN</b>	307
BCC M425-0000-1A-039-PX0534-100	<b>BCC08F4</b>	299	BCC M425-M314-3F-606-VX8434-003	<b>BCC03UR</b>	307
BCC M425-0000-1A-040-PW3534-015	<b>BCC087L</b>	341	BCC M425-M314-3F-606-VX8434-006	<b>BCC03UT</b>	307
BCC M425-0000-1A-040-PW3534-050	<b>BCC087M</b>	341	BCC M425-M314-3F-606-VX8434-010	<b>BCC03UU</b>	307
BCC M425-0000-1A-040-PW3534-075	<b>BCC087N</b>	341	BCC M425-M314-3F-606-VX8434-015	<b>BCC03UW</b>	307
BCC M425-0000-1A-040-PW3534-100	<b>BCC087P</b>	341	BCC M425-M314-3F-606-VX8434-020	<b>BCC03UY</b>	307
BCC M425-0000-1A-040-PX0534-020	<b>BCC08HP</b>	299	BCC M425-M314-3F-606-VX8434-030	<b>BCC03UZ</b>	307
BCC M425-0000-1A-040-PX0534-050	<b>BCC08HR</b>	299	BCC M425-M314-3F-606-VX8434-050	<b>BCC03W0</b>	307
BCC M425-0000-1A-040-PX0534-100	<b>BCC08HT</b>	299	BCC M425-M413-3A-300-PX0334-003	<b>BCC037E</b>	308
BCC M425-0000-1A-099-PW3434-020	<b>BCC0C3Z</b>	341	BCC M425-M413-3A-300-PX0334-006	<b>BCC037F</b>	308
BCC M425-0000-1A-099-PW3434-050	<b>BCC0C41</b>	341	BCC M425-M413-3A-300-PX0334-010	<b>BCC037H</b>	308
BCC M425-0000-1A-099-PW3434-100	<b>BCC0C42</b>	341	BCC M425-M413-3A-300-PX0334-015	<b>BCC037J</b>	308
BCC M425-0000-1A-100-PW3534-020	<b>BCC0C7U</b>	342	BCC M425-M413-3A-300-PX0334-020	<b>BCC037K</b>	308
BCC M425-0000-1A-100-PW3534-050	<b>BCC0C7T</b>	342	BCC M425-M413-3A-300-PX0334-030	<b>BCC037L</b>	308
BCC M425-0000-1A-100-PW3534-100	<b>BCC0C7U</b>	342	BCC M425-M413-3A-300-PX0334-050	<b>BCC037M</b>	308
BCC M425-M313-3F-300-PX0334-003	<b>BCC03MU</b>	304	BCC M425-M413-3A-300-VX8334-003	<b>BCC038P</b>	308
BCC M425-M313-3F-300-PX0334-006	<b>BCC03MW</b>	304	BCC M425-M413-3A-300-VX8334-006	<b>BCC038R</b>	308
BCC M425-M313-3F-300-PX0334-010	<b>BCC03MY</b>	304	BCC M425-M413-3A-300-VX8334-010	<b>BCC038T</b>	308
BCC M425-M313-3F-300-PX0334-015	<b>BCC03MZ</b>	304	BCC M425-M413-3A-300-VX8334-015	<b>BCC038U</b>	308
BCC M425-M313-3F-300-PX0334-020	<b>BCC03NO</b>	304	BCC M425-M413-3A-300-VX8334-020	<b>BCC038W</b>	308
BCC M425-M313-3F-300-PX0334-030	<b>BCC03N1</b>	304	BCC M425-M413-3A-300-VX8334-030	<b>BCC038Y</b>	308
BCC M425-M313-3F-300-PX0334-050	<b>BCC03N2</b>	304	BCC M425-M413-3A-300-VX8334-050	<b>BCC038Z</b>	308
BCC M425-M313-3F-300-VX8334-003	<b>BCC03PC</b>	304	BCC M425-M413-3A-602-PX0334-003	<b>BCC037Z</b>	309
BCC M425-M313-3F-300-VX8334-006	<b>BCC03PE</b>	304	BCC M425-M413-3A-602-PX0334-006	<b>BCC0380</b>	309
BCC M425-M313-3F-300-VX8334-010	<b>BCC03PF</b>	304	BCC M425-M413-3A-602-PX0334-010	<b>BCC0381</b>	309
BCC M425-M313-3F-300-VX8334-015	<b>BCC03PH</b>	304	BCC M425-M413-3A-602-PX0334-015	<b>BCC0382</b>	309
BCC M425-M313-3F-300-VX8334-020	<b>BCC03PJ</b>	304	BCC M425-M413-3A-602-PX0334-020	<b>BCC0383</b>	309
BCC M425-M313-3F-300-VX8334-030	<b>BCC03PK</b>	304	BCC M425-M413-3A-602-PX0334-030	<b>BCC0384</b>	309
BCC M425-M313-3F-300-VX8334-050	<b>BCC03PL</b>	304	BCC M425-M413-3A-602-PX0334-050	<b>BCC0385</b>	309
BCC M425-M313-3F-602-PX0334-003	<b>BCC03NA</b>	305	BCC M425-M413-3A-602-VX8334-003	<b>BCC0397</b>	309
BCC M425-M313-3F-602-PX0334-006	<b>BCC03NC</b>	305	BCC M425-M413-3A-602-VX8334-006	<b>BCC0398</b>	309
BCC M425-M313-3F-602-PX0334-010	<b>BCC03NE</b>	305	BCC M425-M413-3A-602-VX8334-010	<b>BCC0399</b>	309
BCC M425-M313-3F-602-PX0334-015	<b>BCC03NF</b>	305	BCC M425-M413-3A-602-VX8334-015	<b>BCC039A</b>	309
BCC M425-M313-3F-602-PX0334-020	<b>BCC03NH</b>	305	BCC M425-M413-3A-602-VX8334-020	<b>BCC039C</b>	309
BCC M425-M313-3F-602-PX0334-030	<b>BCC03NJ</b>	305	BCC M425-M413-3A-602-VX8334-030	<b>BCC039E</b>	309
BCC M425-M313-3F-602-PX0334-050	<b>BCC03NK</b>	305	BCC M425-M413-3A-602-VX8334-050	<b>BCC039F</b>	309
BCC M425-M313-3F-602-VX8334-003	<b>BCC03PY</b>	305	BCC M425-M414-3A-304-PW0434-003	<b>BCC0ANP</b>	336
BCC M425-M313-3F-602-VX8334-006	<b>BCC03PZ</b>	305	BCC M425-M414-3A-304-PW0434-006	<b>BCC0ANR</b>	336
BCC M425-M313-3F-602-VX8334-010	<b>BCC03RO</b>	305	BCC M425-M414-3A-304-PW0434-010	<b>BCC0ANT</b>	336
BCC M425-M313-3F-602-VX8334-015	<b>BCC03R1</b>	305	BCC M425-M414-3A-304-PW0434-015	<b>BCC0ANU</b>	336
BCC M425-M313-3F-602-VX8334-020	<b>BCC03R2</b>	305	BCC M425-M414-3A-304-PW0434-020	<b>BCC0ANW</b>	336
BCC M425-M313-3F-602-VX8334-030	<b>BCC03R3</b>	305	BCC M425-M414-3A-304-PW0434-050	<b>BCC0ANZ</b>	336
BCC M425-M313-3F-602-VX8334-050	<b>BCC03R4</b>	305	BCC M425-M414-3A-304-PX0434-003	<b>BCC03A8</b>	311

# Alphanumeric index

## Sorted by part number

Part number	Ordering code	Page	Part number	Ordering code	Page
BCC M425-M414-3A-304-PX0434-006	<b>BCC03A9</b>	311	BCC M425-M415-3A-313-PW0534-020	<b>BCC0AKK</b>	337
BCC M425-M414-3A-304-PX0434-010	<b>BCC03AA</b>	311	BCC M425-M415-3A-313-PW0534-030	<b>BCC0AKL</b>	337
BCC M425-M414-3A-304-PX0434-015	<b>BCC03AC</b>	311	BCC M425-M415-3A-313-PW0534-050	<b>BCC0AKM</b>	337
BCC M425-M414-3A-304-PX0434-020	<b>BCC03AE</b>	311	BCC M425-M415-3A-313-PX0534-003	<b>BCC08H0</b>	313
BCC M425-M414-3A-304-PX0434-030	<b>BCC03AF</b>	311	BCC M425-M415-3A-313-PX0534-006	<b>BCC08H1</b>	313
BCC M425-M414-3A-304-PX0434-050	<b>BCC03AH</b>	311	BCC M425-M415-3A-313-PX0534-010	<b>BCC08H2</b>	313
BCC M425-M414-3A-304-VX8434-003	<b>BCC03E3</b>	311	BCC M425-M415-3A-313-PX0534-015	<b>BCC08H3</b>	313
BCC M425-M414-3A-304-VX8434-006	<b>BCC03E4</b>	311	BCC M425-M415-3A-313-PX0534-020	<b>BCC08H4</b>	313
BCC M425-M414-3A-304-VX8434-010	<b>BCC03E5</b>	311	BCC M425-M415-3A-313-PX0534-030	<b>BCC08H5</b>	313
BCC M425-M414-3A-304-VX8434-015	<b>BCC03E6</b>	311	BCC M425-M415-3A-313-PX0534-050	<b>BCC08H6</b>	313
BCC M425-M414-3A-304-VX8434-020	<b>BCC03E7</b>	311	BCC M425-M415-3A-660-PX0534-003	<b>BCC09FA</b>	313
BCC M425-M414-3A-304-VX8434-030	<b>BCC03E8</b>	311	BCC M425-M415-3A-660-PX0534-006	<b>BCC09FC</b>	313
BCC M425-M414-3A-304-VX8434-050	<b>BCC03E9</b>	311	BCC M425-M415-3A-660-PX0534-010	<b>BCC09FE</b>	313
BCC M425-M414-3A-606-PX0434-003	<b>BCC03AT</b>	311	BCC M425-M415-3A-660-PX0534-015	<b>BCC09FH</b>	313
BCC M425-M414-3A-606-PX0434-006	<b>BCC03AU</b>	311	BCC M425-M415-3A-660-PX0534-020	<b>BCC09FF</b>	313
BCC M425-M414-3A-606-PX0434-010	<b>BCC03AW</b>	311	BCC M425-M415-3A-660-PX0534-030	<b>BCC09FJ</b>	313
BCC M425-M414-3A-606-PX0434-015	<b>BCC03AY</b>	311	BCC M425-M415-3A-660-PX0534-050	<b>BCC09FK</b>	313
BCC M425-M414-3A-606-PX0434-020	<b>BCC03AZ</b>	311	BCC M425-M415-3A-661-PW0534-006	<b>BCC0C0N</b>	337
BCC M425-M414-3A-606-PX0434-030	<b>BCC03C0</b>	311	BCC M425-M415-3A-661-PW0534-010	<b>BCC0C0P</b>	337
BCC M425-M414-3A-606-PX0434-050	<b>BCC03C1</b>	311	BCC M425-M415-3A-661-PW0534-015	<b>BCC0C0R</b>	337
BCC M425-M414-3A-606-VX8434-003	<b>BCC03EL</b>	311	BCC M425-M415-3A-661-PW0534-020	<b>BCC0C0T</b>	337
BCC M425-M414-3A-606-VX8434-006	<b>BCC03EM</b>	311	BCC M425-M415-3A-661-PW0534-030	<b>BCC0C0U</b>	337
BCC M425-M414-3A-606-VX8434-010	<b>BCC03EN</b>	311	BCC M425-M415-3A-661-PW0534-050	<b>BCC0C0W</b>	337
BCC M425-M414-3A-606-VX8434-015	<b>BCC03EP</b>	311	BCC M425-M415-3A-661-PX0534-003	<b>BCC09F9</b>	314
BCC M425-M414-3A-606-VX8434-020	<b>BCC03ER</b>	311	BCC M425-M415-3A-661-PX0534-006	<b>BCC09F8</b>	314
BCC M425-M414-3A-606-VX8434-030	<b>BCC03ET</b>	311	BCC M425-M415-3A-661-PX0534-010	<b>BCC09F7</b>	314
BCC M425-M414-3A-606-VX8434-050	<b>BCC03EU</b>	311	BCC M425-M415-3A-661-PX0534-015	<b>BCC09F3</b>	314
BCC M425-M414-3A-650-PW0434-003	<b>BCC0ANE</b>	336	BCC M425-M415-3A-661-PX0534-020	<b>BCC09F4</b>	314
BCC M425-M414-3A-650-PW0434-006	<b>BCC0ANF</b>	336	BCC M425-M415-3A-661-PX0534-030	<b>BCC09F5</b>	314
BCC M425-M414-3A-650-PW0434-010	<b>BCC0ANH</b>	336	BCC M425-M415-3A-661-PX0534-050	<b>BCC09F6</b>	314
BCC M425-M414-3A-650-PW0434-015	<b>BCC0ANJ</b>	336	BCC M425-M415-3A-692-PW3534-003	<b>BCC0C4T</b>	343
BCC M425-M414-3A-650-PW0434-020	<b>BCC0ANK</b>	336	BCC M425-M415-3A-692-PW3534-006	<b>BCC0C4U</b>	343
BCC M425-M414-3A-650-PW0434-050	<b>BCC0ANM</b>	336	BCC M425-M415-3A-692-PW3534-010	<b>BCC0C4W</b>	343
BCC M425-M414-3A-650-PX0434-003	<b>BCC03C2</b>	311	BCC M425-M415-3A-692-PW3534-015	<b>BCC0C4Y</b>	343
BCC M425-M414-3A-650-PX0434-006	<b>BCC03C3</b>	311	BCC M425-M415-3A-692-PW3534-020	<b>BCC0C4Z</b>	343
BCC M425-M414-3A-650-PX0434-010	<b>BCC03C4</b>	311	BCC M425-M415-3A-692-PW3534-030	<b>BCC0C50</b>	343
BCC M425-M414-3A-650-PX0434-015	<b>BCC03C5</b>	311	BCC M425-M415-3A-692-PW3534-050	<b>BCC0C51</b>	343
BCC M425-M414-3A-650-PX0434-020	<b>BCC03C6</b>	311	BCC M425-M415-3A-692-PX0534-003	<b>BCC0C4J</b>	314
BCC M425-M414-3A-650-PX0434-030	<b>BCC03C7</b>	311	BCC M425-M415-3A-692-PX0534-006	<b>BCC0C4H</b>	314
BCC M425-M414-3A-650-PX0434-050	<b>BCC03C8</b>	311	BCC M425-M415-3A-692-PX0534-010	<b>BCC0C4F</b>	314
BCC M425-M414-3A-650-VX8434-003	<b>BCC03EW</b>	311	BCC M425-M415-3A-692-PX0534-015	<b>BCC0C4E</b>	314
BCC M425-M414-3A-650-VX8434-006	<b>BCC03Y4</b>	311	BCC M425-M415-3A-692-PX0534-020	<b>BCC0C4C</b>	314
BCC M425-M414-3A-650-VX8434-010	<b>BCC03EZ</b>	311	BCC M425-M415-3A-692-PX0534-030	<b>BCC0C4A</b>	314
BCC M425-M414-3A-650-VX8434-015	<b>BCC03F0</b>	311	BCC M425-M415-3A-692-PX0534-050	<b>BCC0C49</b>	314
BCC M425-M414-3A-650-VX8434-020	<b>BCC03F1</b>	311	BCC M428-0000-1A-044-PX0825-020	<b>BCC06K4</b>	301
BCC M425-M414-3A-650-VX8434-030	<b>BCC03F2</b>	311	BCC M428-0000-1A-044-PX0825-050	<b>BCC06K5</b>	301
BCC M425-M414-3A-650-VX8434-050	<b>BCC03F3</b>	311	BCC M428-0000-1A-044-PX0825-100	<b>BCC06K6</b>	301
BCC M425-M414-3A-691-PW3434-003	<b>BCC0C4K</b>	343	BCC M428-0000-1A-045-PX0825-020	<b>BCC09H8</b>	301
BCC M425-M414-3A-691-PW3434-006	<b>BCC0C52</b>	343	BCC M428-0000-1A-045-PX0825-050	<b>BCC09H9</b>	301
BCC M425-M414-3A-691-PW3434-010	<b>BCC0C4L</b>	343	BCC M428-0000-1A-045-PX0825-100	<b>BCC09HA</b>	301
BCC M425-M414-3A-691-PW3434-015	<b>BCC0C4M</b>	343	BCC M428-0000-1A-046-PS0825-020	<b>BCC0997</b>	301
BCC M425-M414-3A-691-PW3434-020	<b>BCC0C4N</b>	343	BCC M428-0000-1A-046-PS0825-050	<b>BCC0998</b>	301
BCC M425-M414-3A-691-PW3434-030	<b>BCC0C4P</b>	343	BCC M428-0000-1A-046-PS0825-100	<b>BCC0999</b>	301
BCC M425-M414-3A-691-PW3434-050	<b>BCC0C4R</b>	343	BCC M434-0000-2A-000-41X475-000	<b>BCC06M4</b>	317
BCC M425-M415-3A-312-PX0534-003	<b>BCC08H8</b>	313	BCC M434-0000-2A-000-43X434-000	<b>BCC08C0</b>	318
BCC M425-M415-3A-312-PX0534-006	<b>BCC08H9</b>	313	BCC M434-0000-2A-000-51X475-000	<b>BCC06F7</b>	69, 317
BCC M425-M415-3A-312-PX0534-010	<b>BCC08HA</b>	313	BCC M434-0000-2A-000-55X450-000	<b>BCC06Y5</b>	69, 317
BCC M425-M415-3A-312-PX0534-015	<b>BCC08HC</b>	313	BCC M435-0000-1A-000-41X475-000	<b>BCC06Z9</b>	316
BCC M425-M415-3A-312-PX0534-020	<b>BCC08HE</b>	313	BCC M435-0000-1A-000-43X434-000	<b>BCC06ZY</b>	318
BCC M425-M415-3A-312-PX0534-030	<b>BCC08HF</b>	313	BCC M435-0000-1A-000-51X475-000	<b>BCC06F6</b>	69, 316
BCC M425-M415-3A-312-PX0534-050	<b>BCC08HH</b>	313	BCC M435-0000-1A-000-51X575-000	<b>BCC06W9</b>	317
BCC M425-M415-3A-313-PW0534-006	<b>BCC0AKH</b>	337	BCC M435-0000-1A-000-55X450-000	<b>BCC06Y6</b>	69, 316
BCC M425-M415-3A-313-PW0534-010	<b>BCC0AKJ</b>	337	BCC M435-0000-1A-000-A1X575-000	<b>BCC09JP</b>	320



# Alphanumeric index

## Sorted by part number

Part number	Ordering code	Page	Part number	Ordering code	Page
BCC M435-0000-2A-000-41X575-000	<b>BCC06YA</b>	318	BCC S425-0000-1A-004-PX0334-020	<b>BCC08CM</b>	330
BCC M435-0000-2A-000-51X575-000	<b>BCC06EY</b>	318	BCC S425-0000-1A-004-PX0334-030	<b>BCC08CN</b>	330
BCC M435-0000-2A-000-A1X575-000	<b>BCC09JW</b>	320	BCC S425-0000-1A-004-PX0334-050	<b>BCC08CP</b>	330
BCC M435-000-1A-000-41X575-000	<b>BCC06ZF</b>	317	BCC S425-0000-1A-004-PX0334-100	<b>BCC08CR</b>	330
BCC M444-0000-2A-000-41X475-000	<b>BCC06ZC</b>	317	BCC S425-0000-1A-004-PX0334-150	<b>BCC06UE</b>	330
BCC M444-0000-2A-000-51X475-000	<b>BCC06ZE</b>	317	BCC S425-0000-1A-004-PX0334-200	<b>BCC06UF</b>	330
BCC M445-0000-1A-000-41X475-000	<b>BCC06ZA</b>	316	BCC S425-0000-1A-004-PX0334-250	<b>BCC06UH</b>	330
BCC M445-0000-1A-000-51X475-000	<b>BCC06Y8</b>	316	BCC S425-0000-1A-004-PX0334-400	<b>BCC06UJ</b>	330
BCC M445-0000-1A-000-51X575-000	<b>BCC06ZJ</b>	317	BCC S425-0000-1A-004-VX8334-050	<b>BCC0A2L</b>	330
BCC M445-0000-2A-000-51X575-000	<b>BCC06ZL</b>	318	BCC S425-0000-1A-004-VX8334-100	<b>BCC0A2M</b>	330
BCC M445-000-1A-000-41X575-000	<b>BCC06ZH</b>	317	BCC S425-0000-1A-004-VX8334-150	<b>BCC06U9</b>	330
BCC M445-000-2A-000-41X575-000	<b>BCC06ZK</b>	318	BCC S425-0000-1A-004-VX8334-200	<b>BCC06UA</b>	330
BCC M452-0000-2B-RM080-002	<b>BCC0E40</b>	32	BCC S425-0000-1A-004-VX8334-250	<b>BCC06UC</b>	330
BCC M454-0000-2A-RM020-005	<b>BCC099A</b>	322	BCC S425-0000-1A-008-PX0434-050	<b>BCC08CU</b>	331
BCC M454-0000-2A-RM020-020	<b>BCC0E53</b>	322	BCC S425-0000-1A-008-PX0434-100	<b>BCC0A2K</b>	331
BCC M454-M454-5D-RM002-000	<b>BCC06YP</b>	51, 111	BCC S425-0000-1A-008-VX0434-050	<b>BCC0CTE</b>	331
BCC M455-0000-1A-RM014-005	<b>BCC09JZ</b>	323	BCC S425-0000-1A-008-VX0434-100	<b>BCC0CTC</b>	331
BCC M455-0000-1A-RM014-020	<b>BCC0E54</b>	323	BCC S425-0000-1A-008-VX0434-150	<b>BCC0CTA</b>	331
BCC M455-0000-1A-RM020-005	<b>BCC099C</b>	322	BCC S425-0000-1A-008-VX0434-200	<b>BCC0CT9</b>	331
BCC M455-0000-1A-RM020-020	<b>BCC0CAE</b>	322	BCC S425-0000-1A-008-VX0434-250	<b>BCC0CT8</b>	331
BCC M455-0000-1B-RM080-002	<b>BCC0E3Z</b>	32	BCC S445-0000-1A-000-51X475-000-C024	<b>BCC0CAA</b>	345
BCC M455-0000-2A-RM014-005	<b>BCC09K0</b>	323	BCC VA04-0000-10-053-PX0350-020	<b>BCC04W0</b>	348
BCC M455-0000-2A-RM014-020	<b>BCC0E5F</b>	323	BCC VA04-0000-10-053-PX0350-050	<b>BCC04W1</b>	348
BCC M458-0000-1A-RM015-005	<b>BCC0E55</b>	323	BCC VA04-0000-10-053-PX0350-100	<b>BCC04W2</b>	348
BCC M458-0000-1A-RM015-020	<b>BCC0E56</b>	323	BCC VA04-0000-10-053-VX8350-020	<b>BCC04W3</b>	348
BCC M458-0000-2A-RM015-005	<b>BCC0E57</b>	323	BCC VA04-0000-10-053-VX8350-050	<b>BCC04W4</b>	348
BCC M458-0000-2A-RM015-020	<b>BCC0E58</b>	323	BCC VA04-0000-10-053-VX8350-100	<b>BCC04W5</b>	348
BCC M45C-0000-1A-RM081-005	<b>BCC0E59</b>	324	BCC VA04-0000-10-054-PX0350-020	<b>BCC04W6</b>	348
BCC M45C-0000-1A-RM081-020	<b>BCC0E5A</b>	324	BCC VA04-0000-10-054-PX0350-050	<b>BCC04W7</b>	348
BCC M45C-0000-2A-RM081-005	<b>BCC0E5C</b>	324	BCC VA04-0000-10-054-PX0350-100	<b>BCC04W8</b>	348
BCC M45C-0000-2A-RM081-020	<b>BCC0E5E</b>	324	BCC VA04-0000-10-054-VX8350-020	<b>BCC04W9</b>	348
BCC M474-0000-1D-000-51X475-000	<b>BCC03Y1</b>	55, 113	BCC VA04-0000-10-054-VX8350-050	<b>BCC04WA</b>	348
BCC M474-0000-2D-000-51X475-000	<b>BCC03WZ</b>	54, 112	BCC VA04-0000-10-054-VX8350-100	<b>BCC04WC</b>	348
BCC M475-0000-1B-000-01X575-000	<b>BCC0715</b>	35	BCC VA04-M413-3E-664-PX0350-003	<b>BCC04WF</b>	349
BCC M475-0000-2B-000-01X575-000	<b>BCC0714</b>	35	BCC VA04-M413-3E-664-PX0350-006	<b>BCC04WH</b>	349
BCC M478-0000-1A-000-43X834-000	<b>BCC04MC</b>	321	BCC VA04-M413-3E-664-PX0350-010	<b>BCC0502</b>	349
BCC M484-0000-1D-000-51X475-000	<b>BCC03Y2</b>	55, 113	BCC VA04-M413-3E-664-PX0350-015	<b>BCC04WJ</b>	349
BCC M484-0000-2D-000-51X475-000	<b>BCC03Y0</b>	54, 112	BCC VA04-M413-3E-664-PX0350-020	<b>BCC04WK</b>	349
BCC M485-0000-1B-000-01X575-000	<b>BCC0717</b>	35	BCC VA04-M413-3E-664-PX0350-030	<b>BCC04WL</b>	349
BCC M485-0000-2B-000-01X575-000	<b>BCC0716</b>	35	BCC VA04-M413-3E-664-PX0350-050	<b>BCC04WM</b>	349
BCC M488-0000-1A-000-43X834-000	<b>BCC04ME</b>	321	BCC VB03-0000-10-055-PX0350-020	<b>BCC03YC</b>	350
BCC PA04-0000-10-070-PX0550-020	<b>BCC071A</b>	356	BCC VB03-0000-10-055-PX0350-050	<b>BCC03YE</b>	350
BCC PA04-0000-10-070-PX0550-050	<b>BCC071C</b>	356	BCC VB03-0000-10-055-PX0350-100	<b>BCC03YF</b>	350
BCC PA04-0000-10-070-PX0550-100	<b>BCC071E</b>	356	BCC VB03-0000-10-055-VX8350-020	<b>BCC03ZZ</b>	350
BCC PA24-0000-10-070-PX0550-020	<b>BCC071F</b>	356	BCC VB03-0000-10-055-VX8350-050	<b>BCC0400</b>	350
BCC PA24-0000-10-070-PX0550-050	<b>BCC071H</b>	356	BCC VB03-0000-10-055-VX8350-100	<b>BCC0401</b>	350
BCC PA24-0000-10-070-PX0550-100	<b>BCC071J</b>	356	BCC VB03-M413-3E-666-PX0350-003	<b>BCC064E</b>	351
BCC S323-0000-10-004-PX0334-020	<b>BCC08CZ</b>	330	BCC VB03-M413-3E-666-PX0350-006	<b>BCC064F</b>	351
BCC S323-0000-10-004-PX0334-030	<b>BCC0A2F</b>	330	BCC VB03-M413-3E-666-PX0350-010	<b>BCC064H</b>	351
BCC S323-0000-10-004-PX0334-050	<b>BCC08E0</b>	330	BCC VB03-M413-3E-666-PX0350-015	<b>BCC064J</b>	351
BCC S323-0000-10-004-PX0334-100	<b>BCC0A2H</b>	330	BCC VB03-M413-3E-666-PX0350-020	<b>BCC064K</b>	351
BCC S415-0000-1A-003-VX8434-100	<b>BCC06M7</b>	331	BCC VB03-M413-3E-666-PX0350-030	<b>BCC064L</b>	351
BCC S415-0000-1A-003-VX8434-150	<b>BCC06M8</b>	331	BCC VB03-M413-3E-666-PX0350-050	<b>BCC064M</b>	351
BCC S415-0000-1A-003-VX8434-200	<b>BCC06M9</b>	331	BCC VB23-0000-10-055-PX0350-020	<b>BCC03YH</b>	350
BCC S415-0000-1A-003-VX8434-250	<b>BCC06MA</b>	331	BCC VB23-0000-10-055-PX0350-050	<b>BCC03YJ</b>	350
BCC S415-0000-1A-003-VX8434-300	<b>BCC06MC</b>	330	BCC VB23-0000-10-055-PX0350-100	<b>BCC03YK</b>	350
BCC S415-0000-1A-003-VX8434-350	<b>BCC06ME</b>	330	BCC VB23-0000-10-055-VX8350-020	<b>BCC0402</b>	350
BCC S425-0000-1A-003-VX8434-100	<b>BCC06MF</b>	331	BCC VB23-0000-10-055-VX8350-050	<b>BCC0403</b>	350
BCC S425-0000-1A-003-VX8434-150	<b>BCC06MH</b>	331	BCC VB23-0000-10-055-VX8350-100	<b>BCC0404</b>	350
BCC S425-0000-1A-003-VX8434-200	<b>BCC06MJ</b>	331	BCC VB23-M413-3E-666-PX0350-003	<b>BCC064N</b>	351
BCC S425-0000-1A-003-VX8434-250	<b>BCC06MK</b>	331	BCC VB23-M413-3E-666-PX0350-006	<b>BCC064P</b>	351
BCC S425-0000-1A-003-VX8434-300	<b>BCC06ML</b>	330	BCC VB23-M413-3E-666-PX0350-010	<b>BCC064R</b>	351
BCC S425-0000-1A-003-VX8434-350	<b>BCC06MM</b>	330	BCC VB23-M413-3E-666-PX0350-015	<b>BCC064T</b>	351

# Alphanumeric index

## Sorted by part number

Part number	Ordering code	Page
BCC VB23-M413-3E-666-PX0350-020	<b>BCC064U</b>	351
BCC VB23-M413-3E-666-PX0350-030	<b>BCC064W</b>	351
BCC VB23-M413-3E-666-PX0350-050	<b>BCC064Y</b>	351
BCC VB43-0000-10-055-PX0350-020	<b>BCC03YL</b>	352
BCC VB43-0000-10-055-PX0350-050	<b>BCC03YM</b>	352
BCC VB43-0000-10-055-PX0350-100	<b>BCC03YN</b>	352
BCC VB43-0000-10-055-VX8350-020	<b>BCC0405</b>	352
BCC VB43-0000-10-055-VX8350-050	<b>BCC0406</b>	352
BCC VB43-0000-10-055-VX8350-100	<b>BCC0407</b>	352
BCC VB43-M413-3E-666-PX0350-003	<b>BCC064Z</b>	353
BCC VB43-M413-3E-666-PX0350-006	<b>BCC0650</b>	353
BCC VB43-M413-3E-666-PX0350-010	<b>BCC0651</b>	353
BCC VB43-M413-3E-666-PX0350-015	<b>BCC0652</b>	353
BCC VB43-M413-3E-666-PX0350-020	<b>BCC0653</b>	353
BCC VB43-M413-3E-666-PX0350-030	<b>BCC0654</b>	353
BCC VB43-M413-3E-666-PX0350-050	<b>BCC0655</b>	353
BCC VB63-0000-10-055-PX0350-020	<b>BCC03YP</b>	352
BCC VB63-0000-10-055-PX0350-050	<b>BCC03YR</b>	352
BCC VB63-0000-10-055-PX0350-100	<b>BCC03YT</b>	352
BCC VB63-0000-10-055-VX8350-020	<b>BCC0408</b>	352
BCC VB63-0000-10-055-VX8350-050	<b>BCC0409</b>	352
BCC VB63-0000-10-055-VX8350-100	<b>BCC040A</b>	352
BCC VB63-M413-3E-666-PX0350-003	<b>BCC0656</b>	353
BCC VB63-M413-3E-666-PX0350-006	<b>BCC0657</b>	353
BCC VB63-M413-3E-666-PX0350-010	<b>BCC0658</b>	353
BCC VB63-M413-3E-666-PX0350-015	<b>BCC0659</b>	353
BCC VB63-M413-3E-666-PX0350-020	<b>BCC065A</b>	353
BCC VB63-M413-3E-666-PX0350-030	<b>BCC065C</b>	353
BCC VB63-M413-3E-666-PX0350-050	<b>BCC065E</b>	353
BCC VC04-0000-10-053-PX0350-020	<b>BCC04MZ</b>	354
BCC VC04-0000-10-053-PX0350-050	<b>BCC04N0</b>	354
BCC VC04-0000-10-053-PX0350-100	<b>BCC04N1</b>	354
BCC VC04-0000-10-053-VX8350-020	<b>BCC04N2</b>	354
BCC VC04-0000-10-053-VX8350-050	<b>BCC04N3</b>	354
BCC VC04-0000-10-053-VX8350-100	<b>BCC04N4</b>	354
BCC VC04-M413-3E-664-PX0350-003	<b>BCC04NC</b>	354
BCC VC04-M413-3E-664-PX0350-006	<b>BCC04NE</b>	354
BCC VC04-M413-3E-664-PX0350-010	<b>BCC04NF</b>	354
BCC VC04-M413-3E-664-PX0350-015	<b>BCC04NH</b>	354
BCC VC04-M413-3E-664-PX0350-020	<b>BCC04NJ</b>	354
BCC VC04-M413-3E-664-PX0350-030	<b>BCC04NK</b>	354
BCC VC04-M413-3E-664-PX0350-050	<b>BCC04NL</b>	354
BCC VC44-0000-10-053-PX0350-020	<b>BCC04RF</b>	355
BCC VC44-0000-10-053-PX0350-050	<b>BCC04RH</b>	355
BCC VC44-0000-10-053-PX0350-100	<b>BCC04RJ</b>	355
BCC VC44-0000-10-053-VX8350-020	<b>BCC04RK</b>	355
BCC VC44-0000-10-053-VX8350-050	<b>BCC04RL</b>	355
BCC VC44-0000-10-053-VX8350-100	<b>BCC04RM</b>	355
BCC VC44-M413-3E-664-PX0350-003	<b>BCC04RY</b>	355
BCC VC44-M413-3E-664-PX0350-006	<b>BCC04RZ</b>	355
BCC VC44-M413-3E-664-PX0350-010	<b>BCC04T0</b>	355
BCC VC44-M413-3E-664-PX0350-015	<b>BCC04T1</b>	355
BCC VC44-M413-3E-664-PX0350-020	<b>BCC04T2</b>	355
BCC VC44-M413-3E-664-PX0350-030	<b>BCC04T3</b>	355
BCC VC44-M413-3E-664-PX0350-050	<b>BCC04T4</b>	355

<b>BCS</b>		
BCS 20MG10-XPA1Y-8B-03	<b>BCS0001</b>	198

<b>BES</b>		
BES 113-3019-SA1-S4	<b>BES02M5</b>	198
BES 113-356-SA31-S4	<b>BES02M8</b>	198
BES 113-356-SA6-S4	<b>BES02MC</b>	198

Part number	Ordering code	Page
BES M08EH1-PSY25F-S04G-D01	<b>BES03EM</b>	199
BES M08EH-PSY25F-S49G-D01	<b>BES03EP</b>	199
BES M08EI-PSY15B-S04G-D01	<b>BES03EL</b>	199
BES M08EI-PSY15B-S49G-D01	<b>BES03EN</b>	199
BES M12MH-PSY40F-S04G-D01	<b>BES03ET</b>	199
BES M12MI-PSY20B-S04G-D01	<b>BES03ER</b>	199
BES M18MG-PSY80F-S04G-D01	<b>BES03EW</b>	199
BES M18MI-PSY50B-S04G-D01	<b>BES03EU</b>	199
BES M30MF1-PSY15F-S04G-D01	<b>BES03EZ</b>	199
BES M30MI-PSY10B-S04G-D01	<b>BES03EY</b>	199

<b>BFS</b>		
BFS 26K-GI-L04-S92	<b>BFS000F</b>	158

<b>BGL</b>		
BGL 30A-013-S49	<b>BGL003N</b>	200
BGL 30C-007-S4	<b>BGL0035</b>	157
BGL 30C-009-S4	<b>BGL0036</b>	200
BGL 50A-013-S49	<b>BGL003P</b>	200
BGL 50C-007-S4	<b>BGL003F</b>	157
BGL 50C-009-S4	<b>BGL003H</b>	200
BGL 80A-013-S49	<b>BGL003R</b>	200

<b>BIC</b>		
BIC 1B2-P2A30-Q90AQ-GPX0B-050	<b>BIC003C</b>	223
BIC 110-C1A02-M18MN2-BPX03-050	<b>BIC0047</b>	229
BIC 110-I2A50-M30MI3-SM4A4A	<b>BIC000C</b>	235
BIC 110-I2A50-Q40KFU-SM4A4A	<b>BIC005A</b>	237
BIC 110-IAA50-M30MI3-SM4A4A	<b>BIC0053</b>	235
BIC 110-N2A02-M18MI-BPX03-020	<b>BIC002C</b>	214
BIC 110-N2A02-M18TI-BPX03-050	<b>BIC005T</b>	216
BIC 110-N2A02-M30TI-BPX03-030	<b>BIC005N</b>	217
BIC 110-P2001-M12MM1-BPX03-050	<b>BIC002T</b>	212
BIC 110-P2001-M18MI-BPX03-050	<b>BIC002P</b>	212
BIC 110-P2A02-M18MI-BPX03-050	<b>BIC0029</b>	214
BIC 110-P2A02-M30MI-BPX03-050	<b>BIC002E</b>	215
BIC 110-P2A02-M30TI-BPX03-030	<b>BIC005L</b>	217
BIC 110-V1003-M18MN2-BPX03-050	<b>BIC0046</b>	228
BIC 112-N1A02-M18MN2-EPX07-050	<b>BIC0069</b>	218
BIC 112-P2A02-M18MN2-EPX07-050	<b>BIC0015</b>	218
BIC 112-P2A03-M30M02-EPX07-050	<b>BIC001A</b>	218
BIC 112-V1A18-R01K01-C01	<b>BIC0049</b>	227
BIC 113-N1A15-M30MM3-BPX0B-050	<b>BIC006A</b>	221
BIC 113-P2A05-Q80KA-GPX0C-050	<b>BIC001J</b>	219
BIC 113-P2A15-M30MM3-BPX0B-050	<b>BIC0048</b>	221
BIC 113-P2A16-R01K01-C03	<b>BIC003N</b>	225
BIC 113-P2A20-Q40AA-GPX0B-050	<b>BIC0026</b>	220
BIC 113-P2A20-Q40AC-GPX0B-050	<b>BIC0027</b>	220
BIC 113-P2A30-Q90AA-GPX0B-050	<b>BIC0028</b>	221
BIC 113-P2A40-M18MN2-BPX0B-050	<b>BIC0011</b>	213
BIC 113-P2A40-M30M02-BPX0B-050	<b>BIC000W</b>	213
BIC 113-P2A50-M30MI3-SM4ACA	<b>BIC0009</b>	234
BIC 1P0-P2A20-M30ME-SM4A4A	<b>BIC0051</b>	233
BIC 1P0-P2A50-M30MI3-SM4A4A	<b>BIC0007</b>	233
BIC 2B2-P2A30-Q90AQ-GPX0B-050	<b>BIC0039</b>	223
BIC 2I0-D1001-M12ME1-BPX02-050	<b>BIC003W</b>	212
BIC 2I0-D1001-M18ME1-BPX02-050	<b>BIC003Z</b>	212
BIC 2I0-D2A02-M18TI-BPX03-050	<b>BIC005R</b>	216
BIC 2I0-D2A02-M30TI-BPX03-030	<b>BIC005M</b>	217
BIC 2I0-I2A50-M30MI3-SM4A5A	<b>BIC000E</b>	235
BIC 2I0-I2A50-Q40KFU-SM4A5A	<b>BIC005C</b>	237
BIC 2I0-IAA50-M30MI3-SM4A5A	<b>BIC0054</b>	235
BIC 2I0-N2A02-M18ME-BPX03-010	<b>BIC002L</b>	214

# Alphanumeric index

## Sorted by part number

Part number	Ordering code	Page
BIC 210-N2A02-M18TI-BPX03-050	<b>BIC005P</b>	216
BIC 210-P2A02-M18ME-BPX03-020	<b>BIC002K</b>	214
BIC 210-P2A02-M30TI-BPX03-030	<b>BIC005K</b>	217
BIC 210-P2A05-M30MF-BPX03-030	<b>BIC0044</b>	215
BIC 210-R1002-M18MF2-BPX03-050	<b>BIC0041</b>	229
BIC 210-R3002-M18MF2-BPX03-050	<b>BIC004C</b>	229
BIC 210-V1A01-M18MI2-BPX03-050	<b>BIC0043</b>	228
BIC 212-P2A02-M18MF2-EPX07-050	<b>BIC001N</b>	218
BIC 212-P2A03-M30MF2-EPX07-050	<b>BIC001T</b>	218
BIC 212-V1A18-R01K01-SM3A30	<b>BIC004A</b>	227
BIC 213-P2A05-Q80KA-GPX0C-050	<b>BIC001Y</b>	219
BIC 213-P2A15-M30MI2-BPX0B-050	<b>BIC0045</b>	221
BIC 213-P2A16-R01K01-SM3A30	<b>BIC003P</b>	225
BIC 213-P2A20-Q40AA-GPX0B-050*	<b>BIC0021</b>	220
BIC 213-P2A20-Q40AC-GPX0B-050	<b>BIC0022</b>	220
BIC 213-P2A30-Q90AA-GPX0B-050	<b>BIC0023</b>	221
BIC 213-P2A40-M18MF2-BPX09-050	<b>BIC0012</b>	213
BIC 213-P2A40-M30ME2-BPX09-050	<b>BIC000Y</b>	213
BIC 213-P2A50-M30MI3-SM4ACA	<b>BIC000A</b>	234
BIC 2P0-P2A20-M30ME1-SM4A5A	<b>BIC0052</b>	233
BIC 2P0-P2A50-M30MI3-SM4A5A	<b>BIC0008</b>	233
BIC 902-D2-M12ME-EPX02-020	<b>BIC004N</b>	211
BIC 902-D2-M12ME-EPX02-100	<b>BIC004P</b>	211
BIC 902-D2-M12ME-EPX02-150	<b>BIC004R</b>	211
BIC 905-D2-M18ME-EPX02-010	<b>BIC004W</b>	211
BIC 910-D2-M30MF-EPX02-010	<b>BIC0050</b>	211
BIC 915-D2-M08EE-EPX02-010	<b>BIC004M</b>	211

### BIS

BIS L-409-045-001-07-S4	<b>BIS00CZ</b>	164
BIS L-409-045-002-07-S4	<b>BIS00E0</b>	165
BIS L-409-045-003-07-S4	<b>BIS00E1</b>	165
BIS L-409-045-004-07-S4	<b>BIS00E2</b>	165
BIS M-400-045-001-07-S4	<b>BIS00LH</b>	166
BIS M-400-045-002-07-S4	<b>BIS00LJ</b>	166
BIS M-400-072-001-07-S4	<b>BIS0108</b>	167
BIS M-400-072-002-07-S4	<b>BIS0104</b>	168
BIS M-401-045-001-07-S4	<b>BIS00LK</b>	168
BIS M-401-072-001-07-S4	<b>BIS0102</b>	166
BIS M-402-045-002-07-S4	<b>BIS00LW</b>	167
BIS M-402-045-004-07-S4	<b>BIS00M1</b>	167
BIS M-402-072-002-07-S4	<b>BIS0105</b>	168
BIS M-402-072-004-07-S4	<b>BIS0106</b>	167
BIS M-451-045-001-07-S4	<b>BIS00LM</b>	168
BIS M-451-072-001-07-S4	<b>BIS0103</b>	166
BIS V-6102-019-C001	<b>BIS00T3</b>	163
BIS V-6110-063-C002	<b>BIS00U9</b>	163
BIS V-6111-073-C003	<b>BIS010P</b>	163

### BKS

BKS-7/8-CS-00-A	<b>BAM012T</b>	38, 58, 71, 91, 123, 190
BKS-7/8-CS-00-I	<b>BAM012U</b>	38, 58, 71, 91, 123, 190
BKS-B 25-1/GS49-PU-00,3	<b>BCC00HF</b>	268
BKS-B 25-1/GS49-PU-00,6	<b>BCC00HH</b>	268
BKS-B 25-1/GS49-PU-01	<b>BCC00HJ</b>	268
BKS-B 25-1-PU-03	<b>BCC00HE</b>	266
BKS-B 25-3-PU-03	<b>BCC00HK</b>	266
BKS-B 25-3-PU-05	<b>BCC00HL</b>	266
BKS-B 26-1/GS49-PU-01	<b>BCC00HN</b>	268
BKS-B 26-1-PU-03	<b>BCC00HM</b>	267
BKS-B 26-3-PU-03	<b>BCC00HP</b>	267

Part number	Ordering code	Page
BKS-B 26-3-PU-05	<b>BCC00HR</b>	267
BKS-S 76-RT04	<b>BCC02H6</b>	319
BKS-S 77-RT04	<b>BCC02H7</b>	319
BKS-S107-RT14	<b>BCC02H8</b>	319
BKS-S109-RT14	<b>BCC02H9</b>	319
BKS-S111-RT13	<b>BCC02HC</b>	284
BKS-S113-RT13	<b>BCC02HE</b>	284
BKS-S216-RT14	<b>BCC02HF</b>	285
BKS-S218-RT14	<b>BCC02HH</b>	285

### BNI

BNI ACC-L01-000	<b>BAM01AT</b>	39, 59, 70, 90, 122, 191
BNI CCL-104-100-Z001	<b>BNI002F</b>	65
BNI CCL-106-100-Z001	<b>BNI0049</b>	64
BNI CCL-202-100-Z001	<b>BNI002E</b>	65
BNI CCL-302-100-Z001	<b>BNI002A</b>	65
BNI CCL-305-100-Z001	<b>BNI002C</b>	65
BNI CCL-502-100-Z001	<b>BNI0040</b>	64
BNI EIP-104-100-Z016	<b>BNI0014</b>	104
BNI EIP-104-105-Z015	<b>BNI004M</b>	103
BNI EIP-105-100-Z010	<b>BNI0018</b>	104
BNI EIP-202-100-Z016	<b>BNI0015</b>	104
BNI EIP-202-105-Z015	<b>BNI005J</b>	103
BNI EIP-206-100-Z016	<b>BNI0016</b>	104
BNI EIP-302-105-Z015	<b>BNI004F</b>	103
BNI EIP-305-100-Z016	<b>BNI0017</b>	104
BNI EIP-306-100-Z010	<b>BNI0019</b>	104
BNI EIP-307-100-Z014	<b>BNI0044</b>	103
BNI EIP-502-105-Z015	<b>BNI004A</b>	102
BNI EIP-508-105-Z015	<b>BNI006A</b>	102
BNI EIP-950-000-Z009	<b>BNI000F</b>	130
BNI IOL-101-000-K018	<b>BNI000P</b>	140
BNI IOL-101-S01-K018	<b>BNI001W</b>	142
BNI IOL-102-000-K006	<b>BNI0005</b>	150
BNI IOL-102-000-K019	<b>BNI000R</b>	140
BNI IOL-102-S01-K019	<b>BNI001Y</b>	142
BNI IOL-104-000-K006	<b>BNI0006</b>	150
BNI IOL-104-000-K021	<b>BNI0021</b>	141
BNI IOL-104-000-Z012	<b>BNI0032</b>	145
BNI IOL-104-S01-K021	<b>BNI0022</b>	143
BNI IOL-104-S01-Z012	<b>BNI0039</b>	146
BNI IOL-104-S01-Z012-C01	<b>BNI003T</b>	146
BNI IOL-104-S01-Z012-C02	<b>BNI005P</b>	147
BNI IOL-106-000-K006	<b>BNI0074</b>	150
BNI IOL-106-000-Z012	<b>BNI0063</b>	145
BNI IOL-252-000-Z013	<b>BNI0033</b>	149
BNI IOL-252-S01-Z013	<b>BNI003W</b>	149
BNI IOL-256-000-Z013	<b>BNI0034</b>	149
BNI IOL-256-S01-Z013	<b>BNI003Y</b>	149
BNI IOL-302-000-K006	<b>BNI005L</b>	153
BNI IOL-302-000-K006-C01	<b>BNI005U</b>	153
BNI IOL-302-000-Z012	<b>BNI003U</b>	145
BNI IOL-302-000-Z013	<b>BNI0035</b>	145
BNI IOL-302-S01-K006	<b>BNI005T</b>	153
BNI IOL-302-S01-K006-C01	<b>BNI005W</b>	153
BNI IOL-302-S01-Z012	<b>BNI003C</b>	147
BNI IOL-302-S01-Z013	<b>BNI003A</b>	147
BNI IOL-302-S01-Z013-C01	<b>BNI0048</b>	147
BNI IOL-309-000-K024	<b>BNI004K</b>	155
BNI IOL-310-000-K025	<b>BNI004L</b>	155
BNI IOL-530-000-K006	<b>BNI002Z</b>	201
BNI IOL-709-000-K006	<b>BNI0007</b>	151







# Alphanumeric index

## Sorted by ordering code

Ordering code	Part number	Page
<b>BAE</b>		
BAE0001	BAE PS-XA-1W-24-007-001	370
BAE0002	BAE PS-XA-1W-24-100-004	376
BAE0003	BAE PS-XA-1W-24-200-005	377
BAE0004	BAE PS-XA-1W-24-012-002	371
BAE0005	BAE PS-XA-1W-24-025-002	372
BAE0006	BAE PS-XA-1W-24-050-003	375
BAE0007	BAE PS-XA-3Y-24-050-009	378
BAE0008	BAE PS-XA-3Y-24-100-006	379
BAE0009	BAE PS-XA-3Y-24-200-007	379
BAE0036	BAE PS-XA-1W-12-015-001	370
BAE0039	BAE PS-XA-1W-12-025-002	371
BAE003E	BAE PS-XA-1W-12-050-002	373
BAE003H	BAE PS-XA-1W-12-100-003	375
BAE003J	BAE PS-XA-1W-24-038-003	374
BAE003K	BAE PS-XA-1W-48-025-003	374
BAE003L	BAE PS-XA-1W-48-050-004	376
BAE003M	BAE PS-XA-1W-48-100-005	377
BAE003R	BAE PS-XA-3Y-24-400-010	380
BAE00EK	BAE PS-XA-1W-24-050-013	365
BAE00EN	BAE PS-XA-1W-24-038-601	366
BAE00EP	BAE PS-XA-1W-24-038-602	366
BAE00ER	BAE PS-XA-1W-24-038-603	367
BAE00ET	BAE PS-XA-1W-24-080-604	367
BAE00EU	BAE PS-XA-1W-24-100-014	365
BAE00FL	BAE PS-XA-1W-24-080-605	368
BAE00FW	BAE PS-XA-1W-24-038-607	367
BAE00FY	BAE PS-XA-1W-24-080-606	368

<b>BAM</b>		
	BSB ZM01-L01	191
BAM00ZL	BAM TO-CC-001-M3-0.4/8.0	327
BAM00ZM	BAM TO-CC-001-M4-0.6/12.0	327
BAM00ZN	BAM TO-CC-001-A3-1.5/24.0	327
BAM01C1	BAM CS-XA-001-M8-C	191, 259
BAM01C2	BAM CS-XA-002-M12-A	39, 59, 71, 91, 123, 191, 259
BAM012T	BKS-7/8-CS-00-A	38, 58, 71, 90, 122, 190
BAM012U	BKS-7/8-CS-00-I	38, 58, 71, 90, 122, 190
BAM01AT	BNI ACC-L01-000	39, 59, 70, 91, 123, 191
BAM01JO	BAM FK-NI-PBS-01-C	39, 91
BAM01TY	BAM TO-CC-002-M6	327
	BAM IA-CC-002-01	39, 59, 70, 91, 123, 191, 327

<b>BAW</b>		
BAW002F	BAW M18MI-BLC50B-S04G	160
BAW003A	BAW Z01AC-BLD50B-DP03	161

<b>BCC</b>		
BCC00HE	BKS-B 25-1-PU-03	266
BCC00HF	BKS-B 25-1/GS49-PU-00,3	268
BCC00HH	BKS-B 25-1/GS49-PU-00,6	268
BCC00HJ	BKS-B 25-1/GS49-PU-01	268
BCC00HK	BKS-B 25-3-PU-03	266
BCC00HL	BKS-B 25-3-PU-05	266
BCC00HM	BKS-B 26-1-PU-03	267
BCC00HN	BKS-B 26-1/GS49-PU-01	268
BCC00HP	BKS-B 26-3-PU-03	267

Ordering code	Part number	Page
BCC00HR	BKS-B 26-3-PU-05	267
BCC02H6	BKS-S 76-RT04	319
BCC02H7	BKS-S 77-RT04	319
BCC02H8	BKS-S107-RT14	319
BCC02H9	BKS-S109-RT14	319
BCC02HC	BKS-S111-RT13	284
BCC02HE	BKS-S113-RT13	284
BCC02HF	BKS-S216-RT14	285
BCC02HH	BKS-S218-RT14	285
BCC02M2	BCC M313-0000-20-001-PX0334-020	270
BCC02M3	BCC M313-0000-20-001-PX0334-050	270
BCC02M4	BCC M313-0000-20-001-PX0334-100	270
BCC02M8	BCC M313-0000-10-001-PX0334-020	270
BCC02M9	BCC M313-0000-10-001-PX0334-050	270
BCC02MA	BCC M313-0000-10-001-PX0334-100	270
BCC02MH	BCC M323-0000-10-004-PX0334-020	271
BCC02MJ	BCC M323-0000-10-004-PX0334-050	271
BCC02MK	BCC M323-0000-10-004-PX0334-100	271
BCC02ML	BCC M323-0000-10-001-PX0334-020	271
BCC02MM	BCC M323-0000-10-001-PX0334-050	271
BCC02MN	BCC M323-0000-10-001-PX0334-100	271
BCC02MU	BCC M314-0000-20-003-PX0434-020	272
BCC02MW	BCC M314-0000-20-003-PX0434-050	272
BCC02MY	BCC M314-0000-20-003-PX0434-100	272
BCC02N2	BCC M314-0000-10-003-PX0434-020	272
BCC02N3	BCC M314-0000-10-003-PX0434-050	272
BCC02N4	BCC M314-0000-10-003-PX0434-100	272
BCC02N8	BCC M324-0000-10-008-PX0434-020	273
BCC02N9	BCC M324-0000-10-008-PX0434-050	273
BCC02NA	BCC M324-0000-10-008-PX0434-100	273
BCC02NC	BCC M324-0000-10-003-PX0434-020	273
BCC02NE	BCC M324-0000-10-003-PX0434-050	273
BCC02NF	BCC M324-0000-10-003-PX0434-100	273
BCC02NL	BCC M313-0000-20-001-VX8334-020	270
BCC02NM	BCC M313-0000-20-001-VX8334-050	270
BCC02NN	BCC M313-0000-20-001-VX8334-100	270
BCC02NU	BCC M313-0000-10-001-VX8334-020	270
BCC02NW	BCC M313-0000-10-001-VX8334-050	270
BCC02NY	BCC M313-0000-10-001-VX8334-100	270
BCC02P2	BCC M323-0000-10-004-VX8334-020	271
BCC02P3	BCC M323-0000-10-004-VX8334-050	271
BCC02P4	BCC M323-0000-10-004-VX8334-100	271
BCC02P5	BCC M323-0000-10-001-VX8334-020	271
BCC02P6	BCC M323-0000-10-001-VX8334-050	271
BCC02P7	BCC M323-0000-10-001-VX8334-100	271
BCC02PC	BCC M314-0000-20-003-VX8434-020	272
BCC02PE	BCC M314-0000-20-003-VX8434-050	272
BCC02PF	BCC M314-0000-20-003-VX8434-100	272
BCC02PL	BCC M314-0000-10-003-VX8434-020	272
BCC02PM	BCC M314-0000-10-003-VX8434-050	272
BCC02PN	BCC M314-0000-10-003-VX8434-100	272
BCC02PU	BCC M324-0000-10-008-VX8434-020	273
BCC02PW	BCC M324-0000-10-008-VX8434-050	273
BCC02PY	BCC M324-0000-10-008-VX8434-100	273
BCC02PZ	BCC M324-0000-10-003-VX8434-020	273
BCC02R0	BCC M324-0000-10-003-VX8434-050	273
BCC02R1	BCC M324-0000-10-003-VX8434-100	273
BCC02R5	BCC M313-M313-30-300-PX0334-003	274
BCC02R6	BCC M313-M313-30-300-PX0334-006	274
BCC02R7	BCC M313-M313-30-300-PX0334-010	274
BCC02R8	BCC M313-M313-30-300-PX0334-015	274
BCC02R9	BCC M313-M313-30-300-PX0334-020	274
BCC02RA	BCC M313-M313-30-300-PX0334-030	274

# Alphanumeric index

## Sorted by ordering code

Ordering code	Part number	Page
BCC02RC	BCC M313-M313-30-300-PX0334-050	274
BCC02RE	BCC M313-M323-30-300-PX0334-003	275
BCC02RF	BCC M313-M323-30-300-PX0334-006	275
BCC02RH	BCC M313-M323-30-300-PX0334-010	275
BCC02RJ	BCC M313-M323-30-300-PX0334-015	275
BCC02RK	BCC M313-M323-30-300-PX0334-020	275
BCC02RL	BCC M313-M323-30-300-PX0334-030	275
BCC02RM	BCC M313-M323-30-300-PX0334-050	275
BCC02RN	BCC M323-M313-30-602-PX0334-003	275
BCC02RP	BCC M323-M313-30-602-PX0334-006	275
BCC02RR	BCC M323-M313-30-602-PX0334-010	275
BCC02RT	BCC M323-M313-30-602-PX0334-015	275
BCC02RU	BCC M323-M313-30-602-PX0334-020	275
BCC02RW	BCC M323-M313-30-602-PX0334-030	275
BCC02RY	BCC M323-M313-30-602-PX0334-050	275
BCC02RZ	BCC M323-M313-30-300-PX0334-003	275
BCC02T0	BCC M323-M313-30-300-PX0334-006	275
BCC02T1	BCC M323-M313-30-300-PX0334-010	275
BCC02T2	BCC M323-M313-30-300-PX0334-015	275
BCC02T3	BCC M323-M313-30-300-PX0334-020	275
BCC02T4	BCC M323-M313-30-300-PX0334-030	275
BCC02T5	BCC M323-M313-30-300-PX0334-050	275
BCC02TF	BCC M314-M314-30-304-PX0434-003	276
BCC02TH	BCC M314-M314-30-304-PX0434-006	276
BCC02TJ	BCC M314-M314-30-304-PX0434-010	276
BCC02TK	BCC M314-M314-30-304-PX0434-015	276
BCC02TL	BCC M314-M314-30-304-PX0434-020	276
BCC02TM	BCC M314-M314-30-304-PX0434-030	276
BCC02TN	BCC M314-M314-30-304-PX0434-050	276
BCC02TP	BCC M314-M324-30-304-PX0434-003	277
BCC02TR	BCC M314-M324-30-304-PX0434-006	277
BCC02TT	BCC M314-M324-30-304-PX0434-010	277
BCC02TU	BCC M314-M324-30-304-PX0434-015	277
BCC02TW	BCC M314-M324-30-304-PX0434-020	277
BCC02TY	BCC M314-M324-30-304-PX0434-030	277
BCC02TZ	BCC M314-M324-30-304-PX0434-050	277
BCC02U0	BCC M324-M314-30-606-PX0434-003	277
BCC02U1	BCC M324-M314-30-606-PX0434-006	277
BCC02U2	BCC M324-M314-30-606-PX0434-010	277
BCC02U3	BCC M324-M314-30-606-PX0434-015	277
BCC02U4	BCC M324-M314-30-606-PX0434-020	277
BCC02U5	BCC M324-M314-30-606-PX0434-030	277
BCC02U6	BCC M324-M314-30-606-PX0434-050	277
BCC02U7	BCC M324-M314-30-304-PX0434-003	277
BCC02U8	BCC M324-M314-30-304-PX0434-006	277
BCC02U9	BCC M324-M314-30-304-PX0434-010	277
BCC02UA	BCC M324-M314-30-304-PX0434-015	277
BCC02UC	BCC M324-M314-30-304-PX0434-020	277
BCC02UE	BCC M324-M314-30-304-PX0434-030	277
BCC02UF	BCC M324-M314-30-304-PX0434-050	277
BCC02UR	BCC M313-M313-30-300-VX8334-003	274
BCC02UT	BCC M313-M313-30-300-VX8334-006	274
BCC02UU	BCC M313-M313-30-300-VX8334-010	274
BCC02UW	BCC M313-M313-30-300-VX8334-015	274
BCC02UY	BCC M313-M313-30-300-VX8334-020	274
BCC02UZ	BCC M313-M313-30-300-VX8334-030	274
BCC02W0	BCC M313-M313-30-300-VX8334-050	274
BCC02W1	BCC M313-M323-30-300-VX8334-003	275
BCC02W2	BCC M313-M323-30-300-VX8334-006	275
BCC02W3	BCC M313-M323-30-300-VX8334-010	275
BCC02W4	BCC M313-M323-30-300-VX8334-015	275
BCC02W5	BCC M313-M323-30-300-VX8334-020	275
BCC02W6	BCC M313-M323-30-300-VX8334-030	275

Ordering code	Part number	Page
BCC02W7	BCC M313-M323-30-300-VX8334-050	275
BCC02W8	BCC M323-M313-30-602-VX8334-003	275
BCC02W9	BCC M323-M313-30-602-VX8334-006	275
BCC02WA	BCC M323-M313-30-602-VX8334-010	275
BCC02WC	BCC M323-M313-30-602-VX8334-015	275
BCC02WE	BCC M323-M313-30-602-VX8334-020	275
BCC02WF	BCC M323-M313-30-602-VX8334-030	275
BCC02WH	BCC M323-M313-30-602-VX8334-050	275
BCC02WJ	BCC M323-M313-30-300-VX8334-003	275
BCC02WK	BCC M323-M313-30-300-VX8334-006	275
BCC02WL	BCC M323-M313-30-300-VX8334-010	275
BCC02WM	BCC M323-M313-30-300-VX8334-015	275
BCC02WN	BCC M323-M313-30-300-VX8334-020	275
BCC02WP	BCC M323-M313-30-300-VX8334-030	275
BCC02WR	BCC M323-M313-30-300-VX8334-050	275
BCC02Y2	BCC M314-M314-30-304-VX8434-003	276
BCC02Y3	BCC M314-M314-30-304-VX8434-006	276
BCC02Y4	BCC M314-M314-30-304-VX8434-010	276
BCC02Y5	BCC M314-M314-30-304-VX8434-015	276
BCC02Y6	BCC M314-M314-30-304-VX8434-020	276
BCC02Y7	BCC M314-M314-30-304-VX8434-030	276
BCC02Y8	BCC M314-M314-30-304-VX8434-050	276
BCC02Y9	BCC M314-M324-30-304-VX8434-003	277
BCC02YA	BCC M314-M324-30-304-VX8434-006	277
BCC02YC	BCC M314-M324-30-304-VX8434-010	277
BCC02YE	BCC M314-M324-30-304-VX8434-015	277
BCC02YF	BCC M314-M324-30-304-VX8434-020	277
BCC02YH	BCC M314-M324-30-304-VX8434-030	277
BCC02YJ	BCC M314-M324-30-304-VX8434-050	277
BCC02YK	BCC M324-M314-30-606-VX8434-003	277
BCC02YL	BCC M324-M314-30-606-VX8434-006	277
BCC02YM	BCC M324-M314-30-606-VX8434-010	277
BCC02YN	BCC M324-M314-30-606-VX8434-015	277
BCC02YP	BCC M324-M314-30-606-VX8434-020	277
BCC02YR	BCC M324-M314-30-606-VX8434-030	277
BCC02YT	BCC M324-M314-30-606-VX8434-050	277
BCC02YU	BCC M324-M314-30-304-VX8434-003	277
BCC02YW	BCC M324-M314-30-304-VX8434-006	277
BCC02YY	BCC M324-M314-30-304-VX8434-010	277
BCC02YZ	BCC M324-M314-30-304-VX8434-015	277
BCC02Z0	BCC M324-M314-30-304-VX8434-020	277
BCC02Z1	BCC M324-M314-30-304-VX8434-030	277
BCC02Z2	BCC M324-M314-30-304-VX8434-050	277
BCC02ZA	BCC M413-0000-2A-001-PX0334-020	290
BCC02ZC	BCC M413-0000-2A-001-PX0334-050	290
BCC02ZE	BCC M413-0000-2A-001-PX0334-100	290
BCC02ZF	BCC M413-0000-2A-002-PX0334-020	290
BCC02ZH	BCC M413-0000-2A-002-PX0334-050	290
BCC02ZJ	BCC M413-0000-2A-002-PX0334-100	290
BCC02ZK	BCC M413-0000-2A-036-PS0334-020	290
BCC02ZL	BCC M413-0000-2A-036-PS0334-050	290
BCC02ZM	BCC M413-0000-2A-036-PS0334-100	290
BCC02ZN	BCC M413-0000-2A-037-PS0334-020	290
BCC02ZP	BCC M413-0000-2A-037-PS0334-050	290
BCC02ZR	BCC M413-0000-2A-037-PS0334-100	290
BCC030A	BCC M415-0000-1A-004-PX0334-020	291
BCC030C	BCC M415-0000-1A-004-PX0334-050	291
BCC030E	BCC M415-0000-1A-004-PX0334-100	291
BCC030F	BCC M415-0000-1A-005-PX0334-020	292
BCC030H	BCC M415-0000-1A-005-PX0334-050	292
BCC030J	BCC M415-0000-1A-005-PX0334-100	292
BCC030K	BCC M415-0000-1A-001-PX0334-020	291
BCC030L	BCC M415-0000-1A-001-PX0334-050	291

# Alphanumeric index

## Sorted by ordering code

Ordering code	Part number	Page
<b>BCC030M</b>	BCC M415-0000-1A-001-PX0334-100	291
<b>BCC030N</b>	BCC M415-0000-1A-002-PX0334-020	291
<b>BCC030P</b>	BCC M415-0000-1A-002-PX0334-050	291
<b>BCC030R</b>	BCC M415-0000-1A-002-PX0334-100	291
<b>BCC030T</b>	BCC M415-0000-1A-036-PS0334-020	291
<b>BCC030U</b>	BCC M415-0000-1A-036-PS0334-050	291
<b>BCC030W</b>	BCC M415-0000-1A-036-PS0334-100	291
<b>BCC030Y</b>	BCC M415-0000-1A-037-PS0334-020	291
<b>BCC030Z</b>	BCC M415-0000-1A-037-PS0334-050	291
<b>BCC0310</b>	BCC M415-0000-1A-037-PS0334-100	291
<b>BCC0311</b>	BCC M425-0000-1A-004-PX0334-020	293
<b>BCC0312</b>	BCC M425-0000-1A-004-PX0334-050	293
<b>BCC0313</b>	BCC M425-0000-1A-004-PX0334-100	293
<b>BCC0314</b>	BCC M425-0000-1A-005-PX0334-020	293
<b>BCC0315</b>	BCC M425-0000-1A-005-PX0334-050	293
<b>BCC0316</b>	BCC M425-0000-1A-005-PX0334-100	293
<b>BCC0317</b>	BCC M425-0000-1A-001-PX0334-020	292
<b>BCC0318</b>	BCC M425-0000-1A-001-PX0334-050	292
<b>BCC0319</b>	BCC M425-0000-1A-001-PX0334-100	292
<b>BCC031A</b>	BCC M425-0000-1A-002-PX0334-020	293
<b>BCC031C</b>	BCC M425-0000-1A-002-PX0334-050	293
<b>BCC031E</b>	BCC M425-0000-1A-002-PX0334-100	293
<b>BCC031F</b>	BCC M425-0000-1A-036-PS0334-020	292
<b>BCC031H</b>	BCC M425-0000-1A-036-PS0334-050	292
<b>BCC031J</b>	BCC M425-0000-1A-036-PS0334-100	292
<b>BCC031K</b>	BCC M425-0000-1A-037-PS0334-020	293
<b>BCC031L</b>	BCC M425-0000-1A-037-PS0334-050	293
<b>BCC031M</b>	BCC M425-0000-1A-037-PS0334-100	293
<b>BCC031N</b>	BCC M414-0000-2A-003-PX0434-020	294
<b>BCC031P</b>	BCC M414-0000-2A-003-PX0434-050	294
<b>BCC031R</b>	BCC M414-0000-2A-003-PX0434-100	294
<b>BCC031T</b>	BCC M414-0000-2A-014-PS0434-020	294
<b>BCC031U</b>	BCC M414-0000-2A-014-PS0434-050	294
<b>BCC031W</b>	BCC M414-0000-2A-014-PS0434-100	294
<b>BCC0327</b>	BCC M415-0000-1A-008-PX0434-020	295
<b>BCC0328</b>	BCC M415-0000-1A-008-PX0434-050	295
<b>BCC0329</b>	BCC M415-0000-1A-008-PX0434-100	295
<b>BCC032A</b>	BCC M415-0000-1A-010-PX0434-020	295
<b>BCC032C</b>	BCC M415-0000-1A-010-PX0434-050	295
<b>BCC032E</b>	BCC M415-0000-1A-010-PX0434-100	295
<b>BCC032F</b>	BCC M415-0000-1A-003-PX0434-020	295
<b>BCC032H</b>	BCC M415-0000-1A-003-PX0434-050	295
<b>BCC032J</b>	BCC M415-0000-1A-003-PX0434-100	295
<b>BCC032K</b>	BCC M415-0000-1A-014-PS0434-020	295
<b>BCC032L</b>	BCC M415-0000-1A-014-PS0434-050	295
<b>BCC032M</b>	BCC M415-0000-1A-014-PS0434-100	295
<b>BCC032N</b>	BCC M425-0000-1A-008-PX0434-020	296
<b>BCC032P</b>	BCC M425-0000-1A-008-PX0434-050	296
<b>BCC032R</b>	BCC M425-0000-1A-008-PX0434-100	296
<b>BCC032T</b>	BCC M425-0000-1A-010-PX0434-020	297
<b>BCC032U</b>	BCC M425-0000-1A-010-PX0434-050	297
<b>BCC032W</b>	BCC M425-0000-1A-010-PX0434-100	297
<b>BCC032Y</b>	BCC M425-0000-1A-003-PX0434-020	296
<b>BCC032Z</b>	BCC M425-0000-1A-003-PX0434-050	296
<b>BCC0330</b>	BCC M425-0000-1A-003-PX0434-100	296
<b>BCC0331</b>	BCC M425-0000-1A-014-PS0434-020	296
<b>BCC0332</b>	BCC M425-0000-1A-014-PS0434-050	296
<b>BCC0333</b>	BCC M425-0000-1A-014-PS0434-100	296
<b>BCC0334</b>	BCC M413-0000-2A-001-VX8334-020	290
<b>BCC0335</b>	BCC M413-0000-2A-001-VX8334-050	290
<b>BCC0336</b>	BCC M413-0000-2A-001-VX8334-100	290
<b>BCC0337</b>	BCC M413-0000-2A-002-VX8334-020	290
<b>BCC0338</b>	BCC M413-0000-2A-002-VX8334-050	290

Ordering code	Part number	Page
<b>BCC0339</b>	BCC M413-0000-2A-002-VX8334-100	290
<b>BCC033A</b>	BCC M413-0000-2A-036-VS8334-020	290
<b>BCC033C</b>	BCC M413-0000-2A-036-VS8334-050	290
<b>BCC033E</b>	BCC M413-0000-2A-036-VS8334-100	290
<b>BCC033F</b>	BCC M413-0000-2A-037-VS8334-020	290
<b>BCC033H</b>	BCC M413-0000-2A-037-VS8334-050	290
<b>BCC033J</b>	BCC M413-0000-2A-037-VS8334-100	290
<b>BCC0344</b>	BCC M415-0000-1A-004-VX8334-020	291
<b>BCC0345</b>	BCC M415-0000-1A-004-VX8334-050	291
<b>BCC0346</b>	BCC M415-0000-1A-004-VX8334-100	291
<b>BCC0347</b>	BCC M415-0000-1A-005-VX8334-020	292
<b>BCC0348</b>	BCC M415-0000-1A-005-VX8334-050	292
<b>BCC0349</b>	BCC M415-0000-1A-005-VX8334-100	292
<b>BCC034A</b>	BCC M415-0000-1A-001-VX8334-020	291
<b>BCC034C</b>	BCC M415-0000-1A-001-VX8334-050	291
<b>BCC034E</b>	BCC M415-0000-1A-001-VX8334-100	291
<b>BCC034F</b>	BCC M415-0000-1A-002-VX8334-020	291
<b>BCC034H</b>	BCC M415-0000-1A-002-VX8334-050	291
<b>BCC034J</b>	BCC M415-0000-1A-002-VX8334-100	291
<b>BCC034K</b>	BCC M415-0000-1A-036-VS8334-020	291
<b>BCC034L</b>	BCC M415-0000-1A-036-VS8334-050	291
<b>BCC034M</b>	BCC M415-0000-1A-036-VS8334-100	291
<b>BCC034N</b>	BCC M415-0000-1A-037-VS8334-020	291
<b>BCC034P</b>	BCC M415-0000-1A-037-VS8334-050	291
<b>BCC034R</b>	BCC M415-0000-1A-037-VS8334-100	291
<b>BCC034T</b>	BCC M425-0000-1A-004-VX8334-020	293
<b>BCC034U</b>	BCC M425-0000-1A-004-VX8334-050	293
<b>BCC034W</b>	BCC M425-0000-1A-004-VX8334-100	293
<b>BCC034Y</b>	BCC M425-0000-1A-005-VX8334-020	293
<b>BCC034Z</b>	BCC M425-0000-1A-005-VX8334-050	293
<b>BCC0350</b>	BCC M425-0000-1A-005-VX8334-100	293
<b>BCC0351</b>	BCC M425-0000-1A-001-VX8334-020	292
<b>BCC0352</b>	BCC M425-0000-1A-001-VX8334-050	292
<b>BCC0353</b>	BCC M425-0000-1A-001-VX8334-100	292
<b>BCC0354</b>	BCC M425-0000-1A-002-VX8334-020	293
<b>BCC0355</b>	BCC M425-0000-1A-002-VX8334-050	293
<b>BCC0356</b>	BCC M425-0000-1A-002-VX8334-100	293
<b>BCC0357</b>	BCC M425-0000-1A-036-VS8334-020	292
<b>BCC0358</b>	BCC M425-0000-1A-036-VS8334-050	292
<b>BCC0359</b>	BCC M425-0000-1A-036-VS8334-100	292
<b>BCC035A</b>	BCC M425-0000-1A-037-VS8334-020	293
<b>BCC035C</b>	BCC M425-0000-1A-037-VS8334-050	293
<b>BCC035E</b>	BCC M425-0000-1A-037-VS8334-100	293
<b>BCC035F</b>	BCC M414-0000-2A-003-VX8434-020	294
<b>BCC035H</b>	BCC M414-0000-2A-003-VX8434-050	294
<b>BCC035J</b>	BCC M414-0000-2A-003-VX8434-100	294
<b>BCC035K</b>	BCC M414-0000-2A-014-VS8434-020	294
<b>BCC035L</b>	BCC M414-0000-2A-014-VS8434-050	294
<b>BCC035M</b>	BCC M414-0000-2A-014-VS8434-100	294
<b>BCC0361</b>	BCC M415-0000-1A-008-VX8434-020	295
<b>BCC0362</b>	BCC M415-0000-1A-008-VX8434-050	295
<b>BCC0363</b>	BCC M415-0000-1A-008-VX8434-100	295
<b>BCC0364</b>	BCC M415-0000-1A-010-VX8434-020	295
<b>BCC0365</b>	BCC M415-0000-1A-010-VX8434-050	295
<b>BCC0366</b>	BCC M415-0000-1A-010-VX8434-100	295
<b>BCC0367</b>	BCC M415-0000-1A-003-VX8434-020	295
<b>BCC0368</b>	BCC M415-0000-1A-003-VX8434-050	295
<b>BCC0369</b>	BCC M415-0000-1A-003-VX8434-100	295
<b>BCC036A</b>	BCC M415-0000-1A-014-VS8434-020	295
<b>BCC036C</b>	BCC M415-0000-1A-014-VS8434-050	295
<b>BCC036E</b>	BCC M415-0000-1A-014-VS8434-100	295
<b>BCC036F</b>	BCC M425-0000-1A-008-VX8434-020	296
<b>BCC036H</b>	BCC M425-0000-1A-008-VX8434-050	296



# Alphanumeric index

## Sorted by ordering code

Ordering code	Part number	Page
BCC036J	BCC M425-0000-1A-008-VX8434-100	296
BCC036K	BCC M425-0000-1A-010-VX8434-020	297
BCC036L	BCC M425-0000-1A-010-VX8434-050	297
BCC036M	BCC M425-0000-1A-010-VX8434-100	297
BCC036N	BCC M425-0000-1A-003-VX8434-020	296
BCC036P	BCC M425-0000-1A-003-VX8434-050	296
BCC036R	BCC M425-0000-1A-003-VX8434-100	296
BCC036T	BCC M425-0000-1A-014-VS8434-020	296
BCC036U	BCC M425-0000-1A-014-VS8434-050	296
BCC036W	BCC M425-0000-1A-014-VS8434-100	296
BCC036Y	BCC M415-M413-3A-300-PX0334-003	308
BCC036Z	BCC M415-M413-3A-300-PX0334-006	308
BCC0370	BCC M415-M413-3A-300-PX0334-010	308
BCC0371	BCC M415-M413-3A-300-PX0334-015	308
BCC0372	BCC M415-M413-3A-300-PX0334-020	308
BCC0373	BCC M415-M413-3A-300-PX0334-030	308
BCC0374	BCC M415-M413-3A-300-PX0334-050	308
BCC037E	BCC M425-M413-3A-300-PX0334-003	308
BCC037F	BCC M425-M413-3A-300-PX0334-006	308
BCC037H	BCC M425-M413-3A-300-PX0334-010	308
BCC037J	BCC M425-M413-3A-300-PX0334-015	308
BCC037K	BCC M425-M413-3A-300-PX0334-020	308
BCC037L	BCC M425-M413-3A-300-PX0334-030	308
BCC037M	BCC M425-M413-3A-300-PX0334-050	308
BCC037Z	BCC M425-M413-3A-602-PX0334-003	309
BCC0380	BCC M425-M413-3A-602-PX0334-006	309
BCC0381	BCC M425-M413-3A-602-PX0334-010	309
BCC0382	BCC M425-M413-3A-602-PX0334-015	309
BCC0383	BCC M425-M413-3A-602-PX0334-020	309
BCC0384	BCC M425-M413-3A-602-PX0334-030	309
BCC0385	BCC M425-M413-3A-602-PX0334-050	309
BCC0386	BCC M415-M413-3A-300-VX8334-003	308
BCC0387	BCC M415-M413-3A-300-VX8334-006	308
BCC0388	BCC M415-M413-3A-300-VX8334-010	308
BCC0389	BCC M415-M413-3A-300-VX8334-015	308
BCC038A	BCC M415-M413-3A-300-VX8334-020	308
BCC038C	BCC M415-M413-3A-300-VX8334-030	308
BCC038E	BCC M415-M413-3A-300-VX8334-050	308
BCC038P	BCC M425-M413-3A-300-VX8334-003	308
BCC038R	BCC M425-M413-3A-300-VX8334-006	308
BCC038T	BCC M425-M413-3A-300-VX8334-010	308
BCC038U	BCC M425-M413-3A-300-VX8334-015	308
BCC038W	BCC M425-M413-3A-300-VX8334-020	308
BCC038Y	BCC M425-M413-3A-300-VX8334-030	308
BCC038Z	BCC M425-M413-3A-300-VX8334-050	308
BCC0397	BCC M425-M413-3A-602-VX8334-003	309
BCC0398	BCC M425-M413-3A-602-VX8334-006	309
BCC0399	BCC M425-M413-3A-602-VX8334-010	309
BCC039A	BCC M425-M413-3A-602-VX8334-015	309
BCC039C	BCC M425-M413-3A-602-VX8334-020	309
BCC039E	BCC M425-M413-3A-602-VX8334-030	309
BCC039F	BCC M425-M413-3A-602-VX8334-050	309
BCC039H	BCC M415-M414-3A-304-PX0434-003	310
BCC039J	BCC M415-M414-3A-304-PX0434-006	310
BCC039K	BCC M415-M414-3A-304-PX0434-010	310
BCC039L	BCC M415-M414-3A-304-PX0434-015	310
BCC039M	BCC M415-M414-3A-304-PX0434-020	310
BCC039N	BCC M415-M414-3A-304-PX0434-030	310
BCC039P	BCC M415-M414-3A-304-PX0434-050	310
BCC03A1	BCC M415-M414-3A-606-PX0434-003	310
BCC03A2	BCC M415-M414-3A-606-PX0434-006	310
BCC03A3	BCC M415-M414-3A-606-PX0434-010	310
BCC03A4	BCC M415-M414-3A-606-PX0434-015	310

Ordering code	Part number	Page
BCC03A5	BCC M415-M414-3A-606-PX0434-020	310
BCC03A6	BCC M415-M414-3A-606-PX0434-030	310
BCC03A7	BCC M415-M414-3A-606-PX0434-050	310
BCC03A8	BCC M425-M414-3A-304-PX0434-003	311
BCC03A9	BCC M425-M414-3A-304-PX0434-006	311
BCC03AA	BCC M425-M414-3A-304-PX0434-010	311
BCC03AC	BCC M425-M414-3A-304-PX0434-015	311
BCC03AE	BCC M425-M414-3A-304-PX0434-020	311
BCC03AF	BCC M425-M414-3A-304-PX0434-030	311
BCC03AH	BCC M425-M414-3A-304-PX0434-050	311
BCC03AT	BCC M425-M414-3A-606-PX0434-003	311
BCC03AU	BCC M425-M414-3A-606-PX0434-006	311
BCC03AW	BCC M425-M414-3A-606-PX0434-010	311
BCC03AY	BCC M425-M414-3A-606-PX0434-015	311
BCC03AZ	BCC M425-M414-3A-606-PX0434-020	311
BCC03C0	BCC M425-M414-3A-606-PX0434-030	311
BCC03C1	BCC M425-M414-3A-606-PX0434-050	311
BCC03C2	BCC M425-M414-3A-650-PX0434-003	311
BCC03C3	BCC M425-M414-3A-650-PX0434-006	311
BCC03C4	BCC M425-M414-3A-650-PX0434-010	311
BCC03C5	BCC M425-M414-3A-650-PX0434-015	311
BCC03C6	BCC M425-M414-3A-650-PX0434-020	311
BCC03C7	BCC M425-M414-3A-650-PX0434-030	311
BCC03C8	BCC M425-M414-3A-650-PX0434-050	311
BCC03C9	BCC M415-M414-3A-304-VX8434-003	310
BCC03CA	BCC M415-M414-3A-304-VX8434-006	310
BCC03CC	BCC M415-M414-3A-304-VX8434-010	310
BCC03CE	BCC M415-M414-3A-304-VX8434-015	310
BCC03CF	BCC M415-M414-3A-304-VX8434-020	310
BCC03CH	BCC M415-M414-3A-304-VX8434-030	310
BCC03CJ	BCC M415-M414-3A-304-VX8434-050	310
BCC03CU	BCC M415-M414-3A-606-VX8434-003	310
BCC03CW	BCC M415-M414-3A-606-VX8434-006	310
BCC03CY	BCC M415-M414-3A-606-VX8434-010	310
BCC03CZ	BCC M415-M414-3A-606-VX8434-015	310
BCC03E0	BCC M415-M414-3A-606-VX8434-020	310
BCC03E1	BCC M415-M414-3A-606-VX8434-030	310
BCC03E2	BCC M415-M414-3A-606-VX8434-050	310
BCC03E3	BCC M425-M414-3A-304-VX8434-003	311
BCC03E4	BCC M425-M414-3A-304-VX8434-006	311
BCC03E5	BCC M425-M414-3A-304-VX8434-010	311
BCC03E6	BCC M425-M414-3A-304-VX8434-015	311
BCC03E7	BCC M425-M414-3A-304-VX8434-020	311
BCC03E8	BCC M425-M414-3A-304-VX8434-030	311
BCC03E9	BCC M425-M414-3A-304-VX8434-050	311
BCC03EL	BCC M425-M414-3A-606-VX8434-003	311
BCC03EM	BCC M425-M414-3A-606-VX8434-006	311
BCC03EN	BCC M425-M414-3A-606-VX8434-010	311
BCC03EP	BCC M425-M414-3A-606-VX8434-015	311
BCC03ER	BCC M425-M414-3A-606-VX8434-020	311
BCC03ET	BCC M425-M414-3A-606-VX8434-030	311
BCC03EU	BCC M425-M414-3A-606-VX8434-050	311
BCC03EW	BCC M425-M414-3A-650-VX8434-003	311
BCC03EZ	BCC M425-M414-3A-650-VX8434-010	311
BCC03F0	BCC M425-M414-3A-650-VX8434-015	311
BCC03F1	BCC M425-M414-3A-650-VX8434-020	311
BCC03F2	BCC M425-M414-3A-650-VX8434-030	311
BCC03F3	BCC M425-M414-3A-650-VX8434-050	311
BCC03F4	BCC M313-M413-3E-300-PX0334-003	278
BCC03F5	BCC M313-M413-3E-300-PX0334-006	278
BCC03F6	BCC M313-M413-3E-300-PX0334-010	278
BCC03F7	BCC M313-M413-3E-300-PX0334-015	278
BCC03F8	BCC M313-M413-3E-300-PX0334-020	278

# Alphanumeric index

## Sorted by ordering code

Ordering code	Part number	Page
BCC03F9	BCC M313-M413-3E-300-PX0334-030	278
BCC03FA	BCC M313-M413-3E-300-PX0334-050	278
BCC03FM	BCC M323-M413-3E-300-PX0334-003	278
BCC03FN	BCC M323-M413-3E-300-PX0334-006	278
BCC03FP	BCC M323-M413-3E-300-PX0334-010	278
BCC03FR	BCC M323-M413-3E-300-PX0334-015	278
BCC03FT	BCC M323-M413-3E-300-PX0334-020	278
BCC03FU	BCC M323-M413-3E-300-PX0334-030	278
BCC03FW	BCC M323-M413-3E-300-PX0334-050	278
BCC03H5	BCC M323-M413-3E-602-PX0334-003	279
BCC03H6	BCC M323-M413-3E-602-PX0334-006	279
BCC03H7	BCC M323-M413-3E-602-PX0334-010	279
BCC03H8	BCC M323-M413-3E-602-PX0334-015	279
BCC03H9	BCC M323-M413-3E-602-PX0334-020	279
BCC03HA	BCC M323-M413-3E-602-PX0334-030	279
BCC03HC	BCC M323-M413-3E-602-PX0334-050	279
BCC03HE	BCC M313-M413-3E-300-VX8334-003	278
BCC03HF	BCC M313-M413-3E-300-VX8334-006	278
BCC03HH	BCC M313-M413-3E-300-VX8334-010	278
BCC03HJ	BCC M313-M413-3E-300-VX8334-015	278
BCC03HK	BCC M313-M413-3E-300-VX8334-020	278
BCC03HL	BCC M313-M413-3E-300-VX8334-030	278
BCC03HM	BCC M313-M413-3E-300-VX8334-050	278
BCC03HZ	BCC M323-M413-3E-300-VX8334-003	278
BCC03JO	BCC M323-M413-3E-300-VX8334-006	278
BCC03J1	BCC M323-M413-3E-300-VX8334-010	278
BCC03J2	BCC M323-M413-3E-300-VX8334-015	278
BCC03J3	BCC M323-M413-3E-300-VX8334-020	278
BCC03J4	BCC M323-M413-3E-300-VX8334-030	278
BCC03J5	BCC M323-M413-3E-300-VX8334-050	278
BCC03JF	BCC M323-M413-3E-602-VX8334-003	279
BCC03JH	BCC M323-M413-3E-602-VX8334-006	279
BCC03JJ	BCC M323-M413-3E-602-VX8334-010	279
BCC03JK	BCC M323-M413-3E-602-VX8334-015	279
BCC03JL	BCC M323-M413-3E-602-VX8334-020	279
BCC03JM	BCC M323-M413-3E-602-VX8334-030	279
BCC03JN	BCC M323-M413-3E-602-VX8334-050	279
BCC03JP	BCC M314-M414-3E-304-PX0434-003	280
BCC03JR	BCC M314-M414-3E-304-PX0434-006	280
BCC03JT	BCC M314-M414-3E-304-PX0434-010	280
BCC03JU	BCC M314-M414-3E-304-PX0434-015	280
BCC03JW	BCC M314-M414-3E-304-PX0434-020	280
BCC03JY	BCC M314-M414-3E-304-PX0434-030	280
BCC03JZ	BCC M314-M414-3E-304-PX0434-050	280
BCC03K7	BCC M324-M414-3E-304-PX0434-003	280
BCC03K8	BCC M324-M414-3E-304-PX0434-006	280
BCC03K9	BCC M324-M414-3E-304-PX0434-010	280
BCC03KA	BCC M324-M414-3E-304-PX0434-015	280
BCC03KC	BCC M324-M414-3E-304-PX0434-020	280
BCC03KE	BCC M324-M414-3E-304-PX0434-030	280
BCC03KF	BCC M324-M414-3E-304-PX0434-050	280
BCC03KR	BCC M324-M414-3E-606-PX0434-003	281
BCC03KT	BCC M324-M414-3E-606-PX0434-006	281
BCC03KU	BCC M324-M414-3E-606-PX0434-010	281
BCC03KW	BCC M324-M414-3E-606-PX0434-015	281
BCC03KY	BCC M324-M414-3E-606-PX0434-020	281
BCC03KZ	BCC M324-M414-3E-606-PX0434-030	281
BCC03LO	BCC M324-M414-3E-606-PX0434-050	281
BCC03L1	BCC M314-M414-3E-304-VX8434-003	280
BCC03L2	BCC M314-M414-3E-304-VX8434-006	280
BCC03L3	BCC M314-M414-3E-304-VX8434-010	280
BCC03L4	BCC M314-M414-3E-304-VX8434-015	280
BCC03L5	BCC M314-M414-3E-304-VX8434-020	280

Ordering code	Part number	Page
BCC03L6	BCC M314-M414-3E-304-VX8434-030	280
BCC03L7	BCC M314-M414-3E-304-VX8434-050	280
BCC03LJ	BCC M324-M414-3E-304-VX8434-003	280
BCC03LK	BCC M324-M414-3E-304-VX8434-006	280
BCC03LL	BCC M324-M414-3E-304-VX8434-010	280
BCC03LM	BCC M324-M414-3E-304-VX8434-015	280
BCC03LN	BCC M324-M414-3E-304-VX8434-020	280
BCC03LP	BCC M324-M414-3E-304-VX8434-030	280
BCC03LR	BCC M324-M414-3E-304-VX8434-050	280
BCC03M2	BCC M324-M414-3E-606-VX8434-003	281
BCC03M3	BCC M324-M414-3E-606-VX8434-006	281
BCC03M4	BCC M324-M414-3E-606-VX8434-010	281
BCC03M5	BCC M324-M414-3E-606-VX8434-015	281
BCC03M6	BCC M324-M414-3E-606-VX8434-020	281
BCC03M7	BCC M324-M414-3E-606-VX8434-030	281
BCC03M8	BCC M324-M414-3E-606-VX8434-050	281
BCC03M9	BCC M415-M313-3F-300-PX0334-003	304
BCC03MA	BCC M415-M313-3F-300-PX0334-006	304
BCC03MC	BCC M415-M313-3F-300-PX0334-010	304
BCC03ME	BCC M415-M313-3F-300-PX0334-015	304
BCC03MF	BCC M415-M313-3F-300-PX0334-020	304
BCC03MH	BCC M415-M313-3F-300-PX0334-030	304
BCC03MJ	BCC M415-M313-3F-300-PX0334-050	304
BCC03MU	BCC M425-M313-3F-300-PX0334-003	304
BCC03MW	BCC M425-M313-3F-300-PX0334-006	304
BCC03MY	BCC M425-M313-3F-300-PX0334-010	304
BCC03MZ	BCC M425-M313-3F-300-PX0334-015	304
BCC03N0	BCC M425-M313-3F-300-PX0334-020	304
BCC03N1	BCC M425-M313-3F-300-PX0334-030	304
BCC03N2	BCC M425-M313-3F-300-PX0334-050	304
BCC03NA	BCC M425-M313-3F-602-PX0334-003	305
BCC03NC	BCC M425-M313-3F-602-PX0334-006	305
BCC03NE	BCC M425-M313-3F-602-PX0334-010	305
BCC03NF	BCC M425-M313-3F-602-PX0334-015	305
BCC03NH	BCC M425-M313-3F-602-PX0334-020	305
BCC03NJ	BCC M425-M313-3F-602-PX0334-030	305
BCC03NK	BCC M425-M313-3F-602-PX0334-050	305
BCC03NW	BCC M415-M313-3F-300-VX8334-003	304
BCC03NY	BCC M415-M313-3F-300-VX8334-006	304
BCC03NZ	BCC M415-M313-3F-300-VX8334-010	304
BCC03P0	BCC M415-M313-3F-300-VX8334-015	304
BCC03P1	BCC M415-M313-3F-300-VX8334-020	304
BCC03P2	BCC M415-M313-3F-300-VX8334-030	304
BCC03P3	BCC M415-M313-3F-300-VX8334-050	304
BCC03PC	BCC M425-M313-3F-300-VX8334-003	304
BCC03PE	BCC M425-M313-3F-300-VX8334-006	304
BCC03PF	BCC M425-M313-3F-300-VX8334-010	304
BCC03PH	BCC M425-M313-3F-300-VX8334-015	304
BCC03PJ	BCC M425-M313-3F-300-VX8334-020	304
BCC03PK	BCC M425-M313-3F-300-VX8334-030	304
BCC03PL	BCC M425-M313-3F-300-VX8334-050	304
BCC03PY	BCC M425-M313-3F-602-VX8334-003	305
BCC03PZ	BCC M425-M313-3F-602-VX8334-006	305
BCC03R0	BCC M425-M313-3F-602-VX8334-010	305
BCC03R1	BCC M425-M313-3F-602-VX8334-015	305
BCC03R2	BCC M425-M313-3F-602-VX8334-020	305
BCC03R3	BCC M425-M313-3F-602-VX8334-030	305
BCC03R4	BCC M425-M313-3F-602-VX8334-050	305
BCC03RE	BCC M415-M314-3F-304-PX0434-003	306
BCC03RF	BCC M415-M314-3F-304-PX0434-006	306
BCC03RH	BCC M415-M314-3F-304-PX0434-010	306
BCC03RJ	BCC M415-M314-3F-304-PX0434-015	306
BCC03RK	BCC M415-M314-3F-304-PX0434-020	306

# Alphanumeric index

## Sorted by ordering code

Ordering code	Part number	Page
BCC03RL	BCC M415-M314-3F-304-PX0434-030	306
BCC03RM	BCC M415-M314-3F-304-PX0434-050	306
BCC03RZ	BCC M425-M314-3F-304-PX0434-003	306
BCC03T0	BCC M425-M314-3F-304-PX0434-006	306
BCC03T1	BCC M425-M314-3F-304-PX0434-010	306
BCC03T2	BCC M425-M314-3F-304-PX0434-015	306
BCC03T3	BCC M425-M314-3F-304-PX0434-020	306
BCC03T4	BCC M425-M314-3F-304-PX0434-030	306
BCC03T5	BCC M425-M314-3F-304-PX0434-050	306
BCC03TF	BCC M425-M314-3F-606-PX0434-003	307
BCC03TH	BCC M425-M314-3F-606-PX0434-006	307
BCC03TJ	BCC M425-M314-3F-606-PX0434-010	307
BCC03TK	BCC M425-M314-3F-606-PX0434-015	307
BCC03TL	BCC M425-M314-3F-606-PX0434-020	307
BCC03TM	BCC M425-M314-3F-606-PX0434-030	307
BCC03TN	BCC M425-M314-3F-606-PX0434-050	307
BCC03TP	BCC M415-M314-3F-304-VX8434-003	306
BCC03TR	BCC M415-M314-3F-304-VX8434-006	306
BCC03TT	BCC M415-M314-3F-304-VX8434-010	306
BCC03TU	BCC M415-M314-3F-304-VX8434-015	306
BCC03TW	BCC M415-M314-3F-304-VX8434-020	306
BCC03TY	BCC M415-M314-3F-304-VX8434-030	306
BCC03TZ	BCC M415-M314-3F-304-VX8434-050	306
BCC03U7	BCC M425-M314-3F-304-VX8434-003	306
BCC03U8	BCC M425-M314-3F-304-VX8434-006	306
BCC03U9	BCC M425-M314-3F-304-VX8434-010	306
BCC03UA	BCC M425-M314-3F-304-VX8434-015	306
BCC03UC	BCC M425-M314-3F-304-VX8434-020	306
BCC03UE	BCC M425-M314-3F-304-VX8434-030	306
BCC03UF	BCC M425-M314-3F-304-VX8434-050	306
BCC03UR	BCC M425-M314-3F-606-VX8434-003	307
BCC03UT	BCC M425-M314-3F-606-VX8434-006	307
BCC03UU	BCC M425-M314-3F-606-VX8434-010	307
BCC03UW	BCC M425-M314-3F-606-VX8434-015	307
BCC03UY	BCC M425-M314-3F-606-VX8434-020	307
BCC03UZ	BCC M425-M314-3F-606-VX8434-030	307
BCC03W0	BCC M425-M314-3F-606-VX8434-050	307
BCC03WZ	BCC M474-0000-2D-000-51X475-000	54, 112
BCC03Y0	BCC M484-0000-2D-000-51X475-000	54, 112
BCC03Y1	BCC M474-0000-1D-000-51X475-000	55, 113
BCC03Y2	BCC M484-0000-1D-000-51X475-000	55, 113
BCC03Y4	BCC M425-M414-3A-650-VX8434-006	311
BCC03YC	BCC VB03-0000-10-055-PX0350-020	350
BCC03YE	BCC VB03-0000-10-055-PX0350-050	350
BCC03YF	BCC VB03-0000-10-055-PX0350-100	350
BCC03YH	BCC VB23-0000-10-055-PX0350-020	350
BCC03YJ	BCC VB23-0000-10-055-PX0350-050	350
BCC03YK	BCC VB23-0000-10-055-PX0350-100	350
BCC03YL	BCC VB43-0000-10-055-PX0350-020	352
BCC03YM	BCC VB43-0000-10-055-PX0350-050	352
BCC03YN	BCC VB43-0000-10-055-PX0350-100	352
BCC03YP	BCC VB63-0000-10-055-PX0350-020	352
BCC03YR	BCC VB63-0000-10-055-PX0350-050	352
BCC03YT	BCC VB63-0000-10-055-PX0350-100	352
BCC03ZZ	BCC VB03-0000-10-055-VX8350-020	350
BCC0400	BCC VB03-0000-10-055-VX8350-050	350
BCC0401	BCC VB03-0000-10-055-VX8350-100	350
BCC0402	BCC VB23-0000-10-055-VX8350-020	350
BCC0403	BCC VB23-0000-10-055-VX8350-050	350
BCC0404	BCC VB23-0000-10-055-VX8350-100	350
BCC0405	BCC VB43-0000-10-055-VX8350-020	352
BCC0406	BCC VB43-0000-10-055-VX8350-050	352
BCC0407	BCC VB43-0000-10-055-VX8350-100	352

Ordering code	Part number	Page
BCC0408	BCC VB63-0000-10-055-VX8350-020	352
BCC0409	BCC VB63-0000-10-055-VX8350-050	352
BCC040A	BCC VB63-0000-10-055-VX8350-100	352
BCC04K0	BCC M414-M414-6D-331-PS54T2-006	52
BCC04K1	BCC M414-M414-6D-331-PS54T2-020	52
BCC04K2	BCC M414-M414-6D-331-PS54T2-050	52
BCC04K3	BCC M414-M414-6D-331-PS54T2-100	52
BCC04K4	BCC M414-M414-6D-331-PS54T2-200	52
BCC04K5	BCC M414-M414-6D-331-PS54T2-300	52
BCC04K6	BCC M414-E834-8G-668-PS54T2-006	53
BCC04K7	BCC M414-E834-8G-668-PS54T2-020	53
BCC04K8	BCC M414-E834-8G-668-PS54T2-050	53
BCC04K9	BCC M414-E834-8G-668-PS54T2-100	53
BCC04KA	BCC M414-E834-8G-668-PS54T2-200	53
BCC04KC	BCC M414-E834-8G-668-PS54T2-300	53
BCC04KE	BCC E834-E834-90-334-PS54T2-006	53
BCC04KF	BCC E834-E834-90-334-PS54T2-020	53
BCC04KH	BCC E834-E834-90-334-PS54T2-050	53
BCC04KJ	BCC E834-E834-90-334-PS54T2-100	53
BCC04ZK	BCC E834-E834-90-334-PS54T2-150	53
BCC04KK	BCC E834-E834-90-334-PS54T2-200	53
BCC04KL	BCC E834-E834-90-334-PS54T2-300	53
BCC04MC	BCC M478-0000-1A-000-43X834-000	321
BCC04ME	BCC M488-0000-1A-000-43X834-000	321
BCC04MZ	BCC VC04-0000-10-053-PX0350-020	354
BCC04N0	BCC VC04-0000-10-053-PX0350-050	354
BCC04N1	BCC VC04-0000-10-053-PX0350-100	354
BCC04N2	BCC VC04-0000-10-053-VX8350-020	354
BCC04N3	BCC VC04-0000-10-053-VX8350-050	354
BCC04N4	BCC VC04-0000-10-053-VX8350-100	354
BCC04NC	BCC VC04-M413-3E-664-PX0350-003	354
BCC04NE	BCC VC04-M413-3E-664-PX0350-006	354
BCC04NF	BCC VC04-M413-3E-664-PX0350-010	354
BCC04NH	BCC VC04-M413-3E-664-PX0350-015	354
BCC04NJ	BCC VC04-M413-3E-664-PX0350-020	354
BCC04NK	BCC VC04-M413-3E-664-PX0350-030	354
BCC04NL	BCC VC04-M413-3E-664-PX0350-050	354
BCC04RF	BCC VC44-0000-10-053-PX0350-020	355
BCC04RH	BCC VC44-0000-10-053-PX0350-050	355
BCC04RJ	BCC VC44-0000-10-053-PX0350-100	355
BCC04RK	BCC VC44-0000-10-053-VX8350-020	355
BCC04RL	BCC VC44-0000-10-053-VX8350-050	355
BCC04RM	BCC VC44-0000-10-053-VX8350-100	355
BCC04RY	BCC VC44-M413-3E-664-PX0350-003	355
BCC04RZ	BCC VC44-M413-3E-664-PX0350-006	355
BCC04T0	BCC VC44-M413-3E-664-PX0350-010	355
BCC04T1	BCC VC44-M413-3E-664-PX0350-015	355
BCC04T2	BCC VC44-M413-3E-664-PX0350-020	355
BCC04T3	BCC VC44-M413-3E-664-PX0350-030	355
BCC04T4	BCC VC44-M413-3E-664-PX0350-050	355
BCC04W0	BCC VA04-0000-10-053-PX0350-020	348
BCC04W1	BCC VA04-0000-10-053-PX0350-050	348
BCC04W2	BCC VA04-0000-10-053-PX0350-100	348
BCC04W3	BCC VA04-0000-10-053-VX8350-020	348
BCC04W4	BCC VA04-0000-10-053-VX8350-050	348
BCC04W5	BCC VA04-0000-10-053-VX8350-100	348
BCC04W6	BCC VA04-0000-10-054-PX0350-020	348
BCC04W7	BCC VA04-0000-10-054-PX0350-050	348
BCC04W8	BCC VA04-0000-10-054-PX0350-100	348
BCC04W9	BCC VA04-0000-10-054-VX8350-020	348
BCC04WA	BCC VA04-0000-10-054-VX8350-050	348
BCC04WC	BCC VA04-0000-10-054-VX8350-100	348
BCC04WF	BCC VA04-M413-3E-664-PX0350-003	349



# Alphanumeric index

## Sorted by ordering code

Ordering code	Part number	Page
BCC04WH	BCC VA04-M413-3E-664-PX0350-006	349
BCC04WJ	BCC VA04-M413-3E-664-PX0350-015	349
BCC04WK	BCC VA04-M413-3E-664-PX0350-020	349
BCC04WL	BCC VA04-M413-3E-664-PX0350-030	349
BCC04WM	BCC VA04-M413-3E-664-PX0350-050	349
BCC04ZH	BCC M414-M414-6D-331-PS54T2-150	52
BCC04ZJ	BCC M414-E834-8G-668-PS54T2-150	53
BCC0502	BCC VA04-M413-3E-664-PX0350-010	349
BCC064E	BCC VB03-M413-3E-666-PX0350-003	351
BCC064F	BCC VB03-M413-3E-666-PX0350-006	351
BCC064H	BCC VB03-M413-3E-666-PX0350-010	351
BCC064J	BCC VB03-M413-3E-666-PX0350-015	351
BCC064K	BCC VB03-M413-3E-666-PX0350-020	351
BCC064L	BCC VB03-M413-3E-666-PX0350-030	351
BCC064M	BCC VB03-M413-3E-666-PX0350-050	351
BCC064N	BCC VB23-M413-3E-666-PX0350-003	351
BCC064P	BCC VB23-M413-3E-666-PX0350-006	351
BCC064R	BCC VB23-M413-3E-666-PX0350-010	351
BCC064T	BCC VB23-M413-3E-666-PX0350-015	351
BCC064U	BCC VB23-M413-3E-666-PX0350-020	351
BCC064W	BCC VB23-M413-3E-666-PX0350-030	351
BCC064Y	BCC VB23-M413-3E-666-PX0350-050	351
BCC064Z	BCC VB43-M413-3E-666-PX0350-003	353
BCC0650	BCC VB43-M413-3E-666-PX0350-006	353
BCC0651	BCC VB43-M413-3E-666-PX0350-010	353
BCC0652	BCC VB43-M413-3E-666-PX0350-015	353
BCC0653	BCC VB43-M413-3E-666-PX0350-020	353
BCC0654	BCC VB43-M413-3E-666-PX0350-030	353
BCC0655	BCC VB43-M413-3E-666-PX0350-050	353
BCC0656	BCC VB63-M413-3E-666-PX0350-003	353
BCC0657	BCC VB63-M413-3E-666-PX0350-006	353
BCC0658	BCC VB63-M413-3E-666-PX0350-010	353
BCC0659	BCC VB63-M413-3E-666-PX0350-015	353
BCC065A	BCC VB63-M413-3E-666-PX0350-020	353
BCC065C	BCC VB63-M413-3E-666-PX0350-030	353
BCC065E	BCC VB63-M413-3E-666-PX0350-050	353
BCC06EY	BCC M435-0000-2A-000-51X575-000	318
BCC06F6	BCC M435-0000-1A-000-51X475-000	69, 316
BCC06F7	BCC M434-0000-2A-000-51X475-000	69, 317
BCC06FH	BCC E834-0000-20-000-53X4T2-000	55, 113
BCC06FM	BCC A315-A315-30-335-PX05A5-006	29, 49, 67
BCC06FN	BCC A315-A315-30-335-PX05A5-020	29, 49, 67
BCC06FP	BCC A315-A315-30-335-PX05A5-050	29, 49, 67
BCC06FR	BCC A315-A315-30-335-PX05A5-100	29, 49, 67
BCC06FT	BCC A315-A315-30-335-PX05A5-150	29, 49, 67
BCC06FU	BCC A315-A325-30-335-PX05A5-006	29, 49, 67
BCC06FW	BCC A315-A325-30-335-PX05A5-020	29, 49, 67
BCC06FY	BCC A315-A325-30-335-PX05A5-050	29, 49, 67
BCC06FZ	BCC A315-A325-30-335-PX05A5-100	29, 49, 67
BCC06H0	BCC A315-A325-30-335-PX05A5-150	29, 49, 67
BCC06H1	BCC A325-A315-30-335-PX05A5-006	29, 49, 67
BCC06H2	BCC A325-A315-30-335-PX05A5-020	29, 49, 67
BCC06H3	BCC A325-A315-30-335-PX05A5-050	29, 49, 67
BCC06H4	BCC A325-A315-30-335-PX05A5-100	29, 49, 67
BCC06H5	BCC A325-A315-30-335-PX05A5-150	29, 49, 67
BCC06H6	BCC A325-A325-30-335-PX05A5-006	29, 49, 67
BCC06H7	BCC A325-A325-30-335-PX05A5-020	29, 49, 67
BCC06H8	BCC A325-A325-30-335-PX05A5-050	29, 49, 67
BCC06H9	BCC A325-A325-30-335-PX05A5-100	29, 49, 67
BCC06HA	BCC A325-A325-30-335-PX05A5-150	29, 49, 67
BCC06HC	BCC A315-0000-10-063-PX05A5-020	28, 48, 66
BCC06HE	BCC A315-0000-10-063-PX05A5-050	28, 48, 66
BCC06HF	BCC A315-0000-10-063-PX05A5-100	28, 48, 66

Ordering code	Part number	Page
BCC06HH	BCC A325-0000-10-063-PX05A5-020	28, 48, 66
BCC06HJ	BCC A325-0000-10-063-PX05A5-050	28, 48, 66
BCC06HK	BCC A325-0000-10-063-PX05A5-100	28, 48, 66
BCC06HL	BCC A314-000-20-003-PX04A5-020	82, 116
BCC06HM	BCC A314-000-20-003-PX04A5-050	82, 116
BCC06HN	BCC A314-000-20-003-PX04A5-100	82, 116
BCC06HP	BCC A324-0000-20-003-PX04A5-020	82, 116
BCC06HR	BCC A324-0000-20-003-PX04A5-050	82, 116
BCC06HT	BCC A324-0000-20-003-PX04A5-100	82, 116
BCC06HU	BCC A314-0000-10-003-PX04A5-020	83, 117
BCC06HW	BCC A314-0000-10-003-PX04A5-050	83, 117
BCC06HY	BCC A314-0000-10-003-PX04A5-100	83, 117
BCC06HZ	BCC A324-0000-10-003-PX04A5-020	83, 117
BCC06J0	BCC A324-0000-10-003-PX04A5-050	83, 117
BCC06J1	BCC A324-0000-10-003-PX04A5-100	83, 117
BCC06J2	BCC A314-A314-30-304-PX04A5-006	84, 118
BCC06J3	BCC A314-A314-30-304-PX04A5-020	84, 118
BCC06J4	BCC A314-A314-30-304-PX04A5-050	84, 118
BCC06J5	BCC A314-A314-30-304-PX04A5-100	84, 118
BCC06J6	BCC A314-A314-30-304-PX04A5-150	84, 118
BCC06J7	BCC A314-A324-30-304-PX04A5-006	84, 118
BCC06J8	BCC A314-A324-30-304-PX04A5-020	84, 118
BCC06J9	BCC A314-A324-30-304-PX04A5-050	84, 118
BCC06JA	BCC A314-A324-30-304-PX04A5-100	84, 118
BCC06JC	BCC A314-A324-30-304-PX04A5-150	84, 118
BCC06JE	BCC A324-A314-30-304-PX04A5-006	85, 119
BCC06JF	BCC A324-A314-30-304-PX04A5-020	85, 119
BCC06JH	BCC A324-A314-30-304-PX04A5-050	85, 119
BCC06JJ	BCC A324-A314-30-304-PX04A5-100	85, 119
BCC06JK	BCC A324-A314-30-304-PX04A5-150	85, 119
BCC06JL	BCC A324-A324-30-304-PX04A5-006	85, 119
BCC06JM	BCC A324-A324-30-304-PX04A5-020	85, 119
BCC06JN	BCC A324-A324-30-304-PX04A5-050	85, 119
BCC06JP	BCC A324-A324-30-304-PX04A5-100	85, 119
BCC06JR	BCC A324-A324-30-304-PX04A5-150	85, 119
BCC06K1	BCC M418-0000-1A-044-PX0825-020	300
BCC06K2	BCC M418-0000-1A-044-PX0825-050	300
BCC06K3	BCC M418-0000-1A-044-PX0825-100	300
BCC06K4	BCC M428-0000-1A-044-PX0825-020	301
BCC06K5	BCC M428-0000-1A-044-PX0825-050	301
BCC06K6	BCC M428-0000-1A-044-PX0825-100	301
BCC06M4	BCC M434-0000-2A-000-41X475-000	317
BCC06M7	BCC S415-0000-1A-003-VX8434-100	331
BCC06M8	BCC S415-0000-1A-003-VX8434-150	331
BCC06M9	BCC S415-0000-1A-003-VX8434-200	331
BCC06MA	BCC S415-0000-1A-003-VX8434-250	331
BCC06MC	BCC S415-0000-1A-003-VX8434-300	330
BCC06ME	BCC S415-0000-1A-003-VX8434-350	330
BCC06MF	BCC S425-0000-1A-003-VX8434-100	331
BCC06MH	BCC S425-0000-1A-003-VX8434-150	331
BCC06MJ	BCC S425-0000-1A-003-VX8434-200	331
BCC06MK	BCC S425-0000-1A-003-VX8434-250	331
BCC06ML	BCC S425-0000-1A-003-VX8434-300	330
BCC06MM	BCC S425-0000-1A-003-VX8434-350	330
BCC06U9	BCC S425-0000-1A-004-VX8334-150	330
BCC06UA	BCC S425-0000-1A-004-VX8334-200	330
BCC06UC	BCC S425-0000-1A-004-VX8334-250	330
BCC06UE	BCC S425-0000-1A-004-PX0334-150	330
BCC06UF	BCC S425-0000-1A-004-PX0334-200	330
BCC06UH	BCC S425-0000-1A-004-PX0334-250	330
BCC06UJ	BCC S425-0000-1A-004-PX0334-400	330
BCC06UK	BCC M41C-0000-1A-049-PX0C25-020	239
BCC06UK	BCC M41C-0000-1A-049-PX0C25-020	302

# Alphanumeric index

## Sorted by ordering code

Ordering code	Part number	Page	Ordering code	Part number	Page
BCC06UL	BCC M41C-0000-1A-049-PX0C25-050	239, 302	BCC071C	BCC PA04-0000-10-070-PX0550-050	356
BCC06UM	BCC M41C-0000-1A-049-PX0C25-100	239, 302	BCC071E	BCC PA04-0000-10-070-PX0550-100	356
BCC06UP	BCC M41C-0000-1A-049-VX8C25-020	239, 302	BCC071F	BCC PA24-0000-10-070-PX0550-020	356
BCC06UR	BCC M41C-0000-1A-049-VX8C25-050	239, 302	BCC071H	BCC PA24-0000-10-070-PX0550-050	356
BCC06UT	BCC M41C-0000-1A-049-VX8C25-100	239, 302	BCC071J	BCC PA24-0000-10-070-PX0550-100	356
BCC06UU	BCC M41C-0000-2A-049-PX0C25-020	239, 302	BCC082W	BCC M415-0000-1A-001-PH0334-020	329
BCC06UW	BCC M41C-0000-2A-049-PX0C25-050	239, 302	BCC082Y	BCC M415-0000-1A-001-PH0334-050	329
BCC06UY	BCC M41C-0000-2A-049-PX0C25-100	239, 302	BCC082Z	BCC M415-0000-1A-001-PH0334-100	329
BCC06UZ	BCC M41C-0000-2A-049-VX8C25-020	239, 302	BCC0832	BCC M425-0000-1A-001-PH0334-020	329
BCC06W0	BCC M41C-0000-2A-049-VX8C25-050	239, 302	BCC0833	BCC M425-0000-1A-001-PH0334-050	329
BCC06W1	BCC M41C-0000-2A-049-VX8C25-100	239, 302	BCC0836	BCC M313-0000-10-001-PH0334-050	328
BCC06W9	BCC M435-0000-1A-000-51X575-000	317	BCC084R	BCC M414-0000-2A-068-VS24N7-020	68
BCC06WU	BCC M415-M414-3A-337-VS24N7-006	68	BCC084T	BCC M414-0000-2A-068-VS24N7-050	68
BCC06WW	BCC M415-M414-3A-337-VS24N7-020	68	BCC084U	BCC M414-0000-2A-068-VS24N7-100	68
BCC06WY	BCC M415-M414-3A-337-VS24N7-050	68	BCC085F	BCC M414-E814-BG-RM013-000	50
BCC06WZ	BCC M415-M414-3A-337-VS24N7-100	68	BCC085F	BCC M414-E814-BG-RM013-000	110
BCC06Y0	BCC M415-M414-3A-337-VS24N7-150	68	BCC085H	BCC M424-E814-BG-RM013-000	50, 110
BCC06Y1	BCC M415-0000-1A-068-VS24N7-020	68	BCC085Z	BCC M418-0000-1A-069-PX0825-100	300
BCC06Y2	BCC M415-0000-1A-068-VS24N7-050	68	BCC0860	BCC M415-0000-1A-017-PX0534-100	298
BCC06Y3	BCC M415-0000-1A-068-VS24N7-100	68	BCC086T	BCC M425-0000-1A-001-PW3334-020	340
BCC06Y4	BCC M415-0000-2A-R03	70	BCC086U	BCC M425-0000-1A-001-PW3334-050	340
BCC06Y5	BCC M434-0000-2A-000-55X450-000	69, 317	BCC086W	BCC M425-0000-1A-001-PW3334-100	340
BCC06Y6	BCC M435-0000-1A-000-55X450-000	69, 316	BCC087F	BCC M415-0000-1A-034-PW3534-015	341
BCC06Y8	BCC M445-0000-1A-000-51X475-000	316	BCC087H	BCC M415-0000-1A-034-PW3534-050	341
BCC06YA	BCC M435-0000-2A-000-41X575-000	318	BCC087J	BCC M415-0000-1A-034-PW3534-075	341
BCC06YP	BCC M454-M454-5D-RM002-000	51, 111	BCC087K	BCC M415-0000-1A-034-PW3534-100	341
BCC06YW	BCC M333-0000-10-000-34X325-000	282	BCC087L	BCC M425-0000-1A-040-PW3534-015	341
BCC06YY	BCC M343-0000-10-000-34X325-000	283	BCC087M	BCC M425-0000-1A-040-PW3534-050	341
BCC06YZ	BCC M333-0000-20-000-34X325-000	283	BCC087N	BCC M425-0000-1A-040-PW3534-075	341
BCC06Z0	BCC M343-0000-20-000-34X325-000	283	BCC087P	BCC M425-0000-1A-040-PW3534-100	341
BCC06Z1	BCC M333-0000-10-000-31X350-000	282	BCC087R	BCC M415-M415-3A-313-PW3534-006	343
BCC06Z9	BCC M435-0000-1A-000-41X475-000	316	BCC087T	BCC M415-M415-3A-313-PW3534-010	343
BCC06ZA	BCC M445-0000-1A-000-41X475-000	316	BCC087U	BCC M415-M415-3A-313-PW3534-015	343
BCC06ZC	BCC M444-0000-2A-000-41X475-000	317	BCC087W	BCC M415-M415-3A-313-PW3534-020	343
BCC06ZE	BCC M444-0000-2A-000-51X475-000	317	BCC089P	BCC M415-M415-M415-U0003-000	38, 58, 71, 90, 122, 190, 325
BCC06ZF	BCC M435-000-1A-000-41X575-000	317	BCC08C0	BCC M434-0000-2A-000-43X434-000	318
BCC06ZH	BCC M445-000-1A-000-41X575-000	317	BCC08CM	BCC S425-0000-1A-004-PX0334-020	330
BCC06ZJ	BCC M445-0000-1A-000-51X575-000	317	BCC08CN	BCC S425-0000-1A-004-PX0334-030	330
BCC06ZK	BCC M445-000-2A-000-41X575-000	318	BCC08CP	BCC S425-0000-1A-004-PX0334-050	330
BCC06ZL	BCC M445-0000-2A-000-51X575-000	318	BCC08CR	BCC S425-0000-1A-004-PX0334-100	330
BCC06ZY	BCC M435-0000-1A-000-43X434-000	318	BCC08CU	BCC S425-0000-1A-008-PX0434-050	331
BCC0706	BCC A334-0000-10-000-51X4A5-000	89, 120	BCC08CZ	BCC S323-0000-10-004-PX0334-020	330
BCC0707	BCC A334-0000-10-000-61X4A5-000	89, 120	BCC08E0	BCC S323-0000-10-004-PX0334-050	330
BCC0708	BCC A334-0000-10-000-71X4A5-000	89, 120	BCC08F4	BCC M425-0000-1A-039-PX0534-100	299
BCC0709	BCC A334-0000-20-000-51X4A5-000	89, 120	BCC08F5	BCC M425-0000-1A-039-PX0534-050	299
BCC070A	BCC A334-0000-20-000-61X4A5-000	89, 120	BCC08F6	BCC M425-0000-1A-039-PX0534-020	299
BCC070C	BCC A334-0000-20-000-71X4A5-000	89, 120	BCC08F7	BCC M425-0000-1A-034-PX0534-100	298
BCC070E	BCC A335-0000-10-000-51X5A5-000	34, 56	BCC08F8	BCC M425-0000-1A-034-PX0534-050	298
BCC070F	BCC A335-0000-10-000-61X5A5-000	34, 56	BCC08F9	BCC M425-0000-1A-034-PX0534-020	298
BCC070H	BCC A335-0000-10-000-71X5A5-000	34, 56	BCC08FA	BCC M425-0000-1A-017-PX0534-100	298
BCC070J	BCC A335-0000-20-000-51X5A5-000	34, 56	BCC08FC	BCC M425-0000-1A-017-PX0534-050	298
BCC070K	BCC A335-0000-20-000-61X5A5-000	34, 56	BCC08FE	BCC M415-0000-1A-017-PX0534-020	298
BCC070L	BCC A335-0000-20-000-71X5A5-000	34, 56	BCC08H0	BCC M425-M415-3A-313-PX0534-003	313
BCC070Y	BCC M415-0000-1B-031-PS72N1-020	30	BCC08H1	BCC M425-M415-3A-313-PX0534-006	313
BCC070Z	BCC M415-0000-1B-031-PS72N1-050	30	BCC08H2	BCC M425-M415-3A-313-PX0534-010	313
BCC0710	BCC M415-0000-1B-031-PS72N1-100	30	BCC08H3	BCC M425-M415-3A-313-PX0534-015	313
BCC0714	BCC M475-0000-2B-000-01X575-000	35	BCC08H4	BCC M425-M415-3A-313-PX0534-020	313
BCC0715	BCC M475-0000-1B-000-01X575-000	35	BCC08H5	BCC M425-M415-3A-313-PX0534-030	313
BCC0716	BCC M485-0000-2B-000-01X575-000	35	BCC08H6	BCC M425-M415-3A-313-PX0534-050	313
BCC0717	BCC M485-0000-1B-000-01X575-000	35	BCC08H8	BCC M425-M415-3A-312-PX0534-003	313
BCC0718	BCC M415-0000-2B-R01	36	BCC08H9	BCC M425-M415-3A-312-PX0534-006	313
BCC0719	BCC M415-0000-2B-R02	37	BCC08HA	BCC M425-M415-3A-312-PX0534-010	313
BCC071A	BCC PA04-0000-10-070-PX0550-020	356			

# Alphanumeric index

## Sorted by ordering code

Ordering code	Part number	Page
BCC08HC	BCC M425-M415-3A-312-PX0534-015	313
BCC08HE	BCC M425-M415-3A-312-PX0534-020	313
BCC08HF	BCC M425-M415-3A-312-PX0534-030	313
BCC08HH	BCC M425-M415-3A-312-PX0534-050	313
BCC08HP	BCC M425-0000-1A-040-PX0534-020	299
BCC08HR	BCC M425-0000-1A-040-PX0534-050	299
BCC08HT	BCC M425-0000-1A-040-PX0534-100	299
BCC08JC	BCC M415-0000-2A-034-PX0534-050	294
BCC08JE	BCC M415-0000-2A-034-PX0534-020	294
BCC08LE	BCC M425-0000-1A-004-PW3334-100	340
BCC08MZ	BCC M425-0000-1A-004-PW3334-030	340
BCC098C	BCC M415-0000-1A-017-PX0534-050	298
BCC0994	BCC M418-0000-1A-046-PS0825-020	300
BCC0995	BCC M418-0000-1A-046-PS0825-050	300
BCC0996	BCC M418-0000-1A-046-PS0825-100	300
BCC0997	BCC M428-0000-1A-046-PS0825-020	301
BCC0998	BCC M428-0000-1A-046-PS0825-050	301
BCC0999	BCC M428-0000-1A-046-PS0825-100	301
BCC099A	BCC M454-0000-2A-RM020-005	322
BCC099C	BCC M455-0000-1A-RM020-005	322
BCC099EU	BCC M333-0000-10-000-22X334-000	285
BCC099EW	BCC M333-0000-10-000-22X334-000	285
BCC099EY	BCC M334-0000-10-000-22X434-000	286
BCC099EZ	BCC M334-0000-20-000-22X434-000	286
BCC09F3	BCC M425-M415-3A-661-PX0534-015	314
BCC09F4	BCC M425-M415-3A-661-PX0534-020	314
BCC09F5	BCC M425-M415-3A-661-PX0534-030	314
BCC09F6	BCC M425-M415-3A-661-PX0534-050	314
BCC09F7	BCC M425-M415-3A-661-PX0534-010	314
BCC09F8	BCC M425-M415-3A-661-PX0534-006	314
BCC09F9	BCC M425-M415-3A-661-PX0534-003	314
BCC09FA	BCC M425-M415-3A-660-PX0534-003	313
BCC09FC	BCC M425-M415-3A-660-PX0534-006	313
BCC09FE	BCC M425-M415-3A-660-PX0534-010	313
BCC09FF	BCC M425-M415-3A-660-PX0534-020	313
BCC09FH	BCC M425-M415-3A-660-PX0534-015	313
BCC09FJ	BCC M425-M415-3A-660-PX0534-030	313
BCC09FK	BCC M425-M415-3A-660-PX0534-050	313
BCC09FL	BCC M415-M415-3A-312-PX0534-003	312
BCC09FM	BCC M415-M415-3A-312-PX0534-006	312
BCC09FN	BCC M415-M415-3A-312-PX0534-010	312
BCC09FP	BCC M415-M415-3A-312-PX0534-015	312
BCC09FR	BCC M415-M415-3A-312-PX0534-020	312
BCC09FT	BCC M415-M415-3A-312-PX0534-030	312
BCC09FU	BCC M415-M415-3A-312-PX0534-050	312
BCC09FW	BCC M415-M415-3A-313-PX0534-003	312
BCC09FY	BCC M415-M415-3A-313-PX0534-006	312
BCC09FZ	BCC M415-M415-3A-313-PX0534-010	312
BCC09H0	BCC M415-M415-3A-313-PX0534-015	312
BCC09H1	BCC M415-M415-3A-313-PX0534-020	312
BCC09H2	BCC M415-M415-3A-313-PX0534-030	312
BCC09H3	BCC M415-M415-3A-313-PX0534-050	312
BCC09H4	BCC M415-0000-1A-034-PX0534-020	298
BCC09H5	BCC M415-0000-1A-034-PX0534-050	298
BCC09H6	BCC M415-0000-1A-034-PX0534-100	298
BCC09H7	BCC M425-0000-1A-017-PX0534-020	298
BCC09H8	BCC M428-0000-1A-045-PX0825-020	301
BCC09H9	BCC M428-0000-1A-045-PX0825-050	301
BCC09HA	BCC M428-0000-1A-045-PX0825-100	301
BCC09HC	BCC M418-0000-1A-045-PX0825-020	301
BCC09HE	BCC M418-0000-1A-045-PX0825-050	301
BCC09HF	BCC M418-0000-1A-045-PX0825-100	301
BCC09J3	BCC M418-0000-1A-069-PX0825-020	300

Ordering code	Part number	Page
BCC09J4	BCC M418-0000-1A-069-PX0825-050	300
BCC09J6	BCC M415-0000-1A-003-PW3434-020	340
BCC09J8	BCC M425-0000-1A-004-PW3334-020	340
BCC09JC	BCC M415-M313-M313-U0014-000	325
BCC09JP	BCC M435-0000-1A-000-A1X575-000	320
BCC09JW	BCC M435-0000-2A-000-A1X575-000	320
BCC09JZ	BCC M455-0000-1A-RM014-005	323
BCC09K0	BCC M455-0000-2A-RM014-005	323
BCC09M1	BCC M415-M415-3A-313-PW3534-050	343
BCC09M2	BCC M415-M415-3A-313-PW3534-030	343
BCC09MR	BCC M415-0000-2A-R04	86
BCC09MU	BCC M415-M415-M415-U0016-000	325
BCC09NL	BCC M414-M414-6D-338-ES64N9-006	106
BCC09NN	BCC M414-M414-6D-338-ES64N9-020	106
BCC09NP	BCC M414-M414-6D-338-ES64N9-050	106
BCC09NR	BCC M414-M414-6D-338-ES64N9-100	106
BCC09NT	BCC M414-M414-6D-338-ES64N9-150	106
BCC09UY	BCC A315-0000-10-030-VS85N6-020	80
BCC09W0	BCC A315-0000-10-030-VS85N6-050	80
BCC09W3	BCC A315-0000-10-030-VS85N6-100	80
BCC09W8	BCC A315-0000-20-030-VS85N6-020	80
BCC09WA	BCC A315-0000-20-030-VS85N6-050	80
BCC09WF	BCC A315-0000-20-030-VS85N6-100	80
BCC09YA	BCC A315-A315-30-330-VS85N6-006	80
BCC09YE	BCC A315-A315-30-330-VS85N6-020	80
BCC09YJ	BCC A315-A315-30-330-VS85N6-050	80
BCC09YP	BCC A315-A315-30-330-VS85N6-100	80
BCC09YT	BCC A315-A315-30-330-VS85N6-150	80
BCC0A07	BCC M313-M313-M313-U2017-003	287
BCC0A08	BCC M415-0000-1A-R04	86
BCC0A09	BCC A315-0000-2A-R04	86
BCC0A0A	BCC A315-0000-1A-R04	86
BCC0A0Y	BCC M412-0000-2B-031-PS72N1-020	30
BCC0A0Z	BCC M412-0000-2B-031-PS72N1-050	30
BCC0A10	BCC M412-0000-2B-031-PS72N1-100	30
BCC0A12	BCC M415-M412-3B-329-PS72N1-006	30
BCC0A13	BCC M415-M412-3B-329-PS72N1-010	30
BCC0A14	BCC M415-M412-3B-329-PS72N1-020	30
BCC0A15	BCC M415-M412-3B-329-PS72N1-050	30
BCC0A16	BCC M415-M412-3B-329-PS72N1-100	30
BCC0A17	BCC M415-M412-3B-329-PS72N1-150	30
BCC0A18	BCC M415-M412-3B-329-PS72N1-200	30
BCC0A2F	BCC S323-0000-10-004-PX0334-030	330
BCC0A2H	BCC S323-0000-10-004-PX0334-100	330
BCC0A2K	BCC S425-0000-1A-008-PX0434-100	331
BCC0A2L	BCC S425-0000-1A-004-VX8334-050	330
BCC0A2M	BCC S425-0000-1A-004-VX8334-100	330
BCC0A77	BCC M314-M313-30-300-PX0334-010	276
BCC0A78	BCC M314-M313-30-300-PX0334-020	276
BCC0AA6	BCC A314-A314-A314-T0022-000	88, 114
BCC0AA7	BCC A315-A315-A315-T0023-000	36, 57, 70, 87
BCC0AA8	BCC M425-0000-1A-001-PH0334-100	329
BCC0AA9	BCC M415-0000-1A-003-PH0434-020	329
BCC0AAA	BCC M415-0000-1A-003-PH0434-050	329
BCC0AAC	BCC M415-0000-1A-003-PH0434-100	329
BCC0AAE	BCC M425-0000-1A-003-PH0434-020	329
BCC0AAF	BCC M425-0000-1A-003-PH0434-050	329
BCC0AAH	BCC M425-0000-1A-003-PH0434-100	329
BCC0AAZ	BCC M418-M418-3A-342-PX0825-006	315
BCC0AC0	BCC M418-M418-3A-342-PX0825-003	315
BCC0AC1	BCC M418-M418-3A-342-PX0825-010	315
BCC0AC2	BCC M418-M418-3A-342-PX0825-015	315
BCC0AC3	BCC M418-M418-3A-342-PX0825-020	315



# Alphanumeric index

## Sorted by ordering code

Ordering code	Part number	Page
<b>BCC0AC4</b>	BCC M418-M418-3A-342-PX0825-030	315
<b>BCC0AC5</b>	BCC M418-M418-3A-342-PX0825-050	315
<b>BCC0AFL</b>	BCC M314-M313-M313-U2024-003	287
<b>BCC0AFM</b>	BCC M314-M313-M313-U2024-010	287
<b>BCC0AFW</b>	BCC M414-M313-M313-U2026-006	326
<b>BCC0AFY</b>	BCC M414-M313-M313-U2026-010	326
<b>BCC0AFZ</b>	BCC M414-M313-M313-U2026-020	326
<b>BCC0AHO</b>	BCC M414-M313-M313-U2026-030	326
<b>BCC0AJC</b>	BCC M415-M415-3A-313-PX0534-100	312
<b>BCC0AJJ</b>	BCC M415-M415-3A-313-PW0534-006	337
<b>BCC0AJK</b>	BCC M313-0000-10-001-PW0334-050	333
<b>BCC0AJM</b>	BCC M314-0000-10-003-PW0434-050	333
<b>BCC0AJR</b>	BCC M323-0000-10-001-PW0334-050	333
<b>BCC0AJW</b>	BCC M324-0000-10-003-PW0434-050	333
<b>BCC0AK1</b>	BCC M414-M415-M415-U2027-003	337
<b>BCC0AK2</b>	BCC M414-M415-M415-U2027-006	337
<b>BCC0AK3</b>	BCC M414-M415-M415-U2027-010	337
<b>BCC0AK4</b>	BCC M415-0000-1A-003-PW0434-020	335
<b>BCC0AK5</b>	BCC M415-0000-1A-003-PW0434-050	335
<b>BCC0AK6</b>	BCC M415-0000-1A-003-PW0434-100	335
<b>BCC0AK7</b>	BCC M415-M415-3A-313-PW0534-010	337
<b>BCC0AK8</b>	BCC M415-M415-3A-313-PW0534-020	337
<b>BCC0AK9</b>	BCC M415-M415-3A-313-PW0534-030	337
<b>BCC0AKA</b>	BCC M415-M415-3A-313-PW0534-050	337
<b>BCC0AKE</b>	BCC M425-0000-1A-003-PW0434-050	335
<b>BCC0AKF</b>	BCC M425-0000-1A-003-PW0434-100	335
<b>BCC0AKH</b>	BCC M425-M415-3A-313-PW0534-006	337
<b>BCC0AKJ</b>	BCC M425-M415-3A-313-PW0534-010	337
<b>BCC0AKK</b>	BCC M425-M415-3A-313-PW0534-020	337
<b>BCC0AKL</b>	BCC M425-M415-3A-313-PW0534-030	337
<b>BCC0AKM</b>	BCC M425-M415-3A-313-PW0534-050	337
<b>BCC0AN9</b>	BCC M415-0000-1A-017-VX8534-100	298
<b>BCC0ANE</b>	BCC M425-M414-3A-650-PW0434-003	336
<b>BCC0ANF</b>	BCC M425-M414-3A-650-PW0434-006	336
<b>BCC0ANH</b>	BCC M425-M414-3A-650-PW0434-010	336
<b>BCC0ANJ</b>	BCC M425-M414-3A-650-PW0434-015	336
<b>BCC0ANK</b>	BCC M425-M414-3A-650-PW0434-020	336
<b>BCC0ANM</b>	BCC M425-M414-3A-650-PW0434-050	336
<b>BCC0ANP</b>	BCC M425-M414-3A-304-PW0434-003	336
<b>BCC0ANR</b>	BCC M425-M414-3A-304-PW0434-006	336
<b>BCC0ANT</b>	BCC M425-M414-3A-304-PW0434-010	336
<b>BCC0ANU</b>	BCC M425-M414-3A-304-PW0434-015	336
<b>BCC0ANW</b>	BCC M425-M414-3A-304-PW0434-020	336
<b>BCC0ANZ</b>	BCC M425-M414-3A-304-PW0434-050	336
<b>BCC0AP1</b>	BCC M415-M414-3A-304-PW0434-003	336
<b>BCC0AP2</b>	BCC M415-M414-3A-304-PW0434-006	336
<b>BCC0AP3</b>	BCC M415-M414-3A-304-PW0434-010	336
<b>BCC0AP4</b>	BCC M415-M414-3A-304-PW0434-015	336
<b>BCC0AP5</b>	BCC M415-M414-3A-304-PW0434-020	336
<b>BCC0AP7</b>	BCC M415-M414-3A-304-PW0434-050	336
<b>BCC0AT5</b>	BCC M415-0000-1A-017-VX8534-050	298
<b>BCC0AT6</b>	BCC M415-0000-2A-017-VX8534-050	294
<b>BCC0AU3</b>	BCC M415-0000-2A-017-VX8534-020	294
<b>BCC0AUA</b>	BCC M414-M415-M415-U2028-003	326
<b>BCC0AUC</b>	BCC M414-M415-M415-U2028-006	326
<b>BCC0AUE</b>	BCC M414-M415-M415-U2028-010	326
<b>BCC0AUF</b>	BCC M414-M415-M415-U2028-020	326
<b>BCC0AUH</b>	BCC M414-M415-M415-U2028-030	326
<b>BCC0AUJ</b>	BCC M415-0000-2A-017-VX8534-100	294
<b>BCC0AUL</b>	BCC M314-M313-30-300-PX0334-006	276
<b>BCC0AW9</b>	BCC M313-0000-10-004-PX0334-020	271
<b>BCC0AWA</b>	BCC M313-0000-10-004-PX0334-050	271
<b>BCC0AWC</b>	BCC M313-0000-10-004-PX0334-100	271

Ordering code	Part number	Page
<b>BCC0AYO</b>	BCC M313-0000-10-004-VX8334-050	271
<b>BCC0AZA</b>	BCC M313-M313-30-602-PX0334-003	274
<b>BCC0AZC</b>	BCC M313-M313-30-602-PX0334-006	274
<b>BCC0AZE</b>	BCC M313-M313-30-602-PX0334-010	274
<b>BCC0AZF</b>	BCC M313-M313-30-602-PX0334-015	274
<b>BCC0AZH</b>	BCC M313-M313-30-602-PX0334-020	274
<b>BCC0AZJ</b>	BCC M313-M313-30-602-PX0334-030	274
<b>BCC0AZK</b>	BCC M313-M313-30-602-PX0334-050	274
<b>BCC0C06</b>	BCC M313-0000-10-004-VX8334-020	271
<b>BCC0C07</b>	BCC M313-0000-10-004-VX8334-100	271
<b>BCC0C0M</b>	BCC M415-M415-3A-313-PW0534-015	337
<b>BCC0CON</b>	BCC M425-M415-3A-661-PW0534-006	337
<b>BCC0COP</b>	BCC M425-M415-3A-661-PW0534-010	337
<b>BCC0COR</b>	BCC M425-M415-3A-661-PW0534-015	337
<b>BCC0COT</b>	BCC M425-M415-3A-661-PW0534-020	337
<b>BCC0COU</b>	BCC M425-M415-3A-661-PW0534-030	337
<b>BCC0COW</b>	BCC M425-M415-3A-661-PW0534-050	337
<b>BCC0COY</b>	BCC D259-M414-M415-U0029-000-C011	31
<b>BCC0COZ</b>	BCC D269-M414-M415-U0029-000-C011	31
<b>BCC0C10</b>	BCC D279-0000-E0-000-65X4N1-000-C011	31
<b>BCC0C11</b>	BCC D289-0000-E0-000-65X4N1-000-C011	31
<b>BCC0C20</b>	BCC M324-0000-10-003-PW3434-050	339
<b>BCC0C21</b>	BCC M314-0000-10-003-PW3434-050	339
<b>BCC0C22</b>	BCC M425-0000-1A-003-PW3434-050	341
<b>BCC0C23</b>	BCC M415-0000-1A-003-PW3434-050	340
<b>BCC0C24</b>	BCC M323-0000-10-001-PW3334-050	339
<b>BCC0C27</b>	BCC M414-M415-M415-U2027-020	337
<b>BCC0C3A</b>	BCC M313-0000-10-001-PW3334-050	339
<b>BCC0C3Z</b>	BCC M425-0000-1A-099-PW3434-020	341
<b>BCC0C41</b>	BCC M425-0000-1A-099-PW3434-050	341
<b>BCC0C42</b>	BCC M425-0000-1A-099-PW3434-100	341
<b>BCC0C49</b>	BCC M425-M415-3A-692-PW0534-050	314
<b>BCC0C4A</b>	BCC M425-M415-3A-692-PX0534-030	314
<b>BCC0C4C</b>	BCC M425-M415-3A-692-PX0534-020	314
<b>BCC0C4E</b>	BCC M425-M415-3A-692-PX0534-015	314
<b>BCC0C4F</b>	BCC M425-M415-3A-692-PX0534-010	314
<b>BCC0C4H</b>	BCC M425-M415-3A-692-PX0534-006	314
<b>BCC0C4J</b>	BCC M425-M415-3A-692-PX0534-003	314
<b>BCC0C4K</b>	BCC M425-M414-3A-691-PW3434-003	343
<b>BCC0C4L</b>	BCC M425-M414-3A-691-PW3434-010	343
<b>BCC0C4M</b>	BCC M425-M414-3A-691-PW3434-015	343
<b>BCC0C4N</b>	BCC M425-M414-3A-691-PW3434-020	343
<b>BCC0C4P</b>	BCC M425-M414-3A-691-PW3434-030	343
<b>BCC0C4R</b>	BCC M425-M414-3A-691-PW3434-050	343
<b>BCC0C4T</b>	BCC M425-M415-3A-692-PW3534-003	343
<b>BCC0C4U</b>	BCC M425-M415-3A-692-PW3534-006	343
<b>BCC0C4W</b>	BCC M425-M415-3A-692-PW3534-010	343
<b>BCC0C4Y</b>	BCC M425-M415-3A-692-PW3534-015	343
<b>BCC0C4Z</b>	BCC M425-M415-3A-692-PW3534-020	343
<b>BCC0C50</b>	BCC M425-M415-3A-692-PW3534-030	343
<b>BCC0C51</b>	BCC M425-M415-3A-692-PW3534-050	343
<b>BCC0C52</b>	BCC M425-M414-3A-691-PW3434-006	343
<b>BCC0C6A</b>	BCC M314-M313-30-300-PX0334-030	276
<b>BCC0C6C</b>	BCC M314-M313-30-300-PX0334-050	276
<b>BCC0C6E</b>	BCC M415-0000-1B-R01	37
<b>BCC0C76</b>	BCC M415-0000-2A-017-PX0534-020	294
<b>BCC0C77</b>	BCC M415-0000-2A-017-PX0534-050	294
<b>BCC0C78</b>	BCC M415-0000-2A-017-PX0534-100	294
<b>BCC0C7A</b>	BCC M414-M415-M415-U2032-003	344
<b>BCC0C7C</b>	BCC M414-M415-M415-U2032-006	344
<b>BCC0C7E</b>	BCC M414-M415-M415-U2032-010	344
<b>BCC0C7T</b>	BCC M425-0000-1A-100-PW3534-050	342
<b>BCC0C7U</b>	BCC M425-0000-1A-100-PW3534-020	342

# Alphanumeric index

## Sorted by ordering code

Ordering code	Part number	Page
<b>BCC0C7U</b>	BCC M425-0000-1A-100-PW3534-100	342
<b>BCC0C7W</b>	BCC M415-0000-1A-003-PW3434-100	340
<b>BCC0C9N</b>	BCC M414-M425-M425-U2034-030	326
<b>BCC0C9P</b>	BCC M414-M425-M425-U2034-020	326
<b>BCC0C9R</b>	BCC M414-M425-M425-U2034-010	326
<b>BCC0C9T</b>	BCC M414-M425-M425-U2034-006	326
<b>BCC0C9U</b>	BCC M414-M425-M425-U2034-003	326
<b>BCC0CA2</b>	BCC M414-M425-M425-U2035-003	344
<b>BCC0CA3</b>	BCC M414-M425-M425-U2035-006	344
<b>BCC0CA4</b>	BCC M414-M425-M425-U2035-010	344
<b>BCC0CA5</b>	BCC M414-M425-M425-U2035-020	344
<b>BCC0CA6</b>	BCC M414-M425-M425-U2035-030	344
<b>BCC0CAA</b>	BCC S445-0000-1A-000-51X475-000-C024	345
<b>BCC0CAE</b>	BCC M455-0000-1A-RM020-020	322
<b>BCC0CAH</b>	BCC M314-M313-30-300-PX0334-003	276
<b>BCC0CAP</b>	BCC M313-0000-10-001-PW0334-100	333
<b>BCC0CLZ</b>	BCC M414-M414-6D-366-EX64N9-020	108
<b>BCC0CM1</b>	BCC M414-M414-6D-366-EX64N9-050	108
<b>BCC0CM3</b>	BCC M414-M414-6D-366-EX64N9-100	108
<b>BCC0CNP</b>	BCC M414-E834-8G-695-EX64N9-050	109
<b>BCC0CNR</b>	BCC M414-E834-8G-695-EX64N9-100	109
<b>BCC0CNT</b>	BCC M414-E834-8G-695-EX64N9-150	109
<b>BCC0CNU</b>	BCC E834-E834-90-367-EX64N9-150	109
<b>BCC0CT8</b>	BCC S425-0000-1A-008-VX0434-250	331
<b>BCC0CT9</b>	BCC S425-0000-1A-008-VX0434-200	331
<b>BCC0CTA</b>	BCC S425-0000-1A-008-VX0434-150	331
<b>BCC0CTC</b>	BCC S425-0000-1A-008-VX0434-100	331
<b>BCC0CTE</b>	BCC S425-0000-1A-008-VX0434-050	331
<b>BCC0CZA</b>	BCC M414-E834-8G-672-ES64N9-006	107
<b>BCC0CZB</b>	BCC M414-E834-8G-672-ES64N9-020	107
<b>BCC0CZE</b>	BCC M414-E834-8G-672-ES64N9-050	107
<b>BCC0CZF</b>	BCC M414-E834-8G-672-ES64N9-100	107
<b>BCC0CZH</b>	BCC M414-E834-8G-672-ES64N9-150	107
<b>BCC0CZJ</b>	BCC E834-E834-90-339-ES64N9-006	107
<b>BCC0CZK</b>	BCC E834-E834-90-339-ES64N9-020	107
<b>BCC0CZL</b>	BCC E834-E834-90-339-ES64N9-050	107
<b>BCC0CZM</b>	BCC E834-E834-90-339-ES64N9-100	107
<b>BCC0CZN</b>	BCC E834-E834-90-339-ES64N9-150	107
<b>BCC0CZR</b>	BCC E834-E834-90-367-EX64N9-006	109
<b>BCC0CZR</b>	BCC E834-E834-90-367-EX64N9-020	109
<b>BCC0CZT</b>	BCC E834-E834-90-367-EX64N9-050	109
<b>BCC0CZU</b>	BCC E834-E834-90-367-EX64N9-100	109
<b>BCC0CZW</b>	BCC M415-0000-1A-030-VS85N6-020	81
<b>BCC0CZY</b>	BCC M415-0000-1A-030-VS85N6-050	81
<b>BCC0CZZ</b>	BCC M415-0000-1A-030-VS85N6-100	81
<b>BCC0E00</b>	BCC M415-0000-2A-030-VS85N6-020	81
<b>BCC0E01</b>	BCC M415-0000-2A-030-VS85N6-050	81
<b>BCC0E02</b>	BCC M415-0000-2A-030-VS85N6-100	81
<b>BCC0E03</b>	BCC M415-M415-3A-330-VS85N6-006	81
<b>BCC0E04</b>	BCC M415-M415-3A-330-VS85N6-020	81
<b>BCC0E05</b>	BCC M415-M415-3A-330-VS85N6-050	81
<b>BCC0E06</b>	BCC M415-M415-3A-330-VS85N6-100	81
<b>BCC0E07</b>	BCC M415-M415-3A-330-VS85N6-150	81
<b>BCC0E08</b>	BCC M414-M414-6D-366-EX64N9-006	108
<b>BCC0E09</b>	BCC M414-M414-6D-366-EX64N9-150	108
<b>BCC0E0A</b>	BCC M414-E834-8G-695-EX64N9-006	109
<b>BCC0E0C</b>	BCC M414-E834-8G-695-EX64N9-020	109
<b>BCC0E2Z</b>	BCC M354-0000-20-RM050-005	289
<b>BCC0E32</b>	BCC M354-0000-20-RM050-020	289
<b>BCC0E35</b>	BCC M354-0000-10-RM050-005	289
<b>BCC0E38</b>	BCC M354-0000-10-RM050-020	289
<b>BCC0E3Z</b>	BCC M455-0000-1B-RM080-002	32
<b>BCC0E40</b>	BCC M452-0000-2B-RM080-002	32

Ordering code	Part number	Page
<b>BCC0E4Y</b>	BCC M353-0000-10-RM049-005	289
<b>BCC0E4Z</b>	BCC M353-0000-10-RM049-020	289
<b>BCC0E50</b>	BCC M353-0000-20-RM049-005	289
<b>BCC0E51</b>	BCC M353-0000-20-RM049-020	289
<b>BCC0E53</b>	BCC M454-0000-2A-RM020-020	322
<b>BCC0E54</b>	BCC M455-0000-1A-RM014-020	323
<b>BCC0E55</b>	BCC M458-0000-1A-RM015-005	323
<b>BCC0E56</b>	BCC M458-0000-1A-RM015-020	323
<b>BCC0E57</b>	BCC M458-0000-2A-RM015-005	323
<b>BCC0E58</b>	BCC M458-0000-2A-RM015-020	323
<b>BCC0E59</b>	BCC M45C-0000-1A-RM081-005	324
<b>BCC0E5A</b>	BCC M45C-0000-1A-RM081-020	324
<b>BCC0E5C</b>	BCC M45C-0000-2A-RM081-005	324
<b>BCC0E5E</b>	BCC M45C-0000-2A-RM081-020	324
<b>BCC0E5F</b>	BCC M455-0000-2A-RM014-020	323
<b>BCC0E7N</b>	BCC M333-0000-20-000-31X350-000-C027	283
<b>BCC0JA</b>	BCC M415-0000-2A-034-PX0534-100	294

### BCS

<b>BCS0001</b>	BCS 20MG10-XPA1Y-8B-03	198
----------------	------------------------	-----

### BES

<b>BES02M5</b>	BES 113-3019-SA1-S4	198
<b>BES02M8</b>	BES 113-356-SA31-S4	198
<b>BES02MC</b>	BES 113-356-SA6-S4	198
<b>BES03EL</b>	BES M08EI-PSY15B-S04G-D01	199
<b>BES03EM</b>	BES M08EH1-PSY25F-S04G-D01	199
<b>BES03EN</b>	BES M08EI-PSY15B-S49G-D01	199
<b>BES03EP</b>	BES M08EH-PSY25F-S49G-D01	199
<b>BES03ER</b>	BES M12MI-PSY20B-S04G-D01	199
<b>BES03ET</b>	BES M12MH-PSY40F-S04G-D01	199
<b>BES03EU</b>	BES M18MI-PSY50B-S04G-D01	199
<b>BES03EW</b>	BES M18MG-PSY80F-S04G-D01	199
<b>BES03EY</b>	BES M30MI-PSY10B-S04G-D01	199
<b>BES03EZ</b>	BES M30MF1-PSY15F-S04G-D01	199

### BFS

<b>BFS000F</b>	BFS 26K-GI-L04-S92	158
----------------	--------------------	-----

### BGL

<b>BGL0035</b>	BGL 30C-007-S4	157
<b>BGL0036</b>	BGL 30C-009-S4	200
<b>BGL003F</b>	BGL 50C-007-S4	157
<b>BGL003H</b>	BGL 50C-009-S4	200
<b>BGL003N</b>	BGL 30A-013-S49	200
<b>BGL003P</b>	BGL 50A-013-S49	200
<b>BGL003R</b>	BGL 80A-013-S49	200

### BIC

<b>BIC0004</b>	BPN 18M-F-02-03	210
<b>BIC0005</b>	BPN 18M-F-03-PU-03	210
<b>BIC0006</b>	BPN 30M-B-04-PU-03	210
<b>BIC0007</b>	BIC 1P0-P2A50-M30MI3-SM4A4A	233
<b>BIC0008</b>	BIC 2P0-P2A50-M30MI3-SM4A5A	233
<b>BIC0009</b>	BIC 1I3-P2A50-M30MI3-SM4ACA	234
<b>BIC000A</b>	BIC 2I3-P2A50-M30MI3-SM4ACA	234
<b>BIC000C</b>	BIC 1I0-I2A50-M30MI3-SM4A4A	235
<b>BIC000E</b>	BIC 2I0-I2A50-M30MI3-SM4A5A	235
<b>BIC000W</b>	BIC 1I3-P2A40-M30M02-BPX0B-050	213
<b>BIC000Y</b>	BIC 2I3-P2A40-M30ME2-BPX09-050	213
<b>BIC0011</b>	BIC 1I3-P2A40-M18MN2-BPX0B-050	213
<b>BIC0012</b>	BIC 2I3-P2A40-M18MF2-BPX09-050	213
<b>BIC0015</b>	BIC 1I2-P2A02-M18MN2-EPX07-050	218



# Alphanumeric index

## Sorted by ordering code

Ordering code	Part number	Page
<b>BIC001A</b>	BIC 112-P2A03-M30M02-EPX07-050	218
<b>BIC001J</b>	BIC 113-P2A05-Q80KA-GPX0C-050	219
<b>BIC001N</b>	BIC 212-P2A02-M18MF2-EPX07-050	218
<b>BIC001T</b>	BIC 212-P2A03-M30MF2-EPX07-050	218
<b>BIC001Y</b>	BIC 213-P2A05-Q80KA-GPX0C-050	219
<b>BIC0021</b>	BIC 213-P2A20-Q40AA-GPX0B-050*	220
<b>BIC0022</b>	BIC 213-P2A20-Q40AC-GPX0B-050	220
<b>BIC0023</b>	BIC 213-P2A30-Q90AA-GPX0B-050	221
<b>BIC0026</b>	BIC 113-P2A20-Q40AA-GPX0B-050	220
<b>BIC0027</b>	BIC 113-P2A20-Q40AC-GPX0B-050	220
<b>BIC0028</b>	BIC 113-P2A30-Q90AA-GPX0B-050	221
<b>BIC0029</b>	BIC 110-P2A02-M18MI-BPX03-050	214
<b>BIC002C</b>	BIC 110-N2A02-M18MI-BPX03-020	214
<b>BIC002E</b>	BIC 110-P2A02-M30MI-BPX03-050	215
<b>BIC002K</b>	BIC 210-P2A02-M18ME-BPX03-020	214
<b>BIC002L</b>	BIC 210-N2A02-M18ME-BPX03-010	214
<b>BIC002P</b>	BIC 110-P2001-M18MI-BPX03-050	212
<b>BIC002T</b>	BIC 110-P2001-M12MM1-BPX03-050	212
<b>BIC0039</b>	BIC 2B2-P2A30-Q90AQ-GPX0B-050	223
<b>BIC003C</b>	BIC 1B2-P2A30-Q90AQ-GPX0B-050	223
<b>BIC003N</b>	BIC 113-P2A16-R01K01-C03	225
<b>BIC003P</b>	BIC 213-P2A16-R01K01-SM3A30	225
<b>BIC003W</b>	BIC 210-D1001-M12ME1-BPX02-050	212
<b>BIC003Z</b>	BIC 210-D1001-M18ME1-BPX02-050	212
<b>BIC0041</b>	BIC 210-R1002-M18MF2-BPX03-050	229
<b>BIC0043</b>	BIC 210-V1A01-M18MI2-BPX03-050	228
<b>BIC0044</b>	BIC 210-P2A05-M30MF-BPX03-030	215
<b>BIC0045</b>	BIC 213-P2A15-M30MI2-BPX0B-050	221
<b>BIC0046</b>	BIC 110-V1003-M18MN2-BPX03-050	228
<b>BIC0047</b>	BIC 110-C1A02-M18MN2-BPX03-050	229
<b>BIC0048</b>	BIC 113-P2A15-M30MM3-BPX0B-050	221
<b>BIC0049</b>	BIC 112-V1A18-R01K01-C01	227
<b>BIC004A</b>	BIC 212-V1A18-R01K01-SM3A30	227
<b>BIC004C</b>	BIC 210-R3002-M18MF2-BPX03-050	229
<b>BIC004M</b>	BIC 915-D2-M08EE-EPX02-010	211
<b>BIC004N</b>	BIC 902-D2-M12ME-EPX02-020	211
<b>BIC004P</b>	BIC 902-D2-M12ME-EPX02-100	211
<b>BIC004R</b>	BIC 902-D2-M12ME-EPX02-150	211
<b>BIC004W</b>	BIC 905-D2-M18ME-EPX02-010	211
<b>BIC0050</b>	BIC 910-D2-M30MF-EPX02-010	211
<b>BIC0051</b>	BIC 1P0-P2A20-M30ME-SM4A4A	233
<b>BIC0052</b>	BIC 2P0-P2A20-M30ME1-SM4A5A	233
<b>BIC0053</b>	BIC 110-IAA50-M30MI3-SM4A4A	235
<b>BIC0054</b>	BIC 210-IAA50-M30MI3-SM4A5A	235
<b>BIC005A</b>	BIC 110-I2A50-Q40KFU-SM4A4A	237
<b>BIC005C</b>	BIC 210-I2A50-Q40KFU-SM4A5A	237
<b>BIC005K</b>	BIC 210-P2A02-M30TI-BPX03-030	217
<b>BIC005L</b>	BIC 110-P2A02-M30TI-BPX03-030	217
<b>BIC005M</b>	BIC 210-D2A02-M30TI-BPX03-030	217
<b>BIC005N</b>	BIC 110-N2A02-M30TI-BPX03-030	217
<b>BIC005P</b>	BIC 210-N2A02-M18TI-BPX03-050	216
<b>BIC005R</b>	BIC 210-D2A02-M18TI-BPX03-050	216
<b>BIC005T</b>	BIC 110-N2A02-M18TI-BPX03-050	216
<b>BIC0069</b>	BIC 112-N1A02-M18MN2-EPX07-050	218
<b>BIC006A</b>	BIC 113-N1A15-M30MM3-BPX0B-050	221

<b>BIS</b>		
<b>BIS00CZ</b>	BIS L-409-045-001-07-S4	164
<b>BIS00E0</b>	BIS L-409-045-002-07-S4	165
<b>BIS00E1</b>	BIS L-409-045-003-07-S4	165
<b>BIS00E2</b>	BIS L-409-045-004-07-S4	165
<b>BIS00LH</b>	BIS M-400-045-001-07-S4	166
<b>BIS00LJ</b>	BIS M-400-045-002-07-S4	166

Ordering code	Part number	Page
<b>BIS00LK</b>	BIS M-401-045-001-07-S4	168
<b>BIS00LM</b>	BIS M-451-045-001-07-S4	168
<b>BIS00LW</b>	BIS M-402-045-002-07-S4	167
<b>BIS00M1</b>	BIS M-402-045-004-07-S4	167
<b>BIS00T3</b>	BIS V-6102-019-C001	163
<b>BIS00U9</b>	BIS V-6110-063-C002	163
<b>BIS0102</b>	BIS M-401-072-001-07-S4	166
<b>BIS0103</b>	BIS M-451-072-001-07-S4	166
<b>BIS0104</b>	BIS M-400-072-002-07-S4	168
<b>BIS0105</b>	BIS M-402-072-002-07-S4	168
<b>BIS0106</b>	BIS M-402-072-004-07-S4	167
<b>BIS0108</b>	BIS M-400-072-001-07-S4	167
<b>BIS010P</b>	BIS V-6111-073-C003	163

<b>BNI</b>		
<b>BNI0001</b>	BNI-DNT-104-000-Z004	77
<b>BNI0002</b>	BNI-DNT-202-000-Z005	77
<b>BNI0003</b>	BNI-DNT-302-000-Z005	77
<b>BNI0004</b>	BNI-DNT-305-000-Z005	78
<b>BNI0005</b>	BNI IOL-102-000-K006	150
<b>BNI0006</b>	BNI IOL-104-000-K006	150
<b>BNI0007</b>	BNI IOL-709-000-K006	151
<b>BNI0008</b>	BNI IOL-710-000-K006	151
<b>BNI000F</b>	BNI EIP-950-000-Z009	130
<b>BNI000P</b>	BNI IOL-101-000-K018	140
<b>BNI000R</b>	BNI IOL-102-000-K019	140
<b>BNI000Z</b>	BNI-PBS-507-000-Z011	201
<b>BNI0014</b>	BNI EIP-104-100-Z016	104
<b>BNI0015</b>	BNI EIP-202-100-Z016	104
<b>BNI0016</b>	BNI EIP-206-100-Z016	104
<b>BNI0017</b>	BNI EIP-305-100-Z016	104
<b>BNI0018</b>	BNI EIP-105-100-Z010	104
<b>BNI0019</b>	BNI EIP-306-100-Z010	104
<b>BNI001E</b>	BNI IOL-750-V02-K007	181
<b>BNI001F</b>	BNI IOL-750-V01-K007	181
<b>BNI001H</b>	BNI IOL-750-V03-K007	181
<b>BNI001J</b>	BNI IOL-750-V04-K007	181
<b>BNI001K</b>	BNI IOL-751-V01-K007	181
<b>BNI001L</b>	BNI IOL-751-V02-K007	181
<b>BNI001M</b>	BNI IOL-751-V03-K007	181
<b>BNI001N</b>	BNI IOL-751-V04-K007	181
<b>BNI001W</b>	BNI IOL-101-S01-K018	142
<b>BNI001Y</b>	BNI IOL-102-S01-K019	142
<b>BNI0021</b>	BNI IOL-104-000-K021	141
<b>BNI0022</b>	BNI IOL-104-S01-K021	143
<b>BNI002A</b>	BNI CCL-302-100-Z001	65
<b>BNI002C</b>	BNI CCL-305-100-Z001	65
<b>BNI002E</b>	BNI CCL-202-100-Z001	65
<b>BNI002F</b>	BNI CCL-104-100-Z001	65
<b>BNI002U</b>	BNI USB-901-000-A501	188
<b>BNI002Z</b>	BNI IOL-530-000-K006	201
<b>BNI0030</b>	BNI PBS-504-002-K008	27
<b>BNI0032</b>	BNI IOL-104-000-Z012	145
<b>BNI0033</b>	BNI IOL-252-000-Z013	149
<b>BNI0034</b>	BNI IOL-256-000-Z013	149
<b>BNI0035</b>	BNI IOL-302-000-Z013	145
<b>BNI0039</b>	BNI IOL-104-S01-Z012	146
<b>BNI003A</b>	BNI IOL-302-S01-Z013	147
<b>BNI003C</b>	BNI IOL-302-S01-Z012	147
<b>BNI003P</b>	BNI-PBS-507-002-Z011	26
<b>BNI003T</b>	BNI IOL-104-S01-Z012-C01	146
<b>BNI003U</b>	BNI IOL-302-000-Z012	145
<b>BNI003W</b>	BNI IOL-252-S01-Z013	149





# Worldwide sales

## Headquarters

### Germany

Balluff GmbH  
Schurwaldstrasse 9  
73765 Neuhausen a.d.F.  
Phone +49 7158 173-0  
Fax +49 7158 5010  
balluff@balluff.de

## Subsidiaries and Representatives

### Argentina

Balluff Argentina S.R.L.  
Echeverría 1050, 1st UF 2  
1604 Florida Oeste,  
Buenos Aires  
Phone +54 11 4730-4544  
Fax +54 11 4730-3908

### Australia

Balluff-Leuze Pty. Ltd.  
12 Burton Court  
Bayswater VIC 3153  
Phone +61 397 204100  
Fax +61 397 382677  
sales@balluff.com.au

### Austria

Balluff GmbH  
Industriestraße B16  
2345 Brunn am Gebirge  
Phone +43 2236 32521-0  
Fax +43 2236 32521-46  
sensor@balluff.at

### Belarus

Automaticcentre OOO  
Nezavisimosti Av. 185,  
Block 19, Office 3  
220125 Minsk  
Phone +375 17 2838940  
Fax +375 17 2181798  
info@automatica.by

### Belgium

Balluff bvba  
Researchpark Haasrode 1820  
Interleuvenlaan 62,  
3001 Leuven  
Phone +32 16 397800  
Fax +32 16 397809  
info.be@balluff.be

### Brazil

Balluff Controles  
Elétricos Ltda.  
Rua Francisco Foga, 25  
Distrito Industrial  
CEP 13280.000  
Vinhedo – Sao Paulo  
Phone +55 19 38769999  
Fax +55 19 38769990  
balluff@balluff.com.br

### Bulgaria

BPS AG  
41, Nedelcho Bonchev St.  
1528 Sofia  
Phone +359 2 9609875  
Fax +359 2 9609896  
bps@bps.bg

### Canada

Balluff Canada Inc.  
2840 Argentia Road, Unit 2  
Mississauga, Ontario L5N 8G4  
Phone +1 905 816-1494  
Toll-free 1-800-927-9654  
Fax +1 905 816-1411  
balluff.canada@balluff.ca

### Chile

Balluff Controles  
Eléctricos Ltda.,  
Brazil

### China

Balluff (Shanghai) Trading Co., Ltd.  
8F, Building A, Yunding International  
Commercial Plaza,  
No. 800 Chengshan Rd,  
Pudong, Shanghai, 200125  
Phone +86 21 5089 9970  
Fax +86 21 5089 9975  
info@balluff.com.cn

### Columbia

Balluff Controles  
Eléctricos Ltda.,  
Brazil

### Croatia

HSTEC d.d.  
Zagrebacka 100  
23000 Zadar  
Phone +385 23 205-405  
Fax +385 23 205-406  
info@hstec.hr

### Czech Republic

Balluff CZ, s.r.o  
Pelušková 1400  
198 00 Praha 9 – Kyje  
Phone +420 281 000 666  
Fax +420 281 940066  
obchod@balluff.cz

### Denmark

Balluff ApS  
Åbogade 15  
8200 Århus N  
Phone +45 70 234929  
Fax +45 70 234930  
info.dk@balluff.dk

### Egypt

EGEC  
24 St., 302 Taksym El Kodah-smouha,  
First Floor, Department 1  
Alexandria  
Phone +20 3 4299771  
Fax +20 3 4261773  
info@egecgroup.com

### Finland

Murri Oy  
Koukkukatu 1  
15700 Lahti  
Phone +358 3 8824000  
Fax +358 3 8824040  
myynti@murri.fi

### France

Balluff SAS  
5 Rue des Vieilles Vignes  
Bâtiment A  
77183 Croissy Beaubourg  
Phone 01 64 11 19 90  
Fax 01 64 11 19 91  
info.fr@balluff.fr

### Greece

S. NAZOS S.A.  
10 KLM Thessalonikis-Kilkis  
P.O. Box 57008  
Thessaloniki  
Phone +30 2310 462120  
Fax +30 2310 474079  
parasos@nazos.gr

### Hong Kong

Sensortech Company  
No. 43, 18th Street  
Hong Lok Yuen,  
Tai Po, NT  
Phone +852 26510188  
Fax +852 26510388  
sensortech@netvigator.com

### Hungary

Balluff Elektronika Kft.  
Pápai út. 55.  
8200 Veszprém  
Phone +36 88 421808  
Fax +36 88 423439  
saleshu@balluff.hu

### Iceland

Smith & Norland  
Nóatúni 4  
105 Reykjavík  
Phone +354 520 3000  
Fax +354 520 3011  
olaf@sminor.is

### India

Balluff India  
405 Raikar Chambers  
Deonar Village Road,  
Govandi, Mumbai 400088  
Phone +91 22 25568097  
Fax +91 22 25560871  
balluff@balluff.co.in

### Indonesia

PT. Multiguna Cemerlang  
Bumi Serpong Damai Sektor XI  
Multipurpose Industrial Building  
Block H 3-31  
Serpong Tangerang  
15314 Banten  
Phone +62 21 75875555  
Fax +62 21 75875678  
sales\_bsd@multigunacemerlang.com

### Israel

Ancitech Ltd.  
19, Hamashbir St.  
Industrial Zone Holon  
58853 Holon  
Phone +972 3 5568351  
Fax +972 3 5569278  
tuvia@ancitech.com

### Italy

Balluff Automation s.r.l.  
Via Morandi 4  
10095 Grugliasco, Torino  
Phone +39 11 3150711  
Fax +39 11 3170140  
info.italy@balluff.it

### Japan

Balluff Co., Ltd.  
Aqua Hakusan Bldg. 9F  
1-13-7 Hakusan, Bunkyo-ku,  
Tokyo 113-0001  
Phone +81 3 3830-0520  
Fax +81 3 3830-0519  
info.jp@balluff.jp

### Kazakhstan

elcos electric control systems  
2A, Molodezhnyi Str. 3D  
Block O., Offices 318-319  
050061 Almaty  
Phone +7 727 3340536  
Fax +7 727 3340539  
info@elcos.kz

### Latvia and Estonia

SIA Interautomatika  
Brīvības g. 410  
1024 Rīga  
Phone +371 67522010  
Fax +371 67522007  
info@interautomatika.lv

### Lithuania

UAB Interautomatika  
Kęstučio 47  
08127 Vilnius  
Phone +370 5 2607810  
Fax +370 5 2411464  
andrius@interautomatika.lt

### Malaysia

Profacto Solution & Services Sdn. Bhd.  
No. 23-1 Jalan Bandar Empat Balas  
Pusat Bandar Puchong,  
47100 Puchong, Selangor  
Phone +60 35882 2684  
Fax +60 35882 2685  
ckkkyyong@streamyx.com

Team Automation Systems (M) Sdn. Bhd.  
2A, Jalan MP17, Taman Merdeka Permai,  
Batu Berendam, 75250 Melaka  
Phone +60 6 3366223  
Fax +60 6 3368223  
sales@teamtas.com.my

### Mexico

Balluff de México S.A. de C.V.  
Anillo Vial II Fran Junipero Serra No. 4416  
Colonia La Vista Residencial, CP 76232  
Delegación Epigmenio González  
Queretaro, Qro.  
Phone +52 442 2124882  
Fax +52 442 2140536  
balluff.mexico@balluff.com

### Netherlands

Balluff B.V.  
Europalaan 6a  
5232 BC 's-Hertogenbosch  
Phone +31 73 6579702  
Fax +31 73 6579786  
info.nl@balluff.nl

### New Zealand

Balluff-Leuze Pty. Ltd.,  
Australia

**Norway**

Primatec as  
Lillesandsveien 44  
4877 Grimstad  
Phone +47 37 258700  
Fax +47 37 258710  
post@primatec.no

**Philippines**

Technorand Sales Corporation  
122 McArthur Highway  
Malabon, Metro Manila  
Phone +632 7245006  
Fax +632 7245010  
technorand@gmail.com

**Poland**

Balluff Sp. z o.o.  
Ul. Muchoborska 16  
54-424 Wroclaw  
Phone +48 71 3384929  
Fax +48 71 3384930  
balluff@balluff.pl

**Portugal**

LA2P Lda.  
Rua Teofilo Braga, 156 A  
Escrit. F – Edificio S. Domingos  
Cabeco Do Mouro  
2785-122 S. Domingos De Rana  
Phone +351 21 4447070  
Fax +351 21 4447075  
la2p@la2p.pt

**Romania**

Balluff Automation SRL  
Strada Industriilor Nr. 56.,  
Bloc 1, Etaj 1  
032901 Bucuresti Sector 3  
Phone +40 374 926252  
Fax +40 374 097 423  
office@balluff.com.ro

**Russia**

Balluff OOO  
M. Kaluzhskaya Street 15  
Building 17, Office 500  
119071 Moscow  
Phone +7 495 78071-94  
Fax +7 495 78071-97  
balluff@balluff.ru

**Serbia**

ENEL d.o.o.  
Ul. Vasilja Pavlovica 10  
14000 Valjevo  
Phone +381 14 291161  
Fax +381 14 244641  
enelvaljevo@gmail.com

**Singapore**

Balluff Asia Pte. Ltd.  
18 Sin Ming Lane  
#06-41 Midview City,  
Singapore 573960  
Phone +65 62524384  
Fax +65 62529060  
balluff@balluff.com.sg

**Slovakia**

Balluff Slovakia s.r.o.  
Blagoevova 9  
85104 Bratislava  
Phone +421 2 67200062  
Fax +421 2 67200060  
info@balluff.sk

**Slovenia**

Senzorji SB d.o.o.,  
Proizvodnja,  
trgovina in storitve d.o.o.  
Livadna ulica 1  
2204 Miklavž na Dravskem polju  
Phone +386 2 6290300  
Fax +386 2 6290302  
senzorji.sb@siol.net

**South Africa**

PAL Distributors CC  
291A Pine Avenue, Ferndale  
Randburg, Gauteng  
Phone +27 11 7814381  
Fax +27 11 7818166  
pal@polka.co.za

**South Korea**

Mahani Electric Co. Ltd.  
792-7 Yeoksam-Dong  
Gangnam-Gu, Seoul  
Post code: 135-080  
Phone +82 2 21943300  
Fax +82 2 21943397  
yskim@hanmec.co.kr

**Spain**

Balluff S.L.  
Edificio Forum SCV  
Planta 5°, Oficina 4°  
Carretera Sant Cugat a Rubi  
Km01, 40-50  
08190 Sant Cugat del Vallés  
Barcelona  
Phone +34 93 5441313  
Fax +34 93 5441312  
info.es@balluff.es

**Sweden**

Balluff AB  
Gamlestadsvägen 2, B19  
41502 Göteborg  
Phone +46 31 3408630  
Fax +46 31 3409431  
info.se@balluff.se

**Switzerland**

Balluff Sensortechnik AG  
Riedstrasse 6  
8953 Dietikon  
Phone +41 43 3223240  
Fax +41 43 3223241  
sensortechnik@balluff.ch  
info@balluff.ch

**Taiwan**

Canaan Electric Corp.  
6F-5, No. 63 Sec. 2  
Chang An East Road  
10455 Taipei  
Phone +886 22 5082331  
Fax +886 22 5084744  
sales@canaan-elec.com.tw

**Thailand**

Compomax Co. Ltd.  
16 Soi Ekamai 4,  
Sukhumvit 63 Rd.  
Prakanongnua, Vadhana,  
Bangkok 10110  
Phone +66 2 7269595  
Fax +66 2 7269800  
info@compomax.co.th

**Turkey**

Balluff Sensor Otomasyon  
Sanayi Ve Ticaret Ltd. Sti.  
Perpa Ticaret Is Merkezi  
A Blok, Kat 1-2-3  
No: 0013-0014  
34381 Okmeydani/Istanbul  
Phone +90 212 3200411  
Fax +90 212 3200416  
balluff@balluff.com.tr

**Ukraine**

Micronlogistik Ltd.  
Ul. Promyischlennaya Street 37  
65031 Odessa  
Phone +380 48 7781278  
Fax +380 48 2358760  
info@balluff-ua.com

**United Arab Emirates**

Multiline Technical Co.  
TCA, behind ADCB Bank  
46530 Abu Dhabi  
Phone +971 2 6457760  
Fax +971 2 6459761  
multiline@emirates.net.ae

**United Kingdom and Ireland**

Balluff Ltd.  
4 Oakwater Avenue  
Cheadle Royal Business Park  
Cheadle, Cheshire SK8 3SR  
Phone +44 161 282-4700  
Fax +44 161 282-4701  
sales@balluff.co.uk

**USA**

Balluff Inc.  
8125 Holton Drive  
Florence, KY 41042-0937  
Phone +1 859 727-2200,  
Toll-free 1-800-543-8390  
Fax +1 859 727-4823  
balluff@balluff.com

**Venezuela**

Balluff Controles  
Eléctricos Ltda.,  
Brazil

**Vietnam**

Anh Nghi Son Service Trading Co., Ltd.  
D3 KDC Mieu Noi Dinh Tien Hoang St.,  
W3, Binh Thanh Dist.,  
Ho Chi Minh City  
+84 8 35170401  
+84 8 35170403  
ans.vina@gmail.com



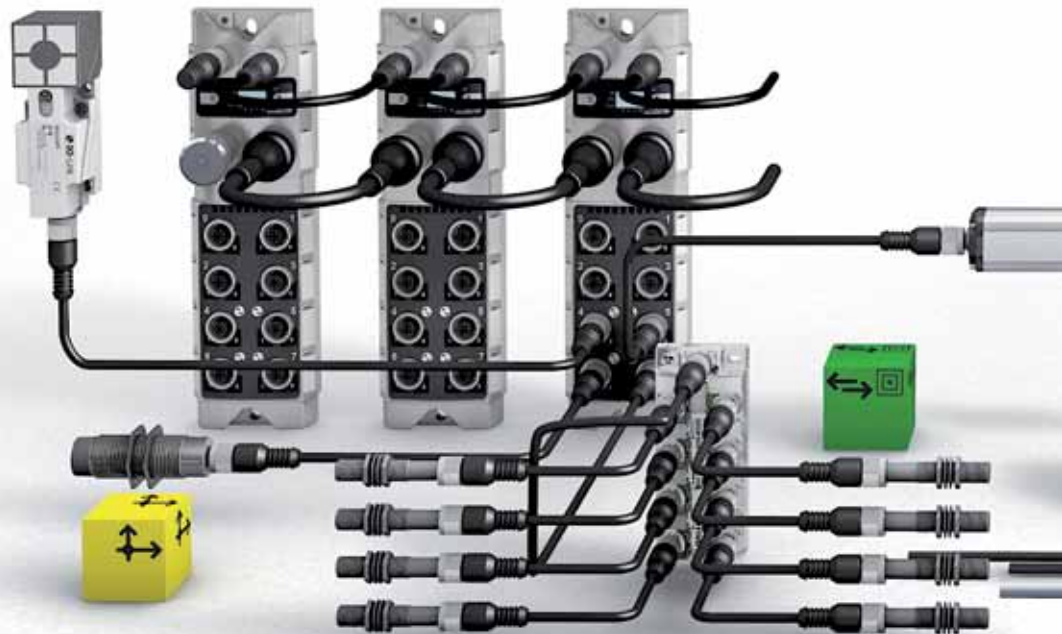

Your added value  
for planning  
and commissioning

**Selection**  
**Integration**  
**Instruction**  
**Application**  
**Industrial Identification**  
**Project support**  
**Vision sensors**  
**IO-Link**  
**Industrial Networking**  
**and Connectivity**  
**Product**  
**System components**  
**Decision help**

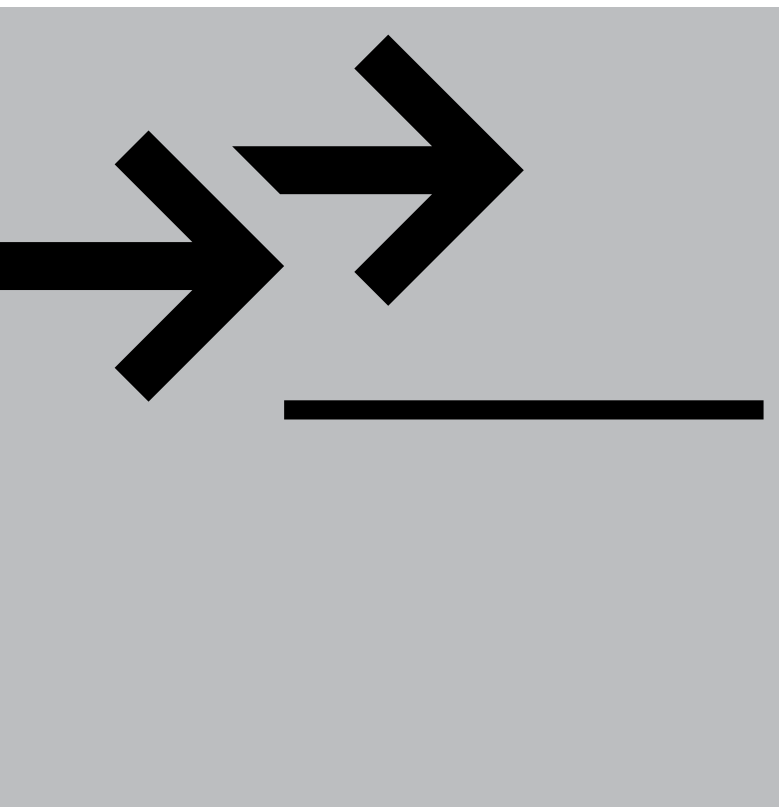

**Tec**



■ **We offer ...**

- Decision help for the correct product selection
- Complex product and application support
- Integration support
- Customer-specific product and commissioning training
- Intensive technical support during the entire phase of the project
- Assumption of time-consuming project work

**We support you during the project implementation, commissioning and integration**

- Would you like to monitor and track production processes?
- Would you like to identify, control, monitor and optimize objects?
- Would you like to optimize and simplify your system wiring?

**We provide you with specific support for Balluff system components**

- Vision sensors BVS for optical identification
- Industrial networking and connectivity for wiring and networking
- IO-Link – network technology for reliable data transfer and greater efficiency
- Industrial identification – RFID for transparency in material flow

**We are happy to help!**

Phone +49 7158 173-401

+49 7158 173-727

E-mail [TecSupport@balluff.de](mailto:TecSupport@balluff.de)

# Support







# Customized Services

**According to your specifications. In the best quality.**

Balluff offers highly efficient sensor technology with high-performance mini sensors and compact connection technology. And more. Because with our extensive services, you can obtain support direct from the manufacturer: from the design and planning of your projects, to testing and setup on-site, to training and support. Over the entire life cycle of our products.

This creates greater planning security and provides faster commissioning and an earlier start of production. This leads to higher productivity and more cost-effectiveness. And this relieves you of additional stress in your everyday work, giving you more time to focus on your core business.



You can find more information in our Services brochure or send us an e-mail: [tsm.de@balluff.com](mailto:tsm.de@balluff.com)

<p><b>Application advice through our TecSupport:</b> Discuss your technical requirements. And take advantage of our expertise.</p>	<p>Real-world examples:</p> <ul style="list-style-type: none"> <li>■ Selection of the correct identification procedure for an assembly line</li> <li>■ IO-Link concept as a cost-effective alternative to conventional wiring</li> <li>■ System consulting for radio frequency identification (RFID): identification of large steel pipes in adverse environments</li> <li>■ Recognizing multiple containers on a pallet in goods receiving</li> </ul>
<p><b>Commissioning:</b> Order expert knowledge. And benefit from a quick start of production.</p>	<p>Real-world examples:</p> <ul style="list-style-type: none"> <li>■ Setting up an optical checkpoint with the vision sensor BVS</li> <li>■ Consulting and support during the programming of RFID systems BIS</li> <li>■ Installation and commissioning of a color detection application with the color sensor BFS</li> </ul>
<p><b>Fully customized products:</b> Order individual versions according to your requirements: from preassembly to engineering services. And take advantage of the optimum.</p>	<p>Real-world examples:</p> <ul style="list-style-type: none"> <li>■ Extending the housing of a high-pressure resistant inductive sensor BHS</li> <li>■ Extra threads for the housing cover of a micropulse transducer BTL</li> <li>■ Customer-specific holder for an RFID data carrier</li> <li>■ Adaptation of the characteristics for analog sensors BAW</li> </ul>
<p><b>Workshops:</b> Make use of well-founded manufacturer expertise. And benefit from application security.</p>	<ul style="list-style-type: none"> <li>■ <b>Professional sensor use:</b> Select operating principles, install sensors professionally and ensure the reliable operation of your application.</li> <li>■ <b>Position and Distance Measurement:</b> This is how you perform precise and wear-free measurements.</li> <li>■ <b>RFID:</b> The right data at the right time at the right place.</li> <li>■ <b>Vision sensor:</b> Using an image processing sensor, ensure manufacturing quality in three steps.</li> <li>■ <b>Vision sensor identification:</b> Reliably identify data matrix codes with an image-processing sensor.</li> <li>■ <b>Industrial networking with IO-Link:</b> Manage signals intelligently and cost-effectively.</li> </ul>

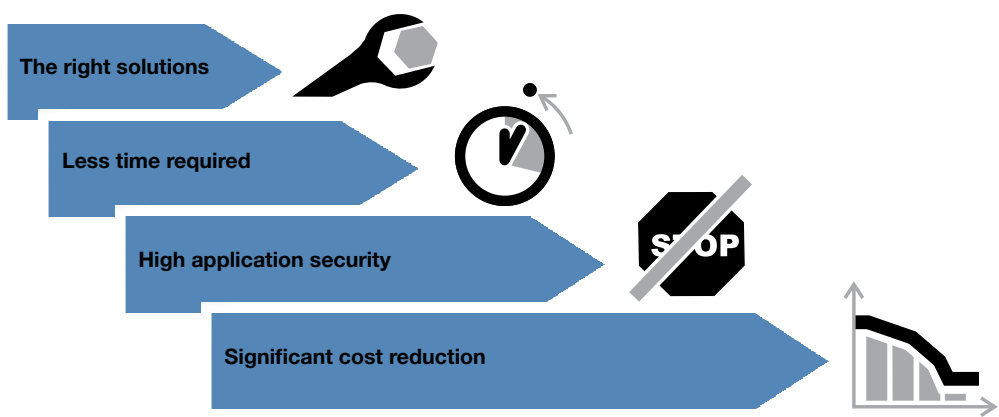

# Balluff Products in 3D

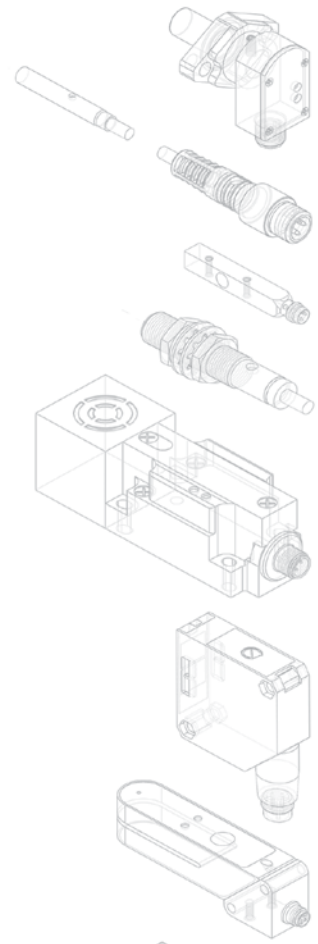
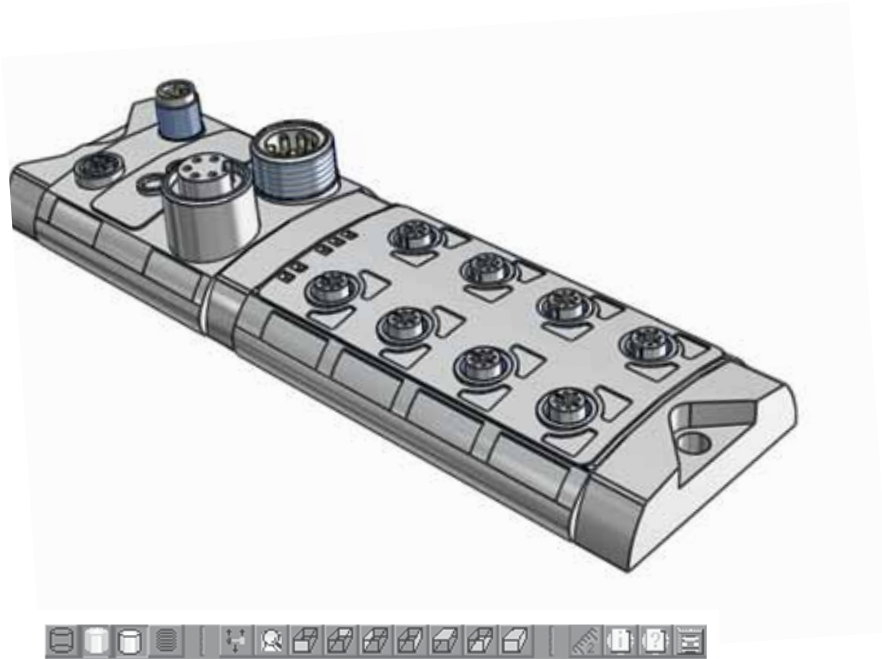

- All catalog products are available: inductive sensors, photoelectric sensors, sensors for pneumatic cylinders, micropulse transducers, industrial RFID systems, vision sensors BVS, mechanical single and multiple position switches, industrial networking and connectivity, and so on.
- sizephics reduced to the essentials for optimized performance

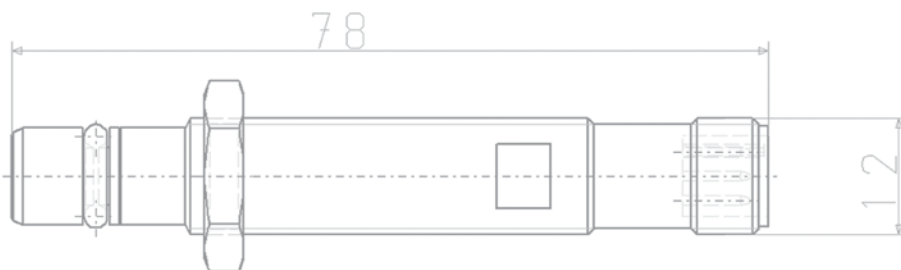
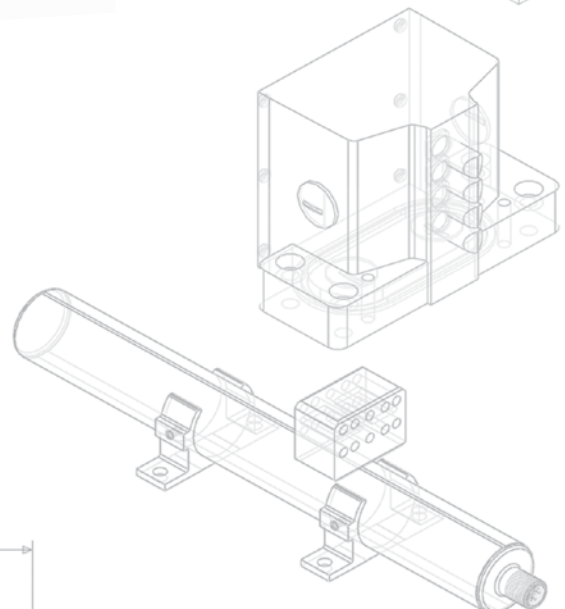

## CAD formats on the Cadenas PARTserver



# Retrieving Product Information Online

## Various CAD and electronic diagram formats available

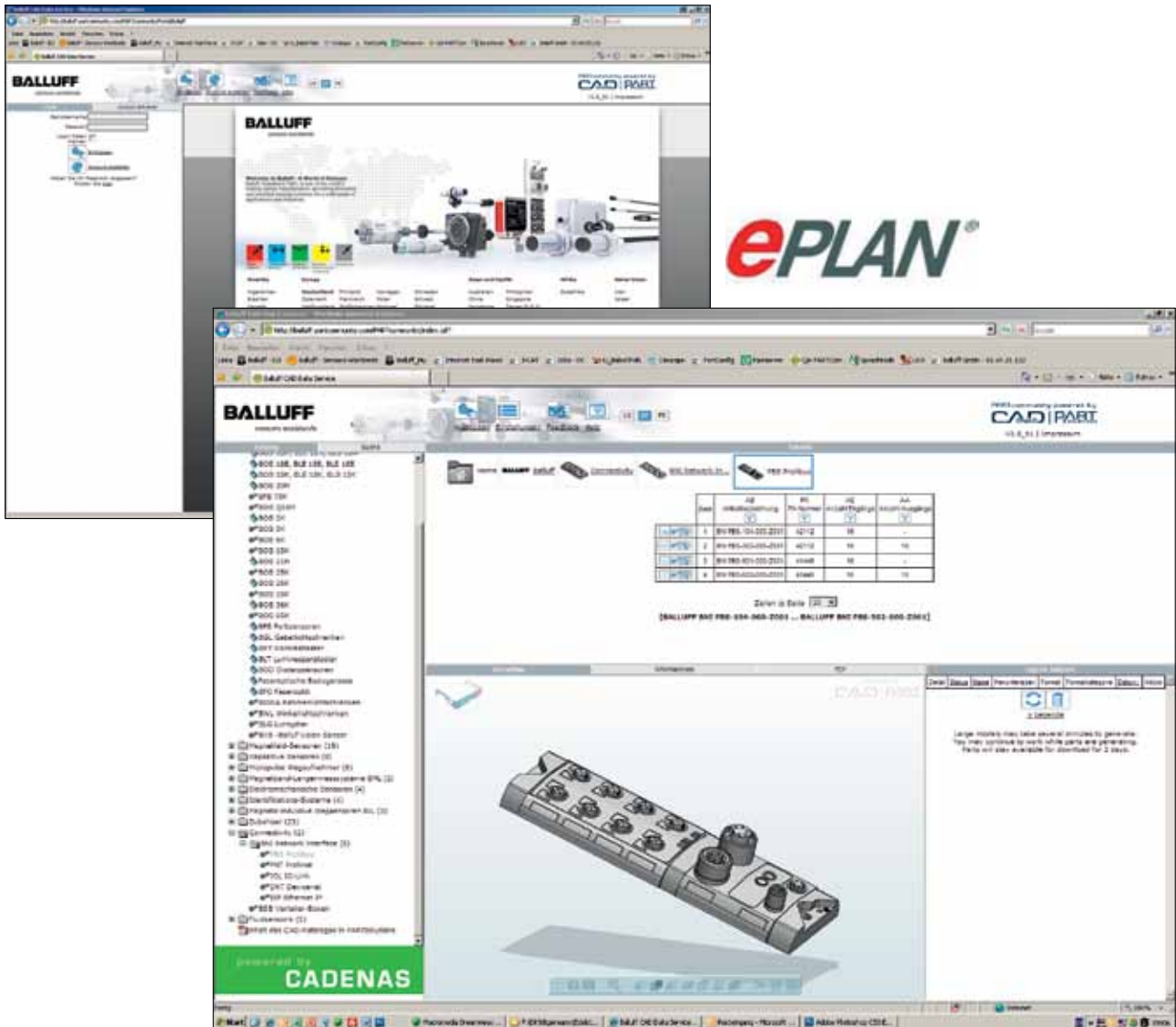

### The benefits to you

- Faster and more efficient designing
- Free availability of all Balluff catalog products
- All common CAD formats
- Convenient preview in 3D
- Configurable products

### And here is how it works

- Go to the 3D data at [www.balluff.com](http://www.balluff.com)
- You are redirected to the Cadenas PARTserver
- Select a sensor and perform an optional check via 3D preview
- Add it to the shopping cart
- Once you have entered your details, the CAD files of your choice are sent to you by e-mail

### EPLAN macros – Electrical project planning made easy

And now users of EPLAN electrical project planning software can also profit from this free service. On our Web site planners and designers can download macros for selected Balluff products at no charge and implement them in their design. These macros include all the necessary graphics, technical and commercial information for the electrical design and documentation. Benefit from significant time and cost savings.

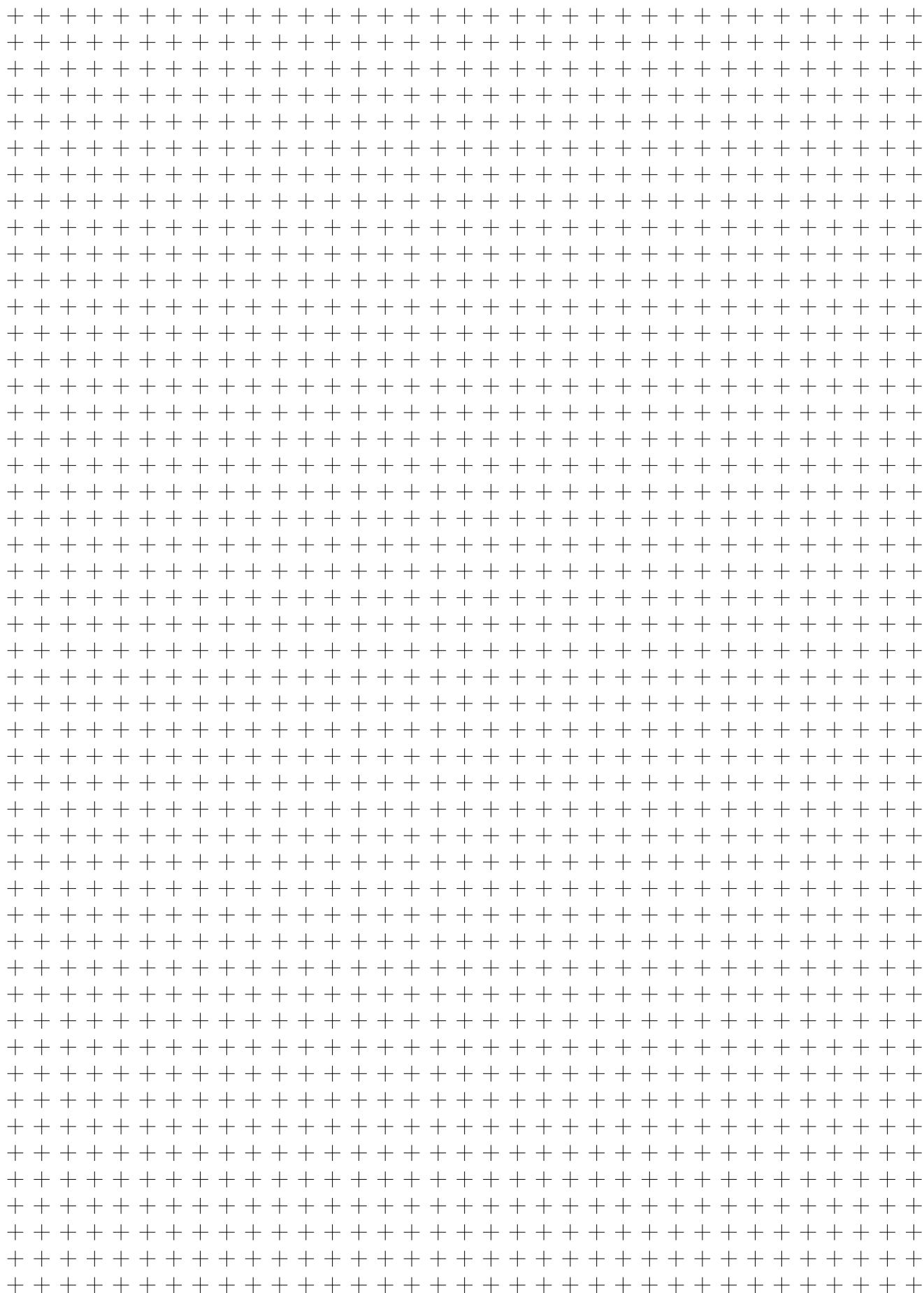

# SENSOR SOLUTIONS AND SYSTEMS

## For all areas of the automation industry

As a global player, we stand for comprehensive system expertise, continuous innovation, the highest quality and the greatest reliability. Balluff means technological variety and first-class service. Our 2450 worldwide employees are working to ensure this.

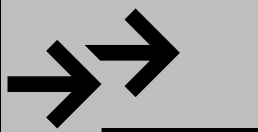

Systems  
and Service



Industrial  
Networking and  
Connectivity



Industrial  
Identification



Object  
Detection

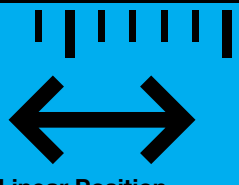

Linear Position  
Sensing and  
Measurement

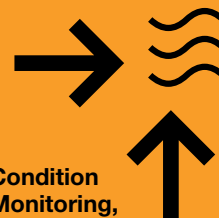

Condition  
Monitoring,  
Fluid Sensors



Accessories

# BALLUFF

sensors worldwide



Systems and Service



Industrial Networking and Connectivity



Industrial Identification



Object Detection



Linear Position Sensing and Measurement



Condition Monitoring and Fluid Sensors



Accessories

## Headquarters

Balluff GmbH  
Schurwaldstrasse 9  
73765 Neuhausen a.d.F.  
Germany  
Phone +49 7158 173-0  
Fax +49 7158 5010  
balluff@balluff.de

Balluff GmbH  
Industriestraße B16  
2345 Brunn am Gebirge  
Österreich  
Tel. +43 2236 32521-0  
Fax +43 2236 32521-46  
sensor@balluff.at

Balluff Sensortechnik AG  
Riedstrasse 6  
8953 Dietikon  
Schweiz  
Tel. +41 43 3223240  
Fax +41 43 3223241  
sensortechnik@balluff.ch



[www.balluff.com](http://www.balluff.com)